



vivanext

Yonge Subway Extension Conceptual Design Services

Contract Y85-9

Conceptual Design Report

FINAL

March 2012



YONGE SUBWAY EXTENSION CONCEPTUAL DESIGN SERVICES CONCEPTUAL DESIGN REPORT

Executive Summary

The Yonge Subway Extension (YSE) Transit Project Assessment Process (TPAP) was approved by the Province in April 2009

On June 15, 2007, the Province of Ontario announced \$17.5 billion in funding for transit project for the Greater Toronto Area and Hamilton. Named “MoveOntario 2020”, the provincial transit plan includes funding for an extension of the Yonge Subway from its current terminus at Finch Station in the City of Toronto to Highway 7 (Richmond Hill Centre) in the Town of Richmond Hill.

On June 21, 2007, York Region Council authorized commencement of a Functional Planning Study in coordination with the TTC and the City of Toronto for the timely extension of the subway.

On October 3, 2008, following completion of the Functional Planning Study, York Region initiated the TPAP for the YSE project (the Transit Project). At the end of October, 2008, the TTC and the City of Toronto became co-proponents of the Transit Project. Final approval of the YSE TPAP submission was received from the Ontario Minister of the Environment on April 7, 2009.

Metrolinx completed the initial Benefits Case Analysis (BCA) for the YSE based on the findings of the TPAP in July 2009

The Metrolinx Board received the July 2009 BCA and directed staff to undertake additional analysis related to the YSE project. The additional analysis was to examine the following areas:

1. Possible adjustments in timing or phasing of the subway extension.
2. Review of the need for some stations in order to reduce capital costs.
3. Consideration of the parallel GO Richmond Hill rail corridor to off-load some of the demand on Yonge Street.
4. The costs impacts of the various options on the subway yards strategy, Bloor-Yonge subway station improvements, and a future Downtown Relief Line to bypass the Bloor-Yonge congestion “pinch point” (Metrolinx Board report – July 23, 2009).

Additional conceptual design work and network planning was required in order to address issues that might arise out of Metrolinx’ analysis.

Work was initiated on the YSE Conceptual Design Study to maintain a state of readiness and to address outstanding issues from the initial Metrolinx BCA

In October 2009, the Regional Municipality of York and the City of Toronto authorized York Region Rapid Transit Corporation (YRRTC) and the Toronto Transit Commission (TTC) to proceed with the Conceptual Design Study for the Yonge Subway Extension. The Joint Venture of McCormick Rankin Corporation and Hatch Mott MacDonald was retained by the TTC and YRRTC to carry out the work. The purpose of the study is to undertake the additional analysis resulting from the July 2009 Metrolinx BCA, including an update of the projected ridership and estimated capital costs. The Conceptual Design Study also continues to advance the design of the YSE project to maintain a state of readiness for implementation.

GENERAL DESCRIPTION

The YSE project is 7.42km in length and it is primarily underground with the exception of the crossing of the East Don River

The YSE project is 7.42km in length with 1.61km in the City of Toronto (south of Steeles Avenue) and 5.81km in York Region (north of Steeles Avenue). The project comprises a total of 5.08km of twin-bored tunnel, five stations, two major bus terminals, two bus loops, five substations, eight emergency exit buildings (EEBs), one bridge, six cross passages, 513m of twin or triple box structure and an 831m below grade triple track train storage facility north of the Richmond Hill Centre Station. There are three sections of special trackwork: the extension of the Finch Tail Tracks, the crossover south of Steeles Station, and the crossover south of Richmond Hill Station.

The alignment is underground for its entire length with the exception of the crossing of the East Don River where the subway emerges from the tunnels and crosses through the river valley via a two-level bridge – with auto traffic on the upper level and subway on the lower level. The subway level of the bridge will be enclosed to maintain the integrity of the tunnel ventilation system and to mitigate against noise transfer to the surrounding community.

Between Finch Station and Langstaff Station, the alignment runs north below Yonge Street. North of Langstaff Station, two reverse curves are provided to divert the subway to the east of Yonge Street to the preferred location for Richmond Hill Centre Station. Slight modifications have been made to these curves since the TPAP to allow the Langstaff Station to shift as far north as possible to best serve the Langstaff Gateway development.

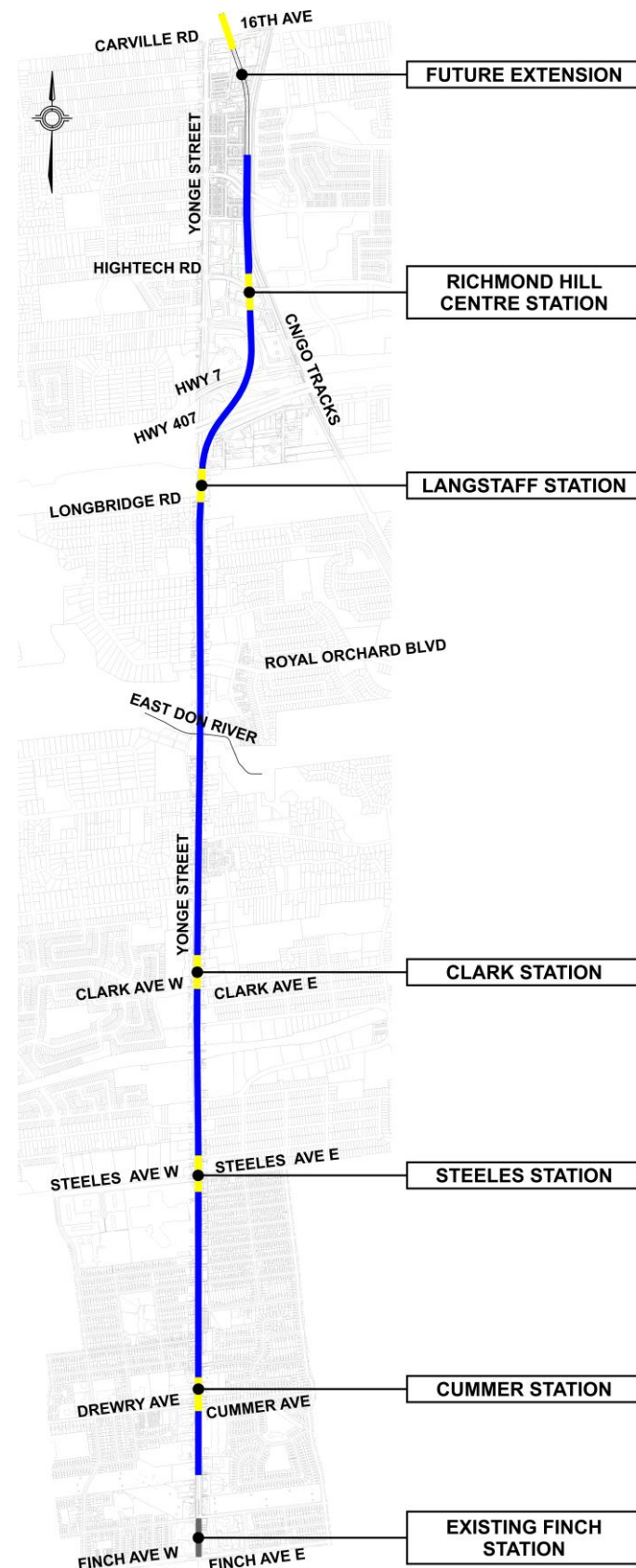

The operational design basis is to minimize the time between trains with every other Yonge Subway train to continue north from Finch Station to Richmond Hill Centre Station with an average headway of 3.5 minutes (210 seconds) during the peak hour and assuming Automatic Train Operation (ATO). As passenger volumes increase, the design protects for the ability to operate every train to RHC.

PASSENGER DEMAND

Projected ridership at Richmond Hill Centre Station increased 25 percent relative to the TPAP

The projected transit ridership – developed during the TPAP – was updated during the Conceptual Design Study to reflect revised 2031 land use projections from York Region and the City of Toronto. Results suggest that more people (about a 25% increase) will board the subway at Richmond Hill Centre Station during the morning peak hour in 2031 than previously projected during the TPAP. The resultant increase reflects the implications of new secondary plans and development applications received since the completion of the TPAP in 2009. Based on current analysis, it is projected that ridership volumes in the Yonge corridor will warrant a subway within the next 10 years (i.e. before the year 2021). The minimum ridership required to warrant a subway is approximately 10,000 passengers during the peak hour. Within the next 10 years, over 12,000 peak hour passengers are expected to board or depart at RHC station alone. By 2031, ridership at RHC is expected to increase to 14,000 peak hour passengers.

STATION DESIGN PHILOSOPHY

The station design philosophy is to provide high quality architecture, urban design, streetscape, and landscape architecture with:

- potential for increased Transit Oriented Development (TOD), with entrances that can be incorporated into future development as economically as possible
- Sustainable above and below grade facilities which minimize negative impact on the environment
- Clearly identifiable entrance facilities that allow daylight to penetrate to lower levels where economically feasible
- Urban gateways at Steeles Avenue and at Langstaff Gateway/Richmond Hill Centre
- Circulation routes to vehicle boarding points that are convenient, intuitive, straight forward, well signed, comfortable, and well lit
- Obvious and convenient intermodal transfers.
- Train and bus platform areas that offer an attractive environment, visual diversions to help pass the time, such as public art, architectural design, televised media, advertising etc.

- Emergency egress routes which are clear, convenient, and safe
- At least one barrier-free accessible entrance

CUMMER STATION

The conceptual layout for Cummer Station remains largely the same relative to the TPAP

The length of the station box has been increased by about 20m as a result of conflict with an underground storm sewer. This conflict necessitates a modification of the station's ventilation configuration which resulted in a lengthening of the station box.

Analysis carried out during the Conceptual Design Study has shown that an electrical substation, providing traction power to the subway, will be required at Cummer Station. The substation is currently shown above the Main Entrance building in the northeast corner of the Yonge Street/Cummer Avenue intersection.

STEELES STATION

Steeles Station still includes an underground bus terminal but the design has evolved to connect all four quadrants of the Yonge/Steeles intersection with a public concourse

The total number of bus bays at the station has been reduced from 25 to 16 bays by relocating some of the YRT routes from Steeles Station to Clark Station. As a result, there is no longer a need to provide a portal on Yonge Street for YRT buses to access the underground bus terminal from the north. A new concourse level, connecting all four quadrants of the Yonge/Steeles intersection, has been added to the previous two-level concept developed during the TPAP. The new concourse will be situated one level underground and directly above the underground bus terminal. The design recognizes the constraint posed by the York-Durham Sewage System infrastructure located within the Steeles Avenue right-of-way.

The design team has met with the land owner of Centerpoint Mall in the City of Toronto to discuss opportunities for a relocated bus terminal in the southwest quadrant of the Yonge/Steeles intersection. This could be explored further as part of the next stage of design.

CLARK STATION

The conceptual layout for Clark Station has evolved to include a bus loop which is incorporated as part of the already planned combined entrance and electrical substation building

To improve passenger connections to the subway, a small bus loop with three bus bays has been incorporated as part of the main entrance building and electrical substation which were identified in the TPAP. The bus loop allows

YRT customers to access the subway sooner, rather than travelling further south in mixed traffic on Yonge Street to Steeles Station as was proposed in the TPAP. The proposed bus loop at Clark Station reduces the number of bus bays required at Steeles Station and eliminates the need for a portal on Yonge Street for YRT buses to access the underground bus terminal at Steeles Station.

EAST DON RIVER BRIDGE

The East Don River (EDR) Bridge has been advanced to better understand the engineering constraints and opportunities

A number of structurally and operationally acceptable options were developed during the Conceptual Design Study to inform decisions with respect to capital cost estimates. The design options considered a number of engineering issues including; issues associated with the railway enclosure, the transparency of the structure, the height of the road, the central span of the valley, constructability, capital and operational costs, etc. The long list of options was narrowed down to a short list of options which will frame discussions during the next stage of design for the incorporation of heritage aspects. Based on geotechnical concerns associated with the tunnelling under the EDR option, the EDR bridge is required regardless of whether Royal Orchard Station is included as part of the project.

ROYAL ORCHARD STATION

Based on limited redevelopment opportunities and low ridership projections, it is recommended that Royal Orchard Station be removed from the YSE project

Future redevelopment potential in the area of the proposed station is limited as a result of its location within the Vaughan Thornhill Heritage Conservation District and the established high and low density residential property fabrics which inhibit intensification on the Markham side. The limited redevelopment and land growth opportunities result in the projected subway ridership volume being too low to justify the expense of building and operating a subway station. The projected 2031 morning peak hour ridership at the station is 350 passengers, which is approximately two-thirds the current ridership of Bessarion Station on the Sheppard Subway, which is the lowest existing volume subway station operated by the TTC. It is noted that high density redevelopment is underway at Bessarion Station which will significantly increase station ridership in the coming years. Therefore, based on constrained redevelopment opportunities and low ridership projection, it is recommended that Royal Orchard Station not be included as part of the subway extension.

Nevertheless, based on the distance between Clark and Langstaff stations, an electrical substation and emergency exit building will still be required in the vicinity of the Royal Orchard Station location. Without a station, there are more options to locate these facilities so as to minimize impacts on existing and future land uses in the area.

LANGSTAFF STATION

The design has progressed for the alignment of the Langstaff and Richmond Hill Centre stations

As a result of further work carried out on the overall alignment, the platforms at Richmond Hill Centre and Langstaff Stations can shift up to 35 metres closer together. The shift requires deviations from the minimum TTC standards, which will require design variance approvals from the TTC. A shift of the Langstaff Station platform to the north will provide a shorter connection to the planned entrance building in the southeast quadrant of the Langstaff/Yonge intersection which will serve the future Langstaff Gateway development.

The design of the commuter parking lot has been advanced in order to provide new stormwater management ponds required as part of the stormwater management strategy for the site. Layout of the parking lot, noise attenuation measures, as well as sustainable design features will be determined as part of the next stage of design.

RICHMOND HILL CENTRE STATION

Several design options for the bus terminal at Richmond Hill Centre (RHC) have been explored

One option is a single level 25-bay bus terminal which connects the underground subway station to Langstaff GO Station via the existing pedestrian bridge. The design also protects for a future passenger connection to the 407 Transitway. The subway station, including the bus terminal, will be designed to be fully integrated into future development and the future road network planned by the Town of Richmond Hill.

However, given the complexity and importance of the relationship between TOD and transit facilities within the area, it is recognized that more design and planning work is required for the bus terminal and associated surface facilities at Richmond Hill Centre Station. The conceptual design of a single level terminal has been used for cost estimation purposes only.

Design principles for the RHC bus terminal have been established

The key principles for the Richmond Hill Centre bus terminal design are to:

- Provide a high quality, efficient passenger connection between the various modes of transit included within the anchor hub
- Provide good access to facilitate surface transit operations
- Maximize the use of lands that are already encumbered for development purposes
- Facilitate opportunities for integration with future TOD

- Allow for construction and operation independent of the status of surrounding development

Additional work is required to design the bus terminal in conjunction with TOD, to connect the fixed rapid transit elements. This work will be developed through the next stage of design in consultation with all key stakeholders.

TRAIN STORAGE FACILITY

A preferred option for the required storage facility to accommodate 14 subway trains north of Richmond Hill Centre Station has been identified

The need for this facility was identified in the TTC Subway Rail Yard Needs Study (SRYNS), which was endorsed by the YRRTC Board in May of 2010. Options which can accommodate 14 train sets were developed, reviewed, and analysed. Considerations were given to not preclude a future extension of the Yonge Subway north from Richmond Hill Centre. Three short-listed options were evaluated in terms of; a future 16th Avenue station location, property and building impacts, constructability, future extension, capital and operating costs, noise and vibration, operational issues etc. The preferred option for the train storage facility is an 831m long triple-track structure along the west side of the CN rail corridor, under the 15m wide Town of Richmond Hill property planned for future transit use. The train storage facility will require parking, a staff building, and an elevator.

The implementation of a train storage facility for the YSE will require a separate TPAP.

CONSTRUCTION METHODS

Tunnelling and cut-and-cover construction methods will be used on the YSE project

The majority of the project will be twin tunnels which will be constructed by using tunnelling construction methods. Stations, special trackwork, and emergency exit buildings will be constructed by cut-and-cover methods. Because the majority of the YSE stations, special track work, and EEBs are located within the Yonge Street right-of-way, cut-and-cover construction for these facilities will therefore require a series of measures to initially divert traffic and utilities to permit installation of the selected excavation support system.

CAPITAL COST ESTIMATE

The conceptual design study confirms the capital cost estimate of the YSE project is in the order of \$3 billion, in 2011 dollars

Based on the costing work, the early stage of design (approximately 3 to 5 percent), and the magnitude of contingency being carried, the capital cost estimate for the YSE project is estimated to be in the order of \$3 billion in 2011 dollars. This estimate reflects inflation since 2008, input from geotechnical infield investigation, evolution of the

design, as well as lessons learned from the Toronto-York Spadina Subway Extension (TYSSE). The annual impact of inflation on this project is approximately \$110 million based on an assumed 4% inflation rate per year.

FUTURE WORK AND NEXT STEPS

Preliminary comments on the draft version of this report have been received from the Town of Markham, Town of Richmond Hill, City of Vaughan, York Region, TTC and the City of Toronto. All comments, responses and action items have been included in Attachment 3.

Changes to the design for the Yonge Subway extension since the TPAP include:

- Reduction in the size of the underground bus terminal at Steeles Station;
- Removal of the bus portal on Yonge Street which accessed the underground bus terminal north of Steeles Avenue;
- Introduction of a bus loop at the Clark Station to reduce bus volumes at Steeles Station and allow the removal of the bus portal on Yonge Street;
- Removal of the Royal Orchard Station;
- Addition of the underground train storage facility north of the Richmond Hill Station.

Upon completion of the Conceptual Design Study, several issues will need to be addressed to keep the project moving forward to the next stage of design:

- Complete a TPAP for the extension of the project to include the underground train storage facility north of Richmond Hill Centre Station;
- Continue work with the Town of Richmond Hill, Town of Markham, the 407 ETR, Metrolinx, and area land owners on integration of a bus terminal with area development to connect the rapid transit infrastructure located within the Richmond Hill Centre Station and the Richmond Hill Centre / Langstaff Mobility Hub;
- Undertake a property protection study to address any property required for the YSE that is not already protected under the approved TPAP.
- Undertake the development of a preliminary engineering work program for the YSE.

YONGE SUBWAY EXTENSION CONCEPTUAL DESIGN SERVICES CONCEPTUAL DESIGN REPORT

TABLE OF CONTENTS

	Page
1. INTRODUCTION	1
1.1 Background.....	1
1.2 Current Status.....	1
1.3 Scope of Study	1
2. PASSENGER DEMAND FORECAST	2
2.1 Ridership Projection at Royal Orchard Station.....	3
3. ALIGNMENT & RUNNING STRUCTURE	5
3.1 Alignment.....	5
3.2 Stations	5
3.3 Running Structure.....	6
3.3.1 Tunnels	6
3.3.2 Box Structure	6
3.3.3 Open Cut Sections	6
3.3.4 Walkways	6
3.3.5 Drainage.....	6
3.3.6 Track Support Structure.....	7
3.3.7 Embedded Conduit	7
3.4 Emergency Exits and Cross Passages	7
4. SYSTEMS OPERATION & CONFIGURATION	8
4.1 Service Requirements.....	8
4.1.1 Run and Dwell Times.....	8
4.1.2 Fleet Size and Train Configuration	8
4.2 Track Plan	10
4.2.1 Finch Station	10
4.2.2 Steeles Station.....	10
4.2.3 Richmond Hill Centre Station	10
4.2.4 Train storage Facility.....	10
4.3 Vehicles	11
4.3.1 Revenue Trains.....	11
4.3.2 Work Trains.....	11
4.4 Traction Power	11
4.4.1 Cummer, Steeles, and Clark Substations.....	11
4.4.2 Royal Orchard Substation.....	11
4.4.3 Langstaff Station	11
4.4.4 Richmond Hill Centre Substation.....	11
4.4.5 Power Control and Traction Power Rail Circuiting	11
4.5 AC Power	12
4.6 Essential Power.....	12
4.7 Tunnel Ventilation	12
5. GEOTECHNICAL	14
5.1 Overview	14
5.2 Geotechnical Reports for Conceptual Design	14
5.3 Design Basis.....	14
5.4 Future Subsurface Explorations and Testing	14
5.5 Comparative Summary of Yonge Subway Extension Requirements	14
6. STATION DESIGN CONSIDERATIONS	17
6.1 Approach.....	17
6.2 Architectural Design Philosophy.....	17
6.3 Station Design Guidelines.....	17
6.4 Station Planning.....	17
6.4.1 Background.....	17
6.4.2 Transit Oriented Development.....	17
6.4.3 Civic Aspirations	17
6.4.4 Property Impacts.....	18
6.4.5 Fare Integration.....	18
6.4.6 Intermodal Transfer.....	18
6.4.7 Sustainability.....	18
6.4.8 Technology	18
6.5 Station Zones.....	18
6.5.1 Zone 1 – The Entrance Building	19
6.5.2 Zone 2 – The Concourse	19
6.5.3 Zone 3 – The Platform	19
6.5.4 Zone 4 – Circulation Ways.....	20
6.5.5 Zone 5 – Bus Facility	20
6.5.6 ZONE 6 – Substation (Traction Power)	20

6.6	Station Design	20	8.1	Passenger Transfer Movements	42
6.6.1	Passenger Experience	20	8.2	Bus Terminal	42
6.6.2	Way Finding	21	8.3	Station Entrances	43
6.6.3	Personal Security	21	8.4	Street Level	43
6.6.4	Building Regulations	21	8.5	Concourse Level	44
6.6.5	TTC Design Standards	21	8.6	Bus Terminal Level	44
6.6.6	Accessibility	21	8.7	Platform Level	44
6.6.7	Health and Safety	21	8.8	Roads	44
6.6.8	Ventilation	21	8.9	Passenger Pick-Up/Drop-Off	45
6.6.9	Fare Collection	21	8.10	Utilities and Relocation Strategy	45
6.6.10	Train Loading	22	8.11	Archaeological Assessment	45
6.6.11	Platform Configuration	22	9.	CLARK STATION	68
6.6.12	Elevators and Escalators	22	9.1	Passenger Transfer Movements	68
6.6.13	Finish Materials	22	9.2	Station Entrances	68
6.6.14	Station Maintenance	22	9.3	Street Level	68
6.6.15	Standard Elements	22	9.4	Concourse Level	68
6.6.16	Lighting	22	9.5	Platform Level	69
6.6.17	Signage	22	9.6	Electrical Substation	69
6.6.18	Communication Systems	22	9.7	Bus Loop	69
6.6.19	Public Toilets	22	9.8	Utilities and Relocation Strategy	69
6.7	Other Facilities	23	10.	LANGSTAFF STATION	83
6.7.1	Design Guidelines	23	10.1	Passenger Transfer Movements	83
6.8	Structural Design Consideration	23	10.2	Station Entrances	83
6.8.1	Design Basis	23	10.3	Street Level	83
6.8.2	Structural Assumptions for Yonge Subway Extension	23	10.4	Concourse Level	83
7.	CUMMER STATION	25	10.5	Platform Level	84
7.1	Passenger Transfer Movements	25	10.6	Commuter Parking and Passenger Pick-Up/Drop-Off	84
7.2	Station Entrances	25	10.7	Drainage and Stormwater Management	84
7.3	Street Level	25	10.8	Utilities and Relocation Strategy	84
7.4	Concourse Level	25	10.9	Archaeological Assessment	84
7.5	Platform Level	26	11.	RICHMOND HILL CENTRE STATION	99
7.6	Electrical Substation	26	11.1	Passenger Transfer Movements	100
7.7	Roads	26	11.2	Bus Terminal	100
7.8	Bus Loop	26	11.3	Station Entrances	103
7.9	Utilities and Relocation Strategy	26	11.4	Street Level	103
8.	STEELES STATION	42	11.5	Concourse Level	103

11.6	Platform Level.....	103	14.2.1	Traditional or Conventional Procurement – Design-Bid-Build.....	118
11.7	Roads.....	104	14.2.2	Design-Build (D-B).....	118
11.8	Passenger Pick-Up/Drop-Off.....	104	14.2.3	Design, Build and Finance (DBF).....	118
11.9	Utilities and Relocation Strategy.....	104	14.2.4	Design, Build, Finance and Maintain (DBFM); Design, Build, Finance, Operate and Maintain (DBFOM) 118	
12.	EAST DON RIVER BRIDGE.....	106	14.3	Construction Staging/Methodology.....	119
12.1	Alternatives Considered.....	106	14.3.1	Launch Shafts.....	119
12.1.1	Span Arrangements.....	106	14.3.2	Tunnel Boring Machines.....	119
12.1.2	Superstructures.....	106	14.3.3	Tunnel Drives.....	119
12.1.2.1	Steel Plate Girder.....	106	14.3.4	Tunnel Segmental Lining.....	119
12.1.2.2	Pre-Stressed Concrete Girder.....	107	14.3.5	Extraction Shafts.....	119
12.1.2.3	Steel Truss.....	107	14.3.6	Cut and Cover Construction.....	120
12.1.2.4	Tubular Steel Arch.....	107	14.4	Construction Sites.....	120
12.1.2.5	Steel Through Arch.....	107	14.4.1	Richmond Hill Centre Station and Vicinity.....	120
12.1.2.6	Post Tensioned Box.....	107	14.4.2	East Don River Bridge and Vicinity.....	121
12.1.3	Bridge Deck.....	108	14.4.3	Steeles Station and Vicinity.....	121
12.2	Substructure and Foundations.....	108	14.4.4	Cummer Station and Vicinity.....	122
12.3	Bridge Aesthetics.....	108	14.5	Traffic Management.....	122
12.4	Structural Design.....	108	14.5.1	Traffic Lanes.....	122
12.4.1	Footings.....	108	14.5.2	Alternative Traffic Options.....	123
12.4.2	Abutment and Pier.....	108	14.5.3	Road Closures.....	123
12.4.3	Superstructure.....	108	14.5.4	Turn Lanes.....	123
12.5	Bridge Finishes.....	108	14.5.5	Signing.....	123
12.6	Navigational Requirements.....	109	14.5.6	Traffic Signal Adjustments/Timing.....	123
12.7	Bridge Construction.....	109	14.5.7	Transit Operations and HOV Lanes.....	123
12.7.1	Plate Girder Option.....	109	14.5.8	Pedestrians.....	123
12.7.2	Steel Through Arch Option.....	109	14.5.9	Private Access.....	123
12.7.3	Construction Staging.....	109	14.6	Construction Schedule.....	123
12.8	Construction Schedule.....	109	14.7	Critical Path.....	123
13.	TRAIN STORAGE AND MAINTENANCE FACILITY.....	112	15.	PROPERTY REQUIREMENTS.....	127
13.1	Planning Requirements and Design Considerations.....	112	16.	CAPITAL COST ESTIMATE.....	128
13.2	Alignment and Configuration.....	112	17.	FUTURE WORK AND NEXT STEPS.....	129
13.3	Operational Requirements.....	112			
13.4	Facility Requirements.....	113			
14.	CONSTRUCTION PLAN.....	118			
14.1	Purpose and Scope.....	118			
14.2	Project Delivery Options.....	118			

ATTACHMENTS

- Attachment 1 Proposed Yonge Subway Extension Construction Schedule
- Attachment 2 Proposed Yonge Subway Extension Project Schedule
- Attachment 3 Comments Received on Draft Conceptual Design Report

APPENDICES

- Appendix 'A' Passenger Demand Forecast
- Appendix 'B' System Configuration Report
- Appendix 'C' Traction Power Configuration Report
- Appendix 'D' Tunnel Incident Ventilation Analysis Report
- Appendix 'E' Station Peak Hour Patronage Data
- Appendix 'F' Stage 2 Archaeological Assessment
- Appendix 'G' Preliminary Drainage and SWM for the Commuter Parking Lot at Langstaff Subway Station
- Appendix 'H' Detailed Acoustic Assessment for the Proposed Commuter Parking Lot at Langstaff Subway Station
- Appendix 'I' Detailed Acoustic Assessment for the East Don River Bridge
- Appendix 'J' Construction Plan Report
- Appendix 'K' Permanent Property Requirements (Preliminary)

LIST OF TABLES

	Page
Table 2-1: Yonge Subway Extension Forecast Station Activity	2
Table 2-2: Projected Northbound-Southbound Subway Passenger Volume Split.....	3
Table 3-1: List of Horizontal Curves.....	5
Table 3-2: List of Vertical Curves.....	5
Table 3-3: Station to Station Distances.....	5
Table 4-1: Estimated Round-Trip Time between Finch Station and Richmond Hill Centre Station	9
Table 5-1: Preliminary Comparison of Soil and Groundwater Control Conditions.....	15
Table 7-1: Estimated Passenger Transfer Movements at Cummer Station (2031).....	25
Table 8-1: Estimated Passenger Transfer Movements at Steeles Station (2031).....	42
Table 8-2: Proposed YRT Bus Bay Allocation at Steeles Station.....	42
Table 8-3: Proposed TTC Bus Bay Allocation at Steeles Station.....	43
Table 9-1: Estimated Passenger Transfer Movements at Clark Station (2031).....	68
Table 9-2: Proposed YRT Bus Bay Allocation at Clark Station.....	69
Table 10-1: Estimated Passenger Transfer Movements at Langstaff Station (2031).....	83
Table 11-1: Estimated Passenger Transfer Movements at Richmond Hill Centre Station (2031)	100
Table 11-2: Proposed YRT/Viva Bus Bay Allocation at Richmond Hill Centre Station.....	100
Table 11-3: Proposed GO Bus Bay Allocation at Richmond Hill Centre Station	101
Table 12-1: Technical Comparison of Bridge Alternatives.....	106
Table 13-1: Technical Comparison of Train Storage Facility Alignment Alternatives.....	113
Table 14-1: Minimum Number of Lanes to be Maintained.....	122
Table 16-1: YSE Conceptual Design Capital Cost Estimate (Summary)	128

LIST OF FIGURES

	Page
Figure 2-1: Royal Orchard Station	3
Figure 3-1: Cross-Section of a Bored Tunnel	6
Figure 3-2: Cross-Section of a Box Structure	6
Figure 4-1: Yonge Subway Extension Track Schematic	10
Figure 4-2: Finch Station Special Trackwork	10
Figure 4-3: Steeles Station Crossover	10
Figure 4-4: Richmond Hill Centre Station Special Trackwork.....	10
Figure 4-5: Train Storage Facility Track Schematic.....	10
Figure 4-6: Yonge Subway Extension High Voltage Power Supplies	11
Figure 4-7: Typical Traction Power Rail Feeds.....	12
Figure 4-8: Tunnel Ventilation Operation.....	13
Figure 6-1: Prototypical Plan and Spatial Configuration - Concourse Level	19
Figure 6-2: Prototypical Plan and Spatial Configuration - Platform Level	20
Figure 6-3: Typical Cross Section of Station Structure with Centre Column.....	24
Figure 11-1: Richmond Hill Centre Station 2 Level Bus Terminal Option 1 (Lower Level)	101
Figure 11-2: Richmond Hill Centre Station 2 Level Bus Terminal Option 1 (Upper Level).....	101
Figure 11-3: Richmond Hill Centre Station Bus Terminal Option 2 (Single Level).....	102
Figure 11-4: Richmond Hill Centre Station Bus Terminal Option 3 (Single Level).....	102
Figure 11-5: Richmond Hill Centre Station Bus Terminal Option 4 (Single Level)	102
Figure 13-1: Proposed Train Storage Facility (Alignment Bi, Plan View)	115
Figure 13-2: Proposed Train Storage Facility (Alignment Bi, Typical Cross Section)	116
Figure 13-3: Electrical Service Building & Maintenance Operator’s Facility (Site Plan).....	117
Figure 14-1: Proposed Tunnelling General Arrangement (Finch Station to North of the East Don River Bridge)	125
Figure 14-2: Proposed Tunnelling General Arrangement (North of the East Don River Bridge to RHC Station)	126

LIST OF DRAWINGS

Alignment and Running Structures

G3001	Yonge Subway Extension – Site Plan
Sheet 1	Track Alignment – Plan and Profile – Sta. 0+500 to Sta. 1+200
Sheet 2	Track Alignment – Plan and Profile – Sta. 1+200 to Sta. 1+900
Sheet 3	Track Alignment – Plan and Profile – Sta. 1+900 to Sta. 2+500
Sheet 4	Track Alignment – Plan and Profile – Sta. 2+500 to Sta. 3+200
Sheet 5	Track Alignment – Plan and Profile – Sta. 3+200 to Sta. 3+900
Sheet 6	Track Alignment – Plan and Profile – Sta. 3+900 to Sta. 4+600
Sheet 7	Track Alignment – Plan and Profile – Sta. 4+600 to Sta. 5+300
Sheet 8	Track Alignment – Plan and Profile – Sta. 5+300 to Sta. 6+000
Sheet 9	Track Alignment – Plan and Profile – Sta. 6+000 to Sta. 6+700
Sheet 10	Track Alignment – Plan and Profile – Sta. 6+700 to Sta. 7+300
Sheet 11	Track Alignment – Plan and Profile – Sta. 7+300 to Sta. 8+000
Sheet 12	Track Alignment – Plan and Profile – Sta. 8+000 to Sta. 8+700
Sheet 13	Track Alignment – Plan and Profile – Sta. 8+700 to Sta. 9+480
HMM-SK-043	Electrical Service Building- Maintenance Operator Facility- Plan
HMM-SK-055	Emergency Exit Building no. 1 – Site Plan
HMM-SK-056	Emergency Exit Building no. 1 – Section
HMM-SK-057	Emergency Exit Building no. 2 – Site Plan
HMM-SK-058	Emergency Exit Building no. 2 – Section
HMM-SK-059	Emergency Exit Building no. 2 – Site Plan (Option 1)
HMM-SK-060	Emergency Exit Building no. 2 – Section (option 1)
HMM-SK-061	Emergency Exit Building no. 3 – Site Plan
HMM-SK-062	Emergency Exit Building no. 3 – Section
HMM-SK-063	Emergency Exit Building no. 4 – Site Plan
HMM-SK-064	Emergency Exit Building no. 4 – Section
HMM-SK-067	Emergency Exit Building no. 5 – Site Plan
HMM-SK-068	Emergency Exit Building no. 5 – Section
HMM-SK-069	Emergency Exit Building no. 5 – Site Plan (Option 1)
HMM-SK-070	Emergency Exit Building no. 5 – Section (Option 1)
HMM-SK-071	Emergency Exit Building no. 6 – Site Plan
HMM-SK-072	Emergency Exit Building no. 6 – Section
HMM-SK-073	Emergency Exit Building no. 7 – Site Plan
HMM-SK-074	Emergency Exit Building no. 7 – Section
HMM-SK-075	Emergency Exit Building no. 8 – Section

Cummer Station

SK-A-007H	Cummer Station Street Level - Centre Platform
SK-A-008H	Cummer Station Concourse Level - Centre Platform
SK-A-009H	Cummer Station Platform Level - Centre Platform
SK-A-010H	Cummer Station Overall Cross Sections
SK-A-012H	Cummer Station Part Cross Sections Section A-A South End
SK-A-013H	Cummer Station Part Cross Sections Section A-A Centre
SK-A-014H	Cummer Station Part Cross Sections Section A-A North End
SK-A-015H	Cummer Station Part Cross Sections Section B-B
SK-A-016H	Cummer Station Part Cross Sections Section C-C
SK-A-017H	Cummer Station Part Cross Sections Section D-D
SK-A-018H	Cummer Station Part Cross Sections Section E-E
SK-A-019H	Cummer Station Street Level - Entrances

Steeles Station

SK-A-006D	Steeles Station Street Level
SK-A-007D	Steeles Station Concourse Level
SK-A-008D	Steeles Station Bus Platform Level
SK-A-009D	Steeles Station Street Level West End
SK-A-010D	Steeles Station Street Level East End
SK-A-011D	Steeles Station Platform Level
SK-A-012D	Steeles Station Overall Cross Sections Section A-A to Section D-D
SK-A-013D	Steeles Station Overall Cross Sections Option E Section E-E to Section J-J
SK-A-014D	Steeles Station Part Cross Sections Section A-A West End
SK-A-015D	Steeles Station Part Cross Sections Section A-A Centre
SK-A-016D	Steeles Station Part Cross Sections Section A-A East End
SK-A-017D	Steeles Station Part Cross Sections Section B-B South End
SK-A-018D	Steeles Station Part Cross Sections Section B-B North End
SK-A-019D	Steeles Station Part Cross Sections Section C-C
SK-A-020D	Steeles Station Part Cross Sections Section D-D
SK-A-021D	Steeles Station Part Cross Sections Section E-E
SK-A-022D	Steeles Station Part Cross Sections Section F-F
SK-A-023D	Steeles Station Part Cross Sections Section G-G
SK-A-024D	Steeles Station Part Cross Sections Section H-H
SK-A-025D	Steeles Station Part Cross Sections Section J-J
SK-A-026D	Steeles Station Street Level - Entrances 'A' Plan to 'B' Plan
SK-A-027D	Steeles Station Street Level - Entrances 'C' Plan

Clark Station

SK-A-007J	Clark Station Street Level
SK-A-008J	Clark Station Concourse Level
SK-A-009J	Clark Station Platform Level
SK-A-010J	Clark Station Overall Cross Sections
SK-A-012J	Clark Station Part Cross Sections Section A-A South End
SK-A-013J	Clark Station Part Cross Sections Section A-A Centre
SK-A-014J	Clark Station Part Cross Sections Section A-A North End
SK-A-015J	Clark Station Part Cross Sections Section B-B
SK-A-016J	Clark Station Part Cross Sections Section C-C
SK-A-017J	Clark Station Part Cross Sections Section D-D
SK-A-018J	Clark Station Part Cross Sections Section E-E
SK-A-019J	Clark Station Street Level - Entrances
SK-A-020J	Clark Station Street Level - Entrances

Royal Orchard

SK-A-007	Royal Orchard Street Level Proposed Substation
SK-A-007A	Royal Orchard Street Level Proposed EEB Options

Langstaff Station

SK-A-001E	Langstaff Station Location Plan
SK-A-002E	Langstaff Station Site Plan
SK-A-007E	Langstaff Station Street Level
SK-A-008E	Langstaff Station Concourse Level
SK-A-009E	Langstaff Station Platform Level
SK-A-010E	Langstaff Station Overall Cross Sections
SK-A-012E	Langstaff Station Part Cross Sections Section A-A South End
SK-A-013E	Langstaff Station Part Cross Sections Section A-A Centre
SK-A-014E	Langstaff Station Part Cross Sections Section A-A North End
SK-A-015E	Langstaff Station Part Cross Sections Section B-B
SK-A-016E	Langstaff Station Part Cross Sections Section C-C
SK-A-017E	Langstaff Station Part Cross Sections Section D-D
SK-A-018E	Langstaff Station Part Cross Sections Section E-E
SK-A-019E	Langstaff Station Street Level – Entrances

Richmond Hill Centre Station

SK-A-001A	Richmond Hill Centre Station Location Plan
-----------	--

Construction

HMM-SK-016	Richmond Hill Launch Shaft - Preliminary Proposed Road Diversion and Modification of Stormwater Retention Pond
HMM-SK-017	Richmond Hill Launch Shaft - Preliminary Proposed Road Diversion and Modification of Stormwater Retention Pond - Cross-sections – Sheet 1 of 2
HMM-SK-018	Richmond Hill Launch Shaft - Preliminary Proposed Road Diversion and Modification of Stormwater Retention Pond – Cross-sections – Sheet 2 of 2
HMM-SK-020	Richmond Hill Centre - Site Areas and Access
HMM-SK-021	Steeles Station and Bus Terminal – Site Areas and Access
HMM-SK-022	East Don River Bridge – Site Requirements
HMM-SK-023	Tunnel- General Arrangement –Sh.1 of 2
HMM-SK-024	Tunnel- General Arrangement –Sh.2 of 2
HMM-SK-025	Finch Station Tail Track Extension & Cummer Station – Site Areas and Access
HMM-SK-031	Steeles Station – Traffic Diversion Scheme – Stage 1
HMM-SK-032	Steeles Station – Traffic Diversion Scheme – Stage 2
HMM-SK-033	Steeles Station – Traffic Diversion Scheme – Stage 3
HMM-SK-036	East Don River Bridge – Traffic Diversion – Stage 1
HMM-SK-037	East Don River Bridge – Traffic Diversion – Stage 2
HMM-SK-039	East Don River Bridge – Traffic Diversion – Stage 2 – Sta. 4+900
HMM-SK-040	East Don River Bridge – Traffic Diversion – Stage 2 – Sta. 5+230

GLOSSARY OF TERMS

Abbreviation	Term
CPTED	Crime Prevention Through Environmental Design
EPR	Environmental Project Report
GTA	Greater Toronto Area
PDE	Planning, Design, and Engineering
RTP	Regional Transportation Plan
RYNS	Rail Yards Needs Study
TOD	Transit Oriented Development
TTC	Toronto Transit Commission
TPAP	Transit Project Assessment Process
TYSSE	Toronto York Spadina Subway Extension
VTHCD	Vaughan Thornhill Heritage Conservation District
YRRTC	York Region Rapid Transit Consortium
YSE	Yonge Subway Extension

1. INTRODUCTION

In October 2009, the City of Toronto and the Regional Municipality of York authorized the Toronto Transit Commission (TTC) and York Region Rapid Transit Corporation (YRRTC) to proceed with the Conceptual Design Study for the Yonge Subway Extension (YSE). The Joint Venture of McCormick Rankin Corporation and Hatch Mott MacDonald was retained by the TTC and YRRTC to carry out the work. The purpose of the study is to undertake the additional analysis resulting from the July 2009 Metrolinx Benefits Cost Analysis (BCA) of the YSE project, including an update of the projected ridership and estimated capital costs. The Conceptual Design Study also continues to advance the design of the YSE project to maintain a state of readiness for implementation.

1.1 Background

On June 15, 2007, the Province of Ontario announced \$17.5 billion in funding for transit projects for the Greater Toronto Area and Hamilton. Named “MoveOntario 2020”, the provincial transit plan includes an extension of the Yonge Subway from its current terminus at Finch Station in the City of Toronto to Highway 7 (Richmond Hill Centre) in the Town of Richmond Hill.

On June 21, 2007, York Region Council authorized commencement of a Functional Planning Study in coordination with the TTC and the City of Toronto for the extension of the subway. The scope of work included an examination and evaluation of possible subway alignment alternatives, station locations, and surface facilities associated with each station along the corridor. The goal was to develop a technically feasible and preferred solution in consultation with public and government stakeholders.

On October 3, 2008, following completion of a Functional Planning Study, York Region initiated the Transit Project Assessment Process (TPAP) for the YSE to Richmond Hill Centre (the Transit Project). Results from the Functional Planning Study served as the basis that defined the Transit Project. At the end of October 2008, Toronto City Council authorized the TTC and the City of Toronto as co-proponents of the Transit Project.

Final approval of the YSE TPAP submission was received from the Ontario Minister of the Environment on April 7, 2009. The approval did not state any conditions that would affect the design and construction of the project over and above the mitigative measures outlined in the EPR.

1.2 Current Status

While the TPAP for the project has been approved, a full funding commitment to the project has not been received. In the interim period between the completion of the TPAP and a full funding commitment to the project, the TTC, in partnership with YRRTC, is proceeding with planning, design and engineering (PDE) activities in accordance with the February 20, 2009 Metrolinx staff report to the Metrolinx Board. The Metrolinx staff report provided the following definition of PDE costs:

“A combination of project planning, specification and assessment costs, including environmental, surveying, engineering, architectural supervision and management consulting services.”

The quality and reliability of the project data generated during the PDE process will be critical to the fiscal planning responsibilities and cost management objectives of all potential funding partners.

PDE is essentially an enhanced definition of preliminary engineering, in order to produce a solid project definition based on reliable estimate of costs, benefits, impacts and risks. Engineering and design should ultimately and conclusively result in the development of a specific project with definitive scope elements, alignment, and design features such that the project cost and implementation schedule are known with enough certainty to:

- Provide a reasonable assurance that the project will continue to meet the objectives of the Metrolinx Regional Transportation Plan (RTP) through to the final design and construction phases; and
- Identify, with confidence, the amount of funding required to complete the project.

1.3 Scope of Study

The scope of the YSE Conceptual Design Study is summarized as follows:

- Confirmation of the location of station platforms
- Confirmation of the preferred location of surface facilities for stations/tunnels
- Conceptual design of stations/tunnels/East Don River Bridge
- Confirmation of the final horizontal/vertical alignment of the project
- The development of a construction logistics plan for the project
- Preliminary contract packaging
- Preliminary protection/definition of property requirements
- The development of the necessary topographic survey and geotechnical investigations to allow preliminary and detailed design to proceed
- The development of key principles to guide project implementation
- The development of capital cost estimates

2. PASSENGER DEMAND FORECAST

A passenger demand forecast was carried out by the City of Toronto and the Toronto Transit Commission to support the Consultant Team's conceptual design effort. The intent of the analysis was to develop a set of estimated passenger transfer activities at a sufficient level of detail to help inform the design of each station. The analysis also provides a picture of the transit passenger trips that are expected to use the Yonge Subway Extension when the new facility is in place.

The original source of ridership forecasts is the 2008/2009 Toronto/TTC modelling work done in conjunction with the Yonge Subway Extension Transit Project Assessment. These forecasts were updated in 2010 to include updated 2031 York Region and City of Toronto land use forecasts, updated TTC and YRT local transit networks, and regional transit infrastructure projects. Details on the demand forecast analysis can be found in **Appendix 'A'** of this report.

The analysis followed the current forecasting process adopted by the City of Toronto and the TTC. This process involves the following steps:

- Updating future land use projections in the study area, particularly in York Region
- Coding the Yonge Subway Extension in the City of Toronto GTA and the TTC MADITUC models
- Coding any changes in the feeder bus network, particularly in the City of Toronto and York Region
- Running the City of Toronto's GTA Model to produce transit demand matrices
- Running the TTC's MADITUC Model using the derived transit demand matrices from the GTA model
- Generating statistics and interpreting the results

The Year 2031 was chosen as the planning horizon based on the projected population and employment growths available from York Region and the City of Toronto. This approach is consistent with the expectation that the demand projected for the subway extension will not be achieved overnight when the facility is opened, but will grow over a period of a few years.

The models are coded to represent AM peak period transit network, and ridership forecasts are produced for the AM peak hour for the year 2031.

The modelling work undertaken represented a consolidation and reconciliation of recent land use planning initiatives along the Yonge Street corridor (Markham, Vaughan, Richmond Hill), as well as the planned transit infrastructure projects adopted by Metrolinx/GO Transit. The forecasts reflect the potential future growth within the corridor and the interchange between different transport modes at each station. The forecasts will inform the dimensional characteristics of the station entrances, escalators, circulation routes and emergency egress requirements. It is assumed the train service will be 3'30" headways or approximately 17 trains per hour north of Finch and south of Finch 1'45" headways or 34 trains per hour during the AM/PM peak periods.

Results from the demand forecast analysis can be found in **Table 2-1**.

Note that the City of Toronto is initiating a review of the area to the south of Steeles Avenue which will likely result in increased density and therefore more walk-in ridership potential.

Table 2-1: Yonge Subway Extension Forecast Station Activity

2031 AM Peak Hour Southbound Subway Boardings, Alightings and Link Volumes

Station Name	Southbound				Link Volume Departing Station	Park and Ride Total Persons	Scenario – existing (2006) TTC trips assigned to subway extension		
	Boarding		Alighting				Link Volume Departing Station	Park and Ride Total Persons	Link Volume Departing Station
	Initial	Transfer	Initial	Transfer					
Richmond Hill Centre	580	12720	0	0	13300		4510		
Langstaff (Longbridge)	1970	0	10	0	15260	1590	5940		
Royal Orchard	160	30	60	0	15390		5940		
Clark	310	330	90	0	15940		6380		
Steeles	270	2930	30	220	18890		8910		
Cummer	450	870	50	30	20130		10120		
Finch	2340	3060	210	620	24700	1050	15180		
Total	6080	19940	450	870		2640			

2031 AM Peak Hour Northbound Subway Boardings, Alightings and Link Volumes

Station Name	Northbound				Link Volume Departing Station	Park and Ride Total Persons	Scenario – existing (2006) TTC trips assigned to subway extension		
	Boarding		Alighting				Link Volume Departing Station	Park and Ride Total Persons	Existing 2006 Transit Users*
	Initial	Transfer	Initial	Transfer					
Richmond Hill Centre	0	0	60	730	0		0		
Langstaff (Longbridge)	80	0	200	0	790	0	400		
Royal Orchard	30	40	20	0	910		500		
Clark	90	10	40	0	860		500		
Steeles	20	80	300	1150	800		500		
Cummer	100	40	400	130	2150		1300		
Finch	160	250	710	1130	2540	0	1500		
Total	480	420	1730	3140		0			

Includes a 10% increase to account for differences between MADITUC and the GTA Model.

*Existing riders are estimated by assigning the 2006 Transportation Tomorrow Survey demand to the 2031 YSE network. Adjustments were made for 2650 southbound auto access trips to Finch Station in 2006 that would likely drive to RHC or Langstaff.

As shown in Table 2-1, the MADITUC Model projects approximately 13,300 passengers boarding the subway at Richmond Hill Centre Station and travelling southbound during the morning peak hour in 2031. The southbound link volume increases to approximately 16,000 passengers approaching Steeles Station and close to 25,000 passenger leaving Finch Station. In comparison, current morning peak hour passenger volume southbound past Finch Station is just under 10,200¹. With respect to the counter-peak direction, the model projects approximately 2,540 passengers travelling northbound on the subway past Finch Station during the morning peak hour in 2031. This demand decreases to approximately 800 passengers past Steeles Station. By comparison, the ridership projections during the TPAP for Yonge Subway were 15,000-17,000 passengers south at Steeles, current projections identify 18,890 passengers. **Table 2-2** illustrates the northbound-southbound volume split projected by the MADITUC model:

Table 2-2: Projected Northbound-Southbound Subway Passenger Volume Split

Link	Southbound Volume	Northbound Volume	Total Volume Passing Through Station
Richmond Hill Centre-Langstaff	13,300	790	14,090
Langstaff-Royal Orchard	15,260	910	16,170
Royal Orchard-Clark	15,390	860	16,250
Clark-Steeles	15,940	800	16,740
Steeles-Cummer	18,890	2,150	21,040
Cummer-Finch	20,130	2,540	22,670

Using Steeles Station as a screen line, results from the model indicate that approximately 95% of the total subway passengers in York Region would travel in the southbound direction during the morning *peak hour*, while the remaining 5% would travel northbound. However, this projection contradicts the Year 2009 transit rider cordon counts conducted by York Region which indicate that, of all current transit riders travelling in the Yonge Street corridor (YRT, Viva, GO Bus) during the morning *peak period*, approximately 58% (3,122 passengers) travelled in the southbound direction while 42% (2,250 passengers) travelled northbound. Therefore, the York Region 2009 transit rider cordon counts suggest that there may be a larger reverse commute in the counter-peak direction than suggested by the MADITUC model.

Results from the MADITUC model also suggest that passenger demand at Langstaff Station is predominantly driven by the commuter parking lot located at this station. Of the 2,260 passengers projected to board and alight at Langstaff Station during the morning peak hour, approximately 1,590 (or 70%) are attributed to the commuter parking lot while the remaining 30% are considered walk-in/walk-out traffic generated by the surrounding neighbourhood. Both the proportion of walk-in/walk-out riders and the overall ridership projection at Langstaff Station are less than anticipated, given the level of land use intensification planned by the Town of Markham at the Langstaff Gateway development site. This is likely due to the fact that the majority of the development site is beyond the 500m radius station catchment area. Sensitivity tests which included the inclusion of frequent transit services which providing feeder connections to the subway station did not significantly increase the projected passenger volumes.

2.1 Ridership Projection at Royal Orchard Station

As shown in Table 2-1, the MADITUC model projected 340 passengers boarding and alighting at Royal Orchard Station during the morning peak hour in 2031, making it the least busy of the six proposed stations on the YSE. In comparison, current morning peak hour ridership at Bessarion Station – the least used station on the entire TTC subway system – is approximately 540. The low existing ridership is attributed to the limited existing population and employment; however, significant redevelopment and intensification is underway. Construction is already underway for high density development which will significantly increase ridership at Bessarion Station.

Figure 2-1: Royal Orchard Station



Approximately 55% of the developable land located within 500m of the proposed Royal Orchard station is situated within the Vaughan Thornhill Heritage Conservation District (VTHCD), see Figure 2-1. The VTHCD reflects the strong heritage aspects of the area and significantly limits redevelopment and intensification opportunities. In addition, the relatively shallow lots on the Vaughan side with the well-established Uplands community behind it and the existing high density on the Markham side, further limit the redevelopment opportunities surrounding the Royal Orchard station. Within the 500m surrounding the proposed station, approximately 70% of the 2031 projected development is already present.

¹ TTC 2009 Station Platform Usage Counts: Subway and Scarborough RT Systems

Limited redevelopment and intensification opportunities in conjunction with a challenging existing property fabric significantly reduce the projected ridership volumes for Royal Orchard station. The projected ridership volumes are too low to justify the capital and operating expenses associated with a subway station. Population and employment densities need to be comparable to the areas around the North York Centre station (Yonge line) or the Bayview station (Sheppard line) in order to justify a subway station. This is not the vision for the area surrounding the proposed Royal Orchard Station. Based on these constraints, it is recommended that Royal Orchard Station not be included as part of the subway extension. The area will still be served by transit with YRT bus service providing area residents with connections to Langstaff Station to the north and Clark Station to the south.

3. ALIGNMENT & RUNNING STRUCTURE

3.1 Alignment

The alignment of the YSE is based on the TTC Design Manual criteria for subway technology. The running structure cross-section is based on the “T” and “Toronto Rocket” series subway vehicle dimensions and dynamic clearances. The alignment is primarily underground with the exception of the East Don River Bridge Crossing where the alignment projects above the surrounding grade in the valley. It has been assumed that the bridge will be enclosed to maintain the integrity of the tunnel ventilation system and mitigate against noise transfer to the surrounding community.

Between the extension of the existing Finch Station tail track and Langstaff Station, the alignment runs north below Yonge Street. North of Langstaff Station two reverse curves are provided to divert the alignment from Yonge Street to the preferred location for Richmond Hill Centre Station located approximately 240m from the centreline of Yonge Street. An 834m long triple track train storage facility is provided north of the Richmond Hill Station on west side of the CN Bala/Richmond Hill GO Line. Crossovers, which allow trains to switch between the northbound and southbound tracks, are provided south of Steeles Station and south of Richmond Hill Centre Station. The alignment passes below the following major roads and rail line: Steeles Avenue, Canadian National Railway corridor, Clark Avenue, Centre Street -Thornhill Summit Way, Highway 407, Highway 7, Hydro One’s 230/500 kV transmission facilities; and as noted above, the alignment passes over the East Don River.

The horizontal curves along the alignment from the existing Finch Station to Richmond Hill Centre Station are summarized in **Table 3-1**:

Table 3-1: List of Horizontal Curves

ID	Radius (m)	Curve	Length (m)*	Location
1	5000	Left hand	89	North of Steeles Station
2	5000	Right hand	134.6	South of Clark Station
3	5000	Right hand	88.3	At chainage 4+500
4	5000	Right hand	88.3	South of the East Don River Bridge
5	5000	Right hand	106.2	North of the East Don River Bridge
6	1000	Right hand	85.2	South of Langstaff Station
7	467	Right hand	351.4	North of Langstaff Station
8	467	Left hand	392.7	South of the Richmond Hill Centre Station crossover
9	1500	Right hand	107	North of Richmond Hill Centre Station in the train storage facility

*Including spiral lengths

The vertical curves along the alignment from the existing Finch Station to Richmond Hill Centre Station are summarized in **Table 3-2**:

Table 3-2: List of Vertical Curves

ID	Description
1	From an elevation of 181.33 at chainage 1+000 (north end of the existing Finch Station tail track), the vertical alignment drops at -2.932% prior to transitioning to a -0.30 % through Cummer Station to an elevation low of 172.78 immediately north of Cummer Station
2	The alignment climbs at +0.30% past EEB#1 to a high point of elevation 175.00 just south of the Steeles Station crossover
3	The alignment descends at -0.30% through Steeles Station and crossover where it changes to -2.47% past EEB #2 and then transitions to -0.30% through Clark Station reaching the alignment low point of elevation 155.92 at EEB#3 at chainage 4+160
4	The alignment climbs at +1.08% across the East Don River Bridge changing to +0.30% to an elevation of 168.13 at chainage 5+594, just past EEB#5
5	The alignment then climbs at +1.44% to elevation 175.01 south of Langstaff Station prior to transitioning to +0.30% through Langstaff Station and then rising at +1.77% to elevation 183.37 just past EEB#6
6	The alignment then climbs at +0.30% through the Richmond Hill Centre Station and crossover and continues at that gradient throughout the train storage facility (discussed in further detail in Section 13) terminating at elevation 187.13 at chainage 8+418

Distance along the alignment, also called stationing or chainage, is measured in metres and increases in a northerly direction. The Yonge Subway Extension (YSE) starts at chainage 1+000 at the north end of the existing Finch Station tail track and ends at chainage 8+418 at the north end of the train storage facility (discussed in further detail in **Section 13**).

3.2 Stations

All passenger stations planned for the YSE will have a centre platform configuration where passengers will board and exit trains via a single platform located between two subway tracks. Generally, access to platforms from street level will be via a concourse level located between the street level and the subway platform level. Passenger stations will be fully accessible to persons with disabilities.

Platform lengths will be established based on subway technology assuming a revenue train length as defined in Section 4.3.1. To allow for possible train length extensions to 7-car long trainsets, the standard platform lengths of 152.4m (500') will be maintained for the YSE platforms. Platform widths will typically be 10.3m based on the tunnel track centre-lines. Narrower platforms could be considered for line stations where platform columns were eliminated. Station to station distances for the YSE commencing at Finch Station are summarized in **Table 3-3**.

Table 3-3: Station to Station Distances

From (Centre of Platform)	To (Centre of Platform)	Distance (m)
Finch	Cummer	753
Cummer	Steeles	1210
Steeles	Clark	1068
Clark	Langstaff	2673
Langstaff	Richmond Hill Centre	1120

Ancillary facilities, interchange with GO Transit services, off street bus terminals, and passenger pick up/drop off and commuter parking for passengers, will be provided as required at stations in order to facilitate passenger access to the subway. The specific facilities for each station are described in Sections 7 through 11.

3.3 Running Structure

This section summarizes running structure and access provisions including emergency access points and walkways. It includes descriptions of typical cross-sections for bored tunnel and box section running structure. For complete details on these requirements, refer to the TTC Design Manual.

3.3.1 TUNNELS

The Yonge Subway Extension will be constructed with an internal tunnel diameter of 5.4m. This diameter is consistent with that of the current TYSSE Project but slightly larger than the diameter of the Sheppard Twin Tunnels due to Code changes related to the dimensions of the safety envelope above the safety walkway. A typical cross-section for a tunnel is shown on **Figure 3-1**.

Figure 3-1: Cross-Section of a Bored Tunnel

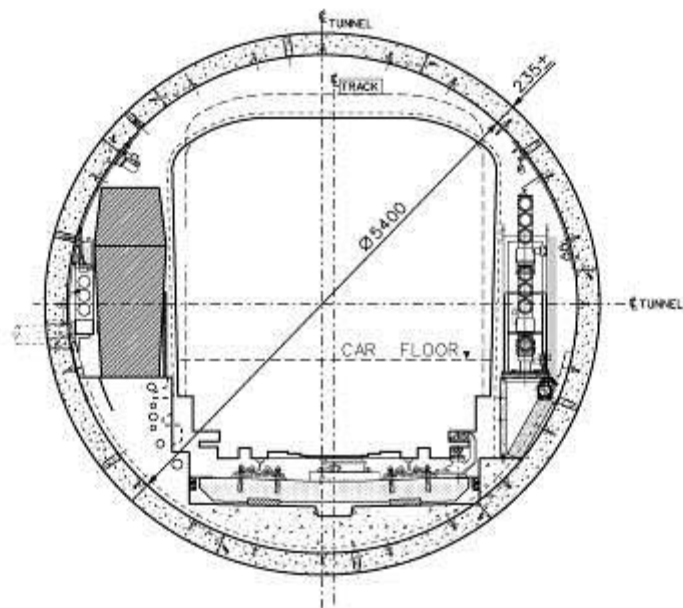

3.3.2 BOX STRUCTURE

A typical cross-section for a box structure is illustrated on **Figure 3-2**.

Figure 3-2: Cross-Section of a Box Structure

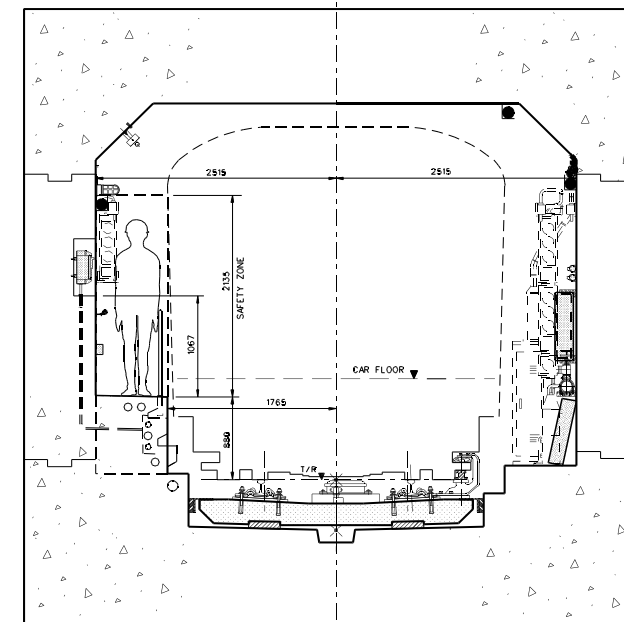

3.3.3 OPEN CUT SECTIONS

There will be no open track on the Yonge Subway Extension. A bridge structure is provided for the East Don River crossing which does result in the alignment actually being above the surrounding grade. To maintain the integrity of the ventilation system, limit vehicle noise transmission and to mitigate any water entering into the system, the bridge structure is currently designed to be fully enclosed.

3.3.4 WALKWAYS

A walkway system consisting of a safety walkway and a service-way will be provided between stations. The safety walkway will support the emergency evacuation of a train in a tunnel and provide an access path to track-way installed equipment for maintenance personnel. The service-way will be used in box tunnel structures for equipment installations. The walkway should be provided throughout the entire extension, the design should not create any zero-clearance areas for workers at track level.

The safety walkway will be elevated (approximately one step below vehicle floor height) and the service-way will be near track level. This design allows for a continuous route for the embedment of conduit for the protection of life safety critical systems/services.

The safety walkway is located on the left of the track-ways for operations in the normal direction of travel. This provides direct connection to the center platform stations. Emergency Exit Building track-way access is also centred between the northbound and southbound tunnels.

3.3.5 DRAINAGE

The entire line will exhibit a longitudinal gradient of at least 0.3% to ensure adequate run-off, via the standard drainage provisions (see TTC Design Manual).

Pumping stations will be provided at the low points on the alignment as follows:

- At Cummer Station (low point immediately north of the station), and
- At EEB #3, north of Clark Station (low point on the entire alignment extension).

Pumping stations will also be located at special trackwork locations (junction of floating slab and double ties). These locations include:

- At the southerly end of Steeles and Richmond Hill crossovers;
- At the northern end of the Finch tailtrack extension junction with the running tunnels, and
- At the southern end of the train storage facility adjacent to Richmond Hill Centre Station.

3.3.6 TRACK SUPPORT STRUCTURE

The track will be laid, in its entirety, upon noise and vibration isolated double ties, with the exception of the special trackwork areas. Floating slab support structures with noise and vibration isolation will be constructed in the special trackwork areas with direct rail fixation to the slabs.

3.3.7 EMBEDDED CONDUIT

Safety critical power supplies and communications cabling will be embedded in the safety walkways and inverts of tunnel structures. Cables to be embedded include:

- emergency trip;
- EAS telephones and other telephones;
- UPS to wayside mini-substations/load centres for tunnel lighting and utility outlets;
- fibre optic cables for the backbone communications system and for the needs of York Region;
- 27.6kV power supply to selected passenger stations (see Section 4.6);
- SCADA cables to shorting switches, mini-substations, sump pumps, emergency exit buildings, electrically operated isolation switches, all emergency ventilation equipment wiring that may be in the tunnels, including tail track ventilation damper control wiring, and
- Power for tunnel pump stations.

As illustrated on **Figures 3-1 and 3-2**, most conduits will be embedded in the safety walkway for the box and bored tunnel structures and will be embedded within the invert through crossovers. The conduits will terminate in station AC switchboard rooms or station communications equipment rooms. The embedded conduit will be accessible at junction/pull boxes from the track-way at intervals not exceeding 125m and at cross passages and emergency exit buildings

Additional embedded conduits and sleeves are provided in the tunnels at wayside equipment locations and for traction power tie breakers and cross bonds for the negative reinforcing cables.

In stations, embedded conduits are provided for communications cabling and essential power supplies as well as signals cables access to the train-ways.

3.4 Emergency Exits and Cross Passages

Emergency exits will be located such that the distance from any point in the tunnel to an exit does not normally exceed 381 m. Emergency exits will be provided in the tunnel sections at the following locations:

- one EEB between Cummer Station and Steeles Stations; approximately 480m north of Cummer Station and 550m south of Steeles Station;
- one EEB between Steeles Station and Clark Station; approximately 327m north of Steeles Station and 560m south of Clark Station;
- three EEBs between Clark Station and Langstaff Station; the first EEB is located approximately 327m north of Clark Station at the low point of the alignment extension and consequently will also house a pump station; the second EEB is located in the south approach structure approximately 115m south of the East Don River Bridge, and the third EEB is located approximately 668m south of Langstaff Station;
- one EEB between Langstaff Station and Richmond Hill Centre Station located approximately 614m north of Langstaff Station and 320m to the south end of Richmond Hill Centre Station (164m to the start of the Richmond Hill Crossover). This EEB will exit in close proximity to Highway 7 as there is no opportunity to construct an EEB within the Highway 407 Corridor. Due to the proximity to existing roadways, embankments and stormwater ponds, this EEB location may require passengers to overflow onto the Highway 7 on-ramp from Yonge Street. During the next stages of design, consideration should be given to seeking a variance from TTC to the requirement to provide an EEB between Langstaff and Richmond Hill Centre Stations or creating sufficient passenger spaces at the exit of the EEB; and,
- Two EEBs will be provided for the train storage facility, the first is located approximately 600m north of Richmond Hill Centre Station and the second at the north end of the train storage facility, the location of these EEB's are shown in Figure 13-1.

Cross-passages, which provide access between twin tunnels or box structures outside of station areas, will be provided at intervals of approximately 380 m. Typically cross-passages will be located at:

- emergency exits;
- between stations and emergency exits that are spaced further than 380 m;
- between adjacent emergency exits that are spaced further than 380 m;
- to access the EEB in the train storage facility. A 20m gap is provided between stored trains to enable personnel to cross between tracks.

4. SYSTEMS OPERATION & CONFIGURATION

This section summarizes the configuration of key system elements from an operational perspective. Detailed description of the proposed system characteristics, traction power configuration, and tunnel ventilation can be found in **Appendices 'B', 'C', and 'D'** of this report.

4.1 Service Requirements

This section defines the service requirements for the line, including definition of operating hours, passenger-carrying capacity required in peak/off-peak, fleet size, train configuration, planned service patterns, station-to-station travel times and station dwells.

4.1.1 RUN AND DWELL TIMES

Train run times will be established for the line using a rail operations simulator. The simulator uses train performance and alignment characteristics (horizontal and vertical). Station dwells currently assumed for this purpose are 30 seconds for Finch, 15 seconds for line stations (30 seconds for Steeles Station as a result of additional passenger volumes) and 120 seconds for Richmond Hill Centre Station. Round trip running times will be produced from the simulations. Travel time estimates based on assumed average travel speeds and with some allowances for distances between stations, curves and gradients are indicated in **Table 4-1**. The design basis is for every other Yonge Subway train to continue from Finch Station to Richmond Hill Centre Station with an average headway of 3.5 minutes (210 seconds) based on ATO. Based on the assumptions above, the estimated round-trip time between Finch Station and Richmond Hill Centre Station is approximately 32 minutes.

4.1.2 FLEET SIZE AND TRAIN CONFIGURATION

The capacity of the Yonge Subway is currently estimated to be 26,000 passengers per hour; however, the system has been observed to carry 28,400 passengers which is about 9% over the theoretical capacity.

As noted in Section 4.1.1, the design basis is for every other Yonge Subway train to continue from Finch Station to Richmond Hill Centre Station with an average headway of 3.5 minutes (210 seconds) during the peak hour based on Automatic Train Operation (ATO). This would result in about 17 train trips per direction in the peak hour. Given that the standard load of a new "Toronto Rocket" subway train (6-car consist) is expected to be 1,100 passengers per train, the line capacity between Finch Station and Richmond Hill Centre Station is expected to be approximately 18,700 passengers per direction. If the projected demand of 20,130 passengers north of Finch Station was achieved, the segment between Finch Station and Richmond Hill Centre Station would be about 8% above the theoretical line capacity by 2031. To address this issue, train operations may be altered by extending all train service to Richmond Hill Centre Station.

Although the opening day passenger demand has not been documented, it is expected to be in excess of the level that can be accommodated by a BRT on Yonge Street for the following reasons:

- The planned land use density at each of the proposed stations;

- The volume of passengers delivered to the Richmond Hill Centre by the new VivaNext BRT operating on Highway 7 and Yonge Street north of Highway 7; and
- The existing demand on the various YRT/Viva services which are quickly approaching capacity.

Table 4-1: Estimated Round-Trip Time between Finch Station and Richmond Hill Centre Station

From	To	Link Travel Time (sec.)	Dwell Time (sec.)	Cumulative Time (sec.)
	<i>at Finch</i>		30	30
Finch	Cummer	85		115
	<i>at Cummer</i>		15	130
Cummer	Steeles	135		265
	<i>at Steeles</i>		30	295
Steeles	Clark	130		425
	<i>at Clark</i>		15	440
Clark	Langstaff	265		705
	<i>at Langstaff</i>		15	720
Langstaff	Richmond Hill Centre	170		890
	<i>at Richmond Hill Centre</i>		120	1010
Richmond Hill Centre	Langstaff	160		1170
	<i>at Langstaff</i>		15	1185
Langstaff	Clark	255		1440
	<i>at Clark</i>		15	1455
Clark	Steeles	140		1595
	<i>at Steeles</i>		30	1625
Steeles	Cummer	135		1760
	<i>at Cummer</i>		15	1775
Cummer	Finch	85		1860
	<i>at Finch</i>		30	1890
TOTAL TIME		1560	330	1890 (31.5 min.)

4.2 Track Plan

Figure 4-1 presents a schematic diagram of the YSE track from the existing Finch Station to the Train Storage Facility north of Richmond Hill Centre Station. The track plan complies with the requirements for "subway" alignment as defined in the TTC Design Manual. Specific features of the track plan are discussed in the following sections.

Figure 4-1: Yonge Subway Extension Track Schematic

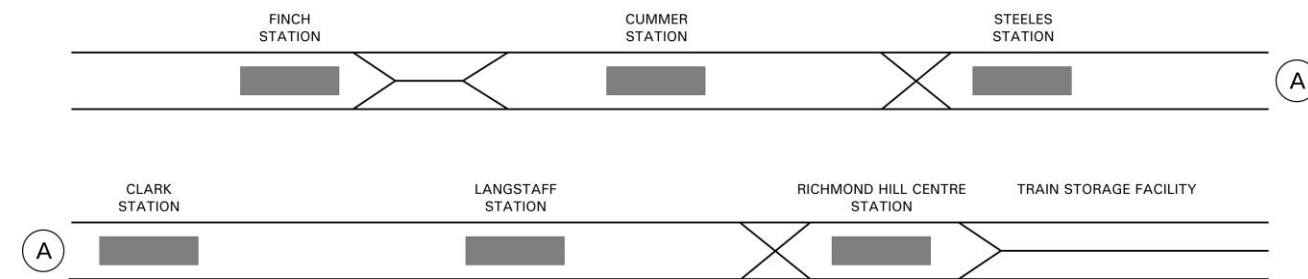

4.2.1 FINCH STATION

A double crossover currently exists south of Finch Station. The crossover will allow for short turns to support the current direction that every other train will short turn at Finch and will be used for failure management and maintenance operations. A centre pocket track currently exists north of Finch Station. The pocket track will be extended to form a double-ended pocket track and therefore will be accessible from both the south and the north. The primary purpose of the pocket track is to support schedule short turns of trains during peak period operations. A disabled train can also be stored in the pocket track. This configuration is illustrated in **Figure 4-2**.

Figure 4-2: Finch Station Special Trackwork

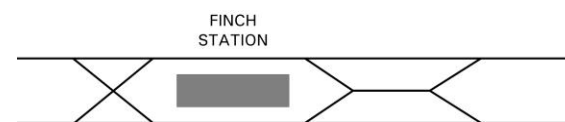

4.2.2 STEELES STATION

As illustrated on **Figure 4-3**, a double crossover will be installed south of Steeles Station. The crossover will allow for short turns for schedule recovery and will be used for failure management and maintenance operations.

Figure 4-3: Steeles Station Crossover



4.2.3 RICHMOND HILL CENTRE STATION

The Richmond Hill Centre Station is provided with a front double crossover to facilitate standard terminal station operations. Two tail tracks will be provided within a triple cell structure. The structure includes a centre pocket track forming part of the train storage facility. The configuration is illustrated on **Figure 4-4**.

Figure 4-4: Richmond Hill Centre Station Special Trackwork

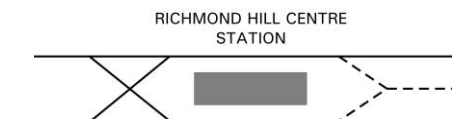

4.2.4 TRAIN STORAGE FACILITY

Immediately north of the Richmond Hill Station tail tracks, a 738m long triple box section is provided to house 12 trains for overnight storage. One or two trains will be kept at the Richmond Hill Centre Station platforms overnight. Only light duty maintenance and interior cleaning of the trains will occur at this location and all major maintenance will continue to occur at the Wilson Yard. Facilities (parking, elevator, office space) will be provided at the north end of the train storage facility and a transportation office will be provided at the south end of the Richmond Hill platform to facilitate bringing trains into service. This configuration is illustrated on **Figure 4-5** and the train storage facility is discussed in more detail in Section 11. As this facility was not part of the initial Yonge Subway TPAP, a separate TPAP will be required to obtain approval for this facility.

Figure 4-5: Train Storage Facility Track Schematic

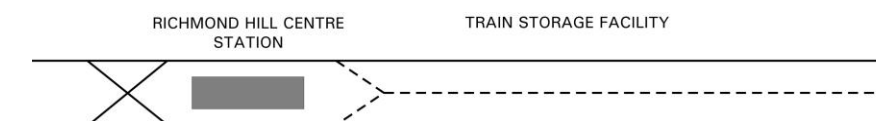

4.3 Vehicles

4.3.1 REVENUE TRAINS

Revenue service will be operated with Toronto Rocket series subway vehicles. The Toronto Rocket cars are configured in 6-car train sets.

The track and platform dimensions on the Yonge Subway Extension will accommodate the standard 6-car Toronto Rocket train and allow for a future 7-car train. Platform lengths will be built to the same length as the existing YUS platforms (152.4m).

The revenue train configuration will be 6-car trains for purposes of overall track planning, service and operations planning. These trains will be stored overnight at the underground train storage facility to be located north of Richmond Hill Centre Station.

4.3.2 WORK TRAINS

Existing electric and diesel powered work trains will operate on the line during non-revenue service periods. These vehicles will originate from Davisville Yard.

4.4 Traction Power

Traction power will be supplied at 600V DC (nominal voltage level) from traction power substations located at passenger stations and distributed to the trains by way of the third rail power distribution system. The substations will also supply station power at 27.6kV or 600Volt AC to the associated passenger station AC Electrical room. Traction power substations will be located at Cummer, Steeles, Clark, and Richmond Hill Centre Stations as well as the vicinity of the former Royal Orchard Station.

Each traction power substation will be fed from two independent high voltage circuits from the power utility company to improve overall reliability and availability of power. **Figure 6-6** schematically illustrates the high voltage power supply configuration.

Figure 4-6: Yonge Subway Extension High Voltage Power Supplies

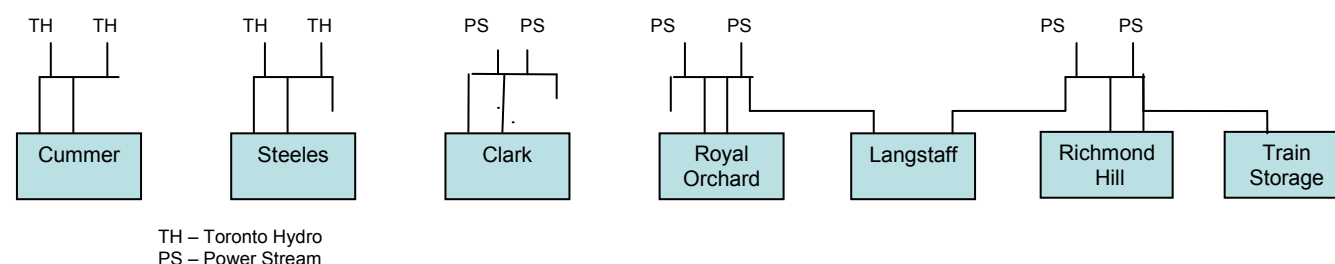

4.4.1 CUMMER, STEELES, AND CLARK SUBSTATIONS

A traction power substation will be installed at Cummer, Steeles, and Clark Stations. Two 1500kW rectifiers will be provided at the traction power substation. AC power will be fed at 27.6kV or 600Volt AC from the traction power substation to the passenger station AC Electrical room.

4.4.2 ROYAL ORCHARD SUBSTATION

As discussed in Section 2, the current project does not include a passenger subway station at Royal Orchard; however, there is a requirement for traction power substation in the vicinity of the former Royal Orchard Station and the final location is to be determined during the next stage of design. Power from the substation will be fed via a conduit duct bank to EEB #5 and from EEB#5 to the tunnels. Two 1500 KW rectifiers will be provided at the traction power substation. AC power will be fed at 27.6kV or 600Volt AC from the traction power substation to the adjacent passenger station AC Electrical room via the tunnels. Conduit provisions will be made in the safety walkway embedded conduit for the feeder cables.

4.4.3 LANGSTAFF STATION

A traction power substation will not be required at Langstaff Station. The station power substation will be fed with 27.6kV AC from both the Royal Orchard traction power substation and the Richmond Hill traction power substation through the tunnels. Conduit provisions will be made in the safety walkway embedded conduit for the feeder cables.

4.4.4 RICHMOND HILL CENTRE SUBSTATION

A traction power substation will be installed at the northern end of Richmond Hill Centre Station. Two 1500kW rectifiers will be provided at the traction power substation. AC power will be fed at 27.6kV or 600Volt AC from the traction power substation to the passenger station AC Electrical room. Richmond Hill traction power substation will also feed Langstaff Station and a satellite substation at the north end of the Train Storage Facility with a 27.6kV AC service through the tunnel. Conduit provisions will be made in the safety walkway embedded conduit for the feeder cables.

4.4.5 POWER CONTROL AND TRACTION POWER RAIL CIRCUITING

The traction power system will be monitored and controlled using the Supervisory Control and Data Acquisition System (SCADA) from Transit Control Centre. Local traction power cuts can also be initiated from any Emergency Alarm Station (EAS). Depressing the emergency trip switch at the EAS will cause feeder breakers supplying power to the zone along with any tie breaker associated with the traction power zone to open. Transit control will be notified of the trip by the SCADA system. **Figure 4-7** schematically shows the traction power feed circuiting for a typical YSE power section.

Figure 4-7: Typical Traction Power Rail Feeds

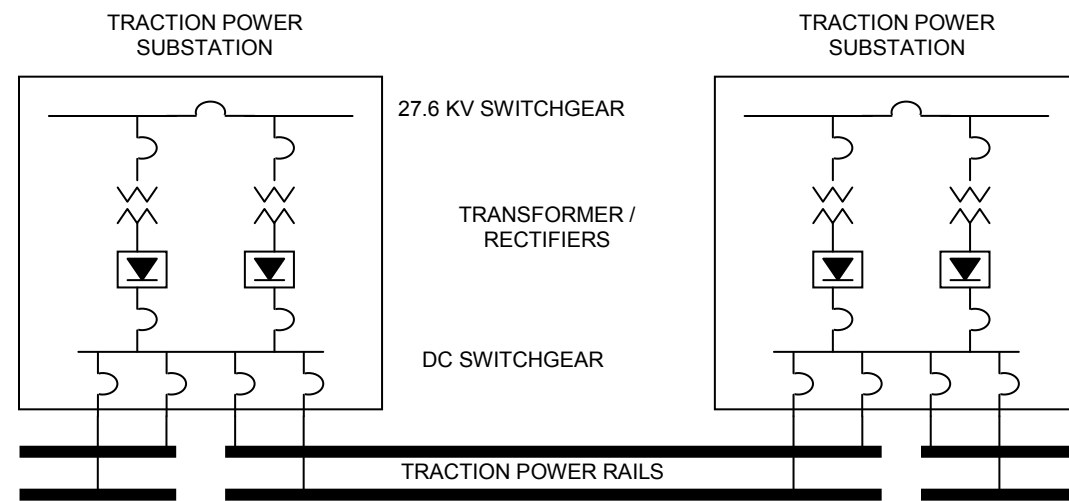

Shorting switches will also be strategically located to support wayside maintenance activities. The shorting switches connect the traction power rail to the negative return rail and lockout the associated traction power feeder breakers to ensure that the traction power rail cannot be energized while personnel are working on or near the rail.

4.5 AC Power

The traction power substations at passenger stations will also supply their host passenger station with AC power. Langstaff Station and the Train Storage Facility will not have a traction power substation and will be sub-fed from the adjacent substations by way of 27.6kV cables installed in embedded conduits within the tunnels. Langstaff Station will be sub-fed from Clark and Richmond Hill traction power substations. The Train Storage Facility will be sub-fed from Richmond Hill traction power substation.

4.6 Essential Power

Uninterruptible Power Supplies (UPS) will be provided at each station. The UPS system will provide a minimum of 3 hours of battery power for life safety and essential services within the station, substation and underground running structure. Electrical loads requiring essential power will be connected to these distribution panels.

UPS loads will include:

- automatic sliding station entrance doors*
- PED system (if applicable)
- emergency lighting and illumination of emergency exit signs
- fare collection and vending equipment*
- security systems
- fire booster pumps*
- communication systems
 - P.A. system

- CCTV system
- intercom system
- fibre optics system
- TTC telephone system (PAX)*
- public telephone system*
- passenger information system displays *
- radio system
- emergency ventilation supervisory control systems*
- SCADA / station control system
- Emergency Trip Logic Cabinets, and
- Signal system.

Items (*) identified above are currently being considered for removal from the UPS system. If adopted, a revision to the Design Manual would be implemented.

The essential power from the redundant UPS system will be distributed to several distribution panels to feed the essential loads. The UPS units have multiple power supplies. Two AC supplies from the station switchboard will be provided and should all station power be lost, a third supply from the traction power contact rail through an inverter will be provided.

Provisions will also be made for a temporary connection of a portable diesel driven generator should an outage continue and the contact rail is de-energized. A connection box will be located near the entrance to each passenger station to provide for easy connection of a portable generator. The generator will provide power to the UPS system plus some other essential loads required to maintain critical control and monitoring systems.

Demand on the UPS system will be reduced if the rated threshold will be exceeded and the external generator is not available. The equipment being supplied by the UPS will be configured to a safe condition, such as opening sliding doors, prior to disconnecting from the UPS. The UPS loads will be prioritized and the loads shed in accordance with the priority order.

Tunnel installed equipment including lighting, power receptacles, EOIS and radio installations are also supplied from station UPS systems. Typically, power from station supplies is fed at 600V AC to mini-substations/load centres located in cross passages or EEB's where it is transformed to 120V AC and fed to lighting and receptacles. The power feeds to the mini-substations are embedded in the safety walkway while the distribution to the lighting fixtures and power receptacles is in surface mounted conduit. Tunnel lighting is configured with every other light fed from alternate load centres.

A separate battery-backed emergency power supply will also be provided for traction power substation control and monitoring.

4.7 Tunnel Ventilation

A tunnel ventilation system will be provided in accordance with the requirements of NFPA-130. The ventilation system will be designed to:

- Create an airflow over the incident train of sufficient strength to control the flow of smoke and provide a smoke free evacuation and/or access route;
- Provide the capability of continuous mechanical ventilation effect in tunnel areas where diesel work cars are used, and
- Reduce the piston effect on the air velocity at station platforms.

The tunnel ventilation system will comprise fan rooms located at each end of each station. Each new fan room will contain two fully reversible fans. Ventilation shafts will be provided at each corner of the station footprint, just beyond the ends of the platforms. The fan assemblies, dampers and plenums are configured so as to allow the full capacity of the fans to be directed to one or both tunnels, in either the supply or exhaust direction. Two ventilation fan rooms housing two half capacity fans, fully reversible will also be provided at the northerly end of the Train Storage Facility to assist in the ventilation of the tunnels north of the Richmond Hill Centre Station.

The tunnel ventilation system is configured so that fans at adjacent sections can be operated in supply mode or exhaust mode to create a longitudinal “push-pull” ventilation response in the desired direction of ventilation.

Figure 4-8: Tunnel Ventilation Operation

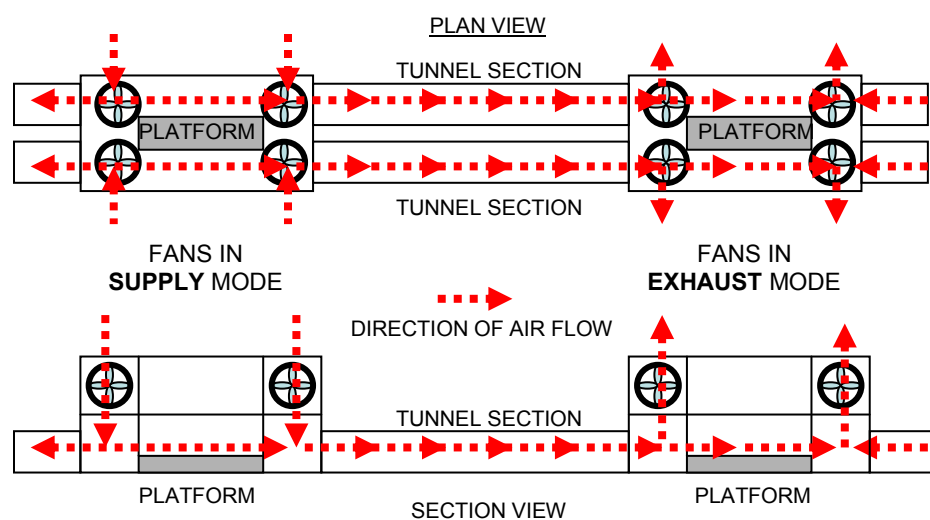

During a fire emergency the tunnel ventilation fans, and associated equipment, will operate in the appropriate pre-defined sequence (mode) in order to provide smoke control in the desired direction. The ventilation system equipment will be controlled from the Transit Control Centre using the SCADA System. Local control will also be provided from the Central Alarm and Control Facility (CACF) located in the vicinity of the attended entrance at each station. Control of the ventilation equipment at the adjacent stations is also provided at the CACF to set up the ventilation system in the required mode of operation. Local fan control for maintenance purposes as well as back-up control in an emergency situation when remote control is unavailable is also provided at each fan assembly.

5. GEOTECHNICAL

5.1 Overview

SPL Consultants Limited (SPL) was retained by the Toronto Transit Commission (TTC) to conduct a preliminary geotechnical investigation in support of the conceptual design for the Yonge Subway Extension (YSE). This work was initiated and completed in 2010. The scope of work for this investigation, which consisted of a total of twelve (12) boreholes, was outlined in a work plan prepared by Golder Associates Ltd. (Golder) entitled "Proposed Field Work and Geotechnical Laboratory Testing Plans for Conceptual Design, Yonge Subway Extension, Contract A" dated February 17, 2010. It was intended that this investigation program be complementary to an earlier programme undertaken in 2009 by Golder Associates which consisted of advancing thirteen (13) boreholes to depths of between 29.6 and 49.2m. Due to cost considerations, the actual programme implemented was somewhat limited in the area of the proposed train storage facility. The factual report, referenced herein, compiled by SPL presents the records of all boreholes, the soil, geotechnical and environmental laboratory test data, groundwater level records, in-situ hydraulic conductivity results and groundwater environmental quality test results.

- "Geo-Engineering Factual Data Report, Conceptual Design Investigation, Yonge Subway Extension (Version 2), Contract Y85-10", SPL Consultants Ltd., November 15, 2010.

5.2 Geotechnical Reports for Conceptual Design

A Preliminary Geotechnical Report was prepared for the Yonge Subway Extension Transit Project Assessment Process in 2009 (Golder Associates Ltd., 2010). This report and the above-referenced Geo-Engineering Factual Data Report prepared by SPL forms the basis for a series of geotechnical reports prepared for the Conceptual Design. The objectives of these reports are to provide information on the anticipated subsurface soil and groundwater conditions at the proposed station sites, along the proposed Twin Tunnels alignment, at the East Don River Bridge and for the Train Storage Facility. Recommendations provided in these reports are intended to provide conceptual design information that may be utilized toward planning and costing purposes. Geotechnical reports prepared for this Conceptual Design are as follows:

- Yonge Subway Extension, Cummer/Drewry Station, Toronto, Ontario dated March 2011;
- Yonge Subway Extension, Steeles Station, Toronto and Regional Municipality of York, Ontario dated March, 2011;
- Yonge Subway Extension, Clark Station, Regional Municipality of York, Ontario dated February, 2011;
- Yonge Subway Extension, Langstaff Station, Regional Municipality of York, Ontario dated March, 2011;
- Yonge Subway Extension, Richmond Hill Centre Station, Regional Municipality of York, Ontario dated February, 2011;
- Yonge Subway Extension, Twin Tunnels, Toronto and Regional Municipality of York, Ontario dated March 2011;

It should be noted that at this conceptual design stage, the subsurface information contained in the above reports is insufficient for preliminary or final design. Following the completion of the conceptual design, additional explorations, testing, review and revision of the recommendations contained in the various reports will be necessary during preliminary and detail design stages.

5.3 Design Basis

The selection of temporary ground support systems will require consideration of the anticipated excavation depth, temporary surcharges (live and dead loads) that may be acting immediately behind the temporary retaining wall, groundwater levels and tolerance of nearby facilities to ground displacements. The main objective of the temporary ground support is to control the vertical and lateral movements induced from temporary excavations, which may affect adjacent facilities including buildings and basements, buried utilities and paved areas. The majority of the excavation support systems for the Yonge Subway Extension are expected to be soldier piles with lagging combined with a suitable internal bracing or strut system provided that an adequate dewatering system is in place for this option. Dewatering may vary from simple control of surface water and seepage at the interface between fill and upper till (Cummer and Steeles Stations) to more complex multi-stage eductor systems (Langstaff, Richmond Hill Centre and the Train Storage Facility.)

Where stiff temporary support systems are required to control the ground movement or where groundwater cut off is considered desirable, continuous concrete wall options such as secant piles (contiguous caissons) and diaphragm walls may be considered. This system is likely to be needed for Clark Station where dewatering flows would be excessive with a soldier pile and lagging system.

5.4 Future Subsurface Explorations and Testing

Based on the available information and conceptual design, specific recommendations have been provided in each of the reports to determine in greater detail, the extent and continuity of specific stratigraphy layers as well as installing boreholes with observation wells/piezometers/multiple vibrating wire piezometers to better assess the groundwater requirements. In addition, pumping tests will be required to better predict dewatering flows.

5.5 Comparative Summary of Yonge Subway Extension Requirements

Soil and groundwater pressures generate the majority of the design load that must be resisted in the design of underground structures. To compensate for the limited structural design effort undertaken at this initial level of conceptual design, a summary table (**Table 5-1**) has been developed that provides an overview of the geotechnical conditions (subsurface conditions and dewatering issues) expected for the Yonge Subway Extension.

Table 5-1: Preliminary Comparison of Soil and Groundwater Control Conditions

Yonge North Subway Section	Overview of Subsurface Conditions	Overview of Foundation, and Excavation Support Conditions	Overview of Dewatering Issues
Finch Station and Cross-Over	<ul style="list-style-type: none"> 10 to 15 m thick cohesive till trending to granular till toward north; over 10 to 15 m thick granular deposits; over Cohesive till below elevations 165 to 170 m; and Groundwater levels below base of excavation 	<ul style="list-style-type: none"> Conventional soldier piles and lagging except adjacent to any critical structures; Contiguous caisson (secant pile) walls adjacent to critical structures; Deep foundations needed only in areas of thick fill (if present) of for large column loads 	<ul style="list-style-type: none"> Conventional sump pits and pumps to control seepage from discontinuous granular layers Majority of construction in this area should be above the static water levels
Cummer/Drewry Station	<ul style="list-style-type: none"> 10 to 15 m thick cohesive till trending to granular till toward north; over 20 to 25 m thick granular deposits; over Cohesive till below elevations 155 to 170 m; and Groundwater levels below base of excavation 	<ul style="list-style-type: none"> Conventional soldier piles and lagging except adjacent to any critical structures; Contiguous caisson (secant pile) walls adjacent to critical structures; Deep foundations needed only in areas of thick fill (if present) of for large column loads 	<ul style="list-style-type: none"> Conventional sump pits and pumps to control seepage from discontinuous granular layers Majority of construction in this area should be above the static water levels
Steeles Station and Cross-Over	<ul style="list-style-type: none"> 10 to 15 m cohesive till; over 20 to 25 m granular deposits (within base of excavation level); over Cohesive till below about elevation 155 to 165 m; and Groundwater levels near elevation 168 m, below base of excavation level 	<ul style="list-style-type: none"> Conventional soldier piles and lagging except adjacent to any critical structures; Contiguous caisson (secant pile) walls adjacent to critical structures; Deep foundations needed only in areas of thick fill (if present) of for large column loads 	<ul style="list-style-type: none"> Conventional sump pits and pumps to control seepage from discontinuous granular layers Majority of construction in this area should be above the static water levels
Clark Station	<ul style="list-style-type: none"> Highly variable subsurface conditions; 2 to 12 m cohesive till; over 10 to 15 m granular soils imbedded with cohesive layers 1 to 7 m thick; over 2 to 5 m cohesive soils; over Granular soils to bedrock at elevations 140 to 142 m; Groundwater pressure levels in upper granular layers variable; and Groundwater levels in granular layers at and below invert close to ground surface with upward hydraulic gradient. 	<ul style="list-style-type: none"> Use of conventional soldier piles and lagging may be limited because of groundwater control requirements Secant pile or concrete diaphragm (“slurry”) walls may be required for groundwater cut-off Station buoyancy may be problematic – may require tension piles or additional counter weight from structure 	<ul style="list-style-type: none"> Multi-stage educators will likely be required for dewatering of layered deposits Deep wells may also be required for depressurization of underlying aquifers Cut-off groundwater may be required to limit dewatering-induced settlement or reduce flow rates Cut-off walls could extend to bedrock at depths of about 35 m Cost-benefit evaluation of dewatering and cut-off walls necessary
East Don River Cut and Cover Section (South)	<ul style="list-style-type: none"> Highly variable subsurface conditions; 3 to 10 m cohesive till; over 5 to 15 m granular soils interbedded with cohesive layers 1 to 5 m thick; over 2 to 15 m cohesive till over; 10 to 20 m granular soils to bedrock at elevations 125 to 137m; Groundwater levels in upper granular layers at or near surface; and Groundwater levels in lower granular layers 10 m below surface 	<ul style="list-style-type: none"> Use of conventional soldier piles and lagging may be limited because of groundwater control requirements Secant pile or concrete diaphragm (“slurry”) walls may be required for groundwater cut-off Structure buoyancy may be problematic - may require tension piles or additional counterweight from structure 	<ul style="list-style-type: none"> Multi-stage educators will likely be required for dewatering of layered deposits Deep wells may also be required for depressurization of underlying aquifers Cut-off groundwater may be required to limit dewatering-induced settlement or reduce flow rates Cost-benefit evaluation of dewatering and cut-off walls necessary
East Don River Bridge	<ul style="list-style-type: none"> Highly variable subsurface conditions Interbedded cohesive and granular layers Buried meander channels Bedrock 30 to 35 m below ground surface, approximately elevations 135 to 145 m; and Groundwater levels near river level at about elevation 160 m in granular layers rising to 170 m near the north abutment 	<ul style="list-style-type: none"> Deep foundations will be required (piles or caissons) Driven piles preferable to minimize potential for problems associated with artesian water flow. Cobbles may be present in sand and gravel layers from about elevation 148 m (22 m below ground). Likely a need for driven sheet piles to form cofferdam around pile cap excavations 	<ul style="list-style-type: none"> Local dewatering using combination of systems for pile cap construction Artesian water flow may complicate foundation design

Yonge North Subway Section	Overview of Subsurface Conditions	Overview of Foundation, and Excavation Support Conditions	Overview of Dewatering Issues
East Don River Cut and Cover Section (North)	<ul style="list-style-type: none"> • Cohesive till typically less than 5 m thick; over • Cohesive deposits 10 to 15 m thick; over • Granular soils at about elevations 155 to 160 m; • Bedrock at about elevations 145 m; and • Groundwater levels rising from elevation 165 m to near 175 m from river northward, near structure invert level 	<ul style="list-style-type: none"> • Conventional soldier piles and lagging except adjacent to any critical structures; • Contiguous caisson (secant pile) walls adjacent to critical structures 	<ul style="list-style-type: none"> • Multi-stage eductors will likely be required for dewatering of layered deposits • Deep wells may also be required for depressurization of underlying aquifers
Longbridge/Langstaff Station	<ul style="list-style-type: none"> • Cohesive till about 10 to 15 m thick; over • Granular soils typically less than 5 m thick, near structure invert; over • Cohesive soils to about elevation 165 m about elevation 185 m; • Groundwater elevation in granular soils at about surface elevation; and • Groundwater elevation near 180 m in cohesive soils 	<ul style="list-style-type: none"> • Conventional soldier piles and lagging except adjacent to any critical structures; • Contiguous caisson (secant pile) walls adjacent to critical structures 	<ul style="list-style-type: none"> • Multi-stage eductors will likely be required for dewatering of layered deposits
RHC Station	<ul style="list-style-type: none"> • Granular soils to about elevation 190 m; over • 5 to 10 m of cohesive soils; over • Granular soil at about elevation 170 m; • Groundwater elevation at about 188 to 190 m, near station invert 	<ul style="list-style-type: none"> • Conventional soldier piles and lagging except adjacent to any critical structures; • Contiguous caisson (secant pile) walls adjacent to critical structures 	<ul style="list-style-type: none"> • Multi-stage eductors will likely be required for dewatering of layered deposits • Deep wells may also be required for depressurization of underlying aquifers
Underground Train Storage*	<ul style="list-style-type: none"> • Granular soils to about elevation 193 m; over • 7 to 12 m of granular till to about elevation 185 m • Groundwater elevations in upper water-bearing soils from about elevation 189 m to 195 m and from about elevation 196 m to 204 m from south to north, respectively 	<ul style="list-style-type: none"> • Conventional soldier piles and lagging except adjacent to any critical structures; • Contiguous caisson (secant pile) walls adjacent to critical structures\ • Contiguous caisson or diaphragm walls may also be required for groundwater control 	<ul style="list-style-type: none"> • Multi-stage eductors will likely be required for dewatering of layered deposits • Deep wells may also be required for depressurization of underlying aquifers
Twin Tunnels	<ul style="list-style-type: none"> • See descriptions above for station areas and vicinity • Frequent mixed face of hard cohesive glacial till and saturated granular soils • Full face of granular soils above groundwater between Finch and Grandview Avenues (north of Steeles Station) • Boulders and cobbles throughout all soil deposits 	<ul style="list-style-type: none"> • See descriptions above for station areas and vicinity 	<ul style="list-style-type: none"> • See descriptions above for station areas and vicinity

*Scope of investigations and available data is insufficient in the area of the planned storage facility

6. STATION DESIGN CONSIDERATIONS

6.1 Approach

The station designs presented in this document are functional in nature and have been developed to provide context for the cost estimate. There has been no attempt to create any architectural expression at this stage. The primary purpose in developing the station designs has been to establish how they fit into the alignment and the surrounding neighbourhoods at each location.

At the project outset it was decided that the YSE station designs should be seen as an evolution of the Sheppard Subway station designs completed in 2002. The Sheppard Subway stations are located primarily under Sheppard Avenue making this a good comparison for the stations located under Yonge Street. The more complex intermodal facilities, such as Steeles and Richmond Hill Centre stations, should reference best practice from similar facilities around the world, taking into account the specifics of TTC and YRT standards and operations.

For the YSE project, the design philosophy being recommended is to keep the station boxes as short as possible and to minimize station volume. There will typically be no dramatic volumes of space or places within the station overlooking features such as from the concourse level to the platform level. The station appearance will be determined by the artificial lighting and the colour and pattern of the finish materials.

6.2 Architectural Design Philosophy

The architectural design philosophy for the YSE stations is to provide high quality architecture, urban design, streetscape, and landscape architecture with:

- Increased potential for Transit Oriented Development (TOD), with entrances that can be assumed into future development as economically as possible;
- Increased civic aspirations at urban gateways (particularly Steeles and Richmond Hill Centre);
- Sustainable facilities which minimise negative impact on the environment, and meet the Toronto Green Standard;
- Clearly identifiable entrance facilities that allow daylight to penetrate to lower levels where economically feasible;
- Circulation routes to vehicle boarding points that are convenient, intuitive, straight forward, well signed, comfortable, and well lit;
- Obvious and convenient intermodal transfers;
- Train and bus platform area that offer visual diversions to help pass the time, such as public art, architectural design, televised media, advertising etc.;
- Emergency egress routes that are clear, convenient, and safe;
- Coordination and integration with the South Yonge Street Corridor Streetscape Master Plan Study; and

- Barrier-free with at least one fully accessible entrance.

6.3 Station Design Guidelines

The station designs on the Yonge Subway Extension (YSE) will be influenced by many factors. While the YSE is primarily located under Yonge Street, it is critical that station areas support existing land use policies that recognize Yonge Street as a primary inter-regional corridor and requires the highest quality of urban design. As such, the basic station configuration, particularly at entrance level will have more in common with the Sheppard Subway than the recently designed Toronto-York Spadina Subway Extension (TYSSE) stations. Following is a set of design guidelines that will govern the YSE stations. Note that at this stage of the project the stations are only being developed to a concept level (3%).

6.4 Station Planning

6.4.1 BACKGROUND

The Yonge Extension is a continuation of Toronto's first subway which was initially opened from Union Station to Eglinton Avenue in 1954. Subsequent extensions from Eglinton Station to Finch Avenue were completed between 1954 and 1974. North York City Centre Station was added in 1987.

TTC stations in conjunction with land use designation and zoning have played a significant role in shaping urban development in the Yonge Street corridor at station locations. The entrances of many of the underground stations are now incorporated within large commercial developments. It is expected that this approach would be continued in the Yonge Subway Extension as development occurs.

6.4.2 TRANSIT ORIENTED DEVELOPMENT

Stations should be planned with entrances oriented for convenience for existing and future development. Consideration should be given in planning the unpaid area of stations to accept future private development entrances. To increase the possibility for TOD a number of accommodations are required:

- Locate collector's booth and farelines at Concourse level;
- Note that automatic farelines should remain at surface wherever possible to meet Crime Prevention Through Environmental Design (CPTED) requirements;
- Minimise fare paid areas to allow free movement of unpaid patrons through stations;
- Provide knockout panels, at a minimum to all quadrants of the station;
- Design surface entrance structures to facilitate assimilation into future development;
- Design substations with high aesthetic values, including views from above;
- Locate emergency exit buildings (EEBs), emergency vent shafts and HVAC shafts to reduce impacts that may limit development; and
- Provide a continuous concourse to maximize connectivity between quadrants where practicable

6.4.3 CIVIC ASPIRATIONS

Transit stations are a public amenity whose primary function is to provide access between trains and the surface. As such, they can and do reflect the many qualities and aspirations of a society at a given time. This is often reflected in the architecture, through choices of materials, public art, spatial articulation, station volume, colour, surface entrance design, signage etc. Some stations are given special treatment as a result

of their location, projected passenger demands, opportunities to support high TOD or special occasions they may have to accommodate.

Options for civic expression are most appropriate at “gateway” locations such as Steeles and Richmond Hill.

There are numerous social, transport and economic benefits to be gained from this project as already indicated. At this stage of the project it is incumbent on all parties involved in the project to seek out cost effective solutions which will allow the project to proceed.

6.4.4 PROPERTY IMPACTS

All stations, with the exception of Richmond Hill Centre, are located under the Yonge Street Right of Way. The entrances to stations will in most cases require private property acquisition beyond the existing road right-of-ways. Entrances should be sized and located such that they are easily identifiable. Private property may also be required for station ventilation shafts, bus facilities, PPUDOs, substations, and emergency egress buildings. In all cases the facilities should be designed to minimise land take.

6.4.5 FARE INTEGRATION

There are operating benefits to integrating fares between TTC and other transit authorities running transit into these facilities. The biggest benefit is in the intermodal stations, where additional fare barriers have been shown in this report. Fare integration would remove these barriers and significantly improve station operations. Until fare integration issues have been confirmed, stations need to be designed to accommodate the multiple fare media systems of the transit agencies involved. Any fare integration plan must accommodate the needs of Viva, YRT, GO, TTC and Presto

6.4.6 INTERMODAL TRANSFER

Intermodal transfers will occur at all stations. Site layouts should seek to make the connection between modes as obvious, safe and convenient as possible. Transfers will continue at Finch Station however a significant portion of the current transfers will be relocated to Steeles, Clark and Richmond Hill Centre stations.

Transit authorities aim to reduce the amount of time taken to transfer between modes of transit. One approach is to design the facility so that transferring passengers do not have to pass through a fare barrier; this is known as a “free-body connection”. The benefits of different modes making a free-body connection into the paid area of the station should be examined at each location. Weather protection should be provided where possible throughout the entire transfer area.

6.4.7 SUSTAINABILITY

Both the City of Toronto and York Region have sustainability requirements, and local municipalities in York Region are developing them. While these will serve as a guide in the design of the station facilities, the objective must always be to design solutions which minimise energy consumption and negative impact on the environment. This may be done by using materials which are economical, long lasting, easily recyclable, and

require low energy consumption to produce. Opportunities to reduce the overall energy consumption of the station should be identified as early as possible in the design process.

A list of the key relevant sustainability guidelines for stations will be developed as part of the next stage of design.

6.4.8 TECHNOLOGY

The stations will be designed to accommodate the new “Toronto Rocket” trains being purchased by the TTC. To protect for operational flexibility, these stations will be designed with 152.4m (500 foot) long platforms to match those on the existing Yonge Subway. This ensures that the operation of longer trains (i.e. a seventh car) is not precluded. It is assumed that these trains will operate with an Automatic Train Operation (ATO) signalling system. Stations will also be designed to accommodate future installation of full height, partial segregation platform edge doors (PEDs).

6.5 Station Zones

Underground transit stations can be characterised into five and sometimes six zones: surface entrance, concourse, platform, circulation, and bus facility. These zones are connected by circulation routes, mechanical and electrical equipment rooms support the operation and maintenance of the station. Many stations also require a traction power substation which, although not publicly accessible, is the sixth zone. The following figure is a diagram of the station zones.

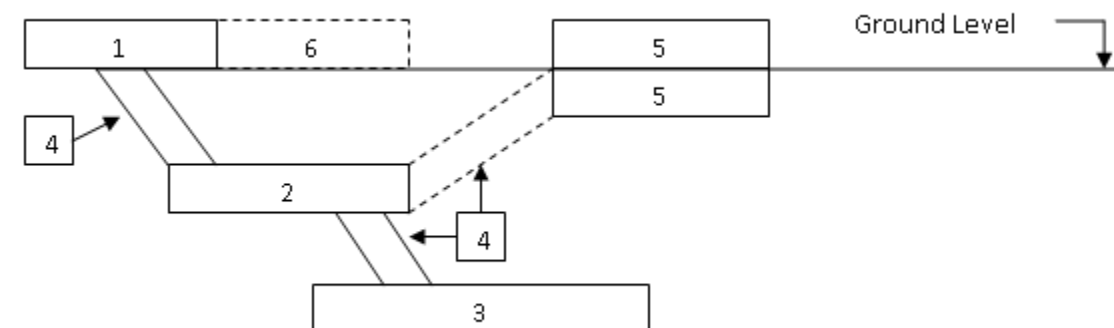

1. Entrance Building
2. Concourse
3. Platform
4. Circulation
5. Bus Facility
6. Substation (Traction Power)

There is an endless variety of architectural approaches to the design of subway stations throughout the world. The following principles are proposed for each zone in the Yonge Subway Extension stations. These will be expanded through further consultation.

6.5.1 ZONE 1 – THE ENTRANCE BUILDING

The entrance facility should be designed to fit in spatially with the planned local urban context. It should be obvious that it is an entrance to the subway. It should be transparent; its structure should be economical and lightweight. Where there is likelihood that the entrance structure could be incorporated into a future development, the enclosure should be as economical as possible. Where appropriate and possible, the enclosure should incorporate as much glass as possible to meet CPTED requirements and permit daylight harvesting. Where economically feasible, daylight should be allowed to penetrate through entrances to lower station levels.

Main entrances include an elevator, stairs, and escalators to the concourse. Station identity signage will also be required. Consideration should be given to organize or minimize the “urban fill” that is inevitably attracted to station entrances such as newspaper boxes, garbage bins, and recycling bins.

6.5.2 ZONE 2 – THE CONCOURSE

The concourse is usually located below ground in order to reduce surface land take. It also allows for the possibility of street underpasses and interconnections with adjacent development and bus facilities. This zone needs to accommodate the functional requirements of the fare system, operational spaces (mechanical, electrical, and emergency ventilation), knockout panels for future developer connections, and connects all other zones within the station.

A requirement of the Ontario Building Code is that transit stations have two separate means of egress from platform to surface. Traditionally this has meant separate concourse levels, or the addition of Station Emergency Exit Buildings (SEEBs). However, emergencies in other transit systems have shown that in an emergency, patrons will egress by following the familiar routes by which they entered the station. So the starting point for the design of these stations is to layout the service spaces to divide the concourse level into two separate public concourses. In this way there are two completely separate entry routes to these stations making egress clear and direct. In order to increase safety and increase passenger convenience, a fire-separated public corridor has been added to link the two concourses.

A prototypical plan and spatial configuration of the concourse level can be found in **Figure 6-1**.

Figure 6-1: Prototypical Plan and Spatial Configuration - Concourse Level

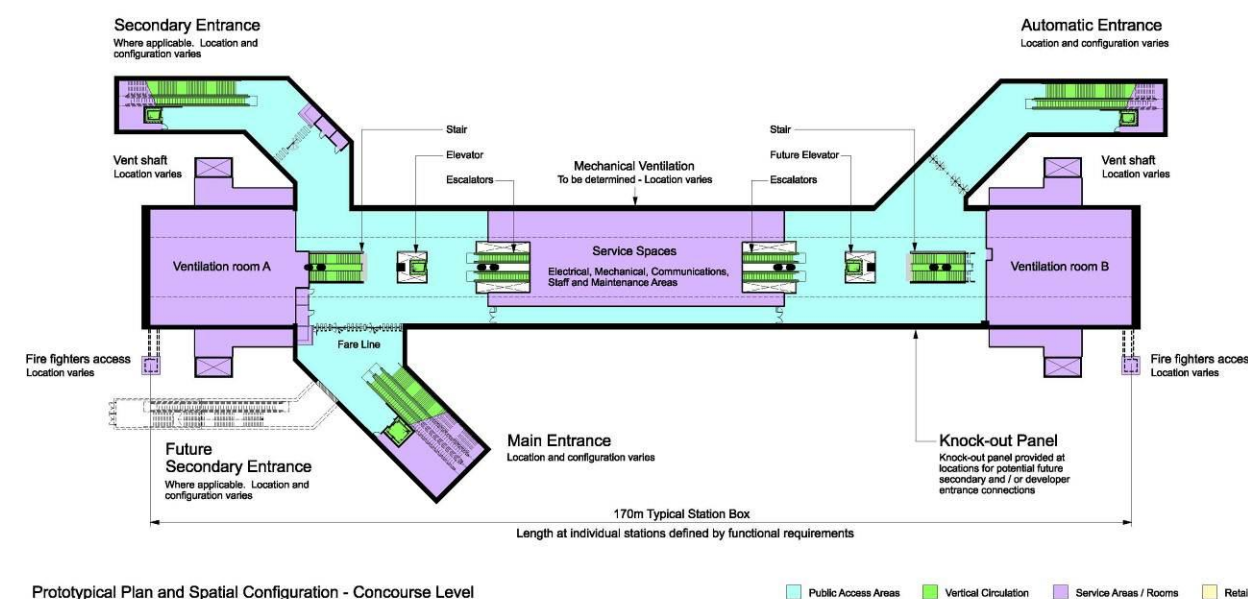

Straight forward “way finding” is essential for both inbound and outbound passengers.

The architectural volume of the space will be a function of its location underground. It does not need daylight. However if the sense of daylight can be seen from the concourse for outbound passengers it will contribute to “way finding” and security. It will no doubt benefit staff working in ticket booths.

Finish materials should reflect the maintenance and life cycle requirements of a transit station. It is proposed that each station would develop its own architectural character within this space similar to the Sheppard Subway and TYSSE. This would be done using a pallet of materials that are deemed suitable for transit stations.

6.5.3 ZONE 3 – THE PLATFORM

The Yonge Subway Extension platforms will be designed to accommodate future installation of platform edge doors (PEDs) at full height with partial segregation for ventilation. There is one precedent for this in Toronto – the LINK people mover at the Toronto Pearson International Airport. PEDs have been installed in numerous cities around the world – initially in Singapore but are not common to North America. PEDs essentially change the nature of passenger’s relationship to the train. The platform is now enclosed and the effective width of the platform is reduced. The PED wall will incorporate sliding doors and windows that allow visibility between the train and platform.

An objective on the platform area is to provide as much free circulation area as possible. Every effort should be made to maximise structural column spacing, and where economical remove them. The vertical circulation elements – such as elevators, stairs, and escalators – also influence circulation area to a great extent. Finish materials should be similar to the concourse.

Most of the Yonge Subway Extension platforms should be below Yonge Street and will therefore be limited in terms of vertical height. However every effort should be made to give passengers the sense of the way in/out of the station. Visual precedents for this space will be gathered from other metro systems. Platforms should be designed to direct most passengers to the south end of platforms where possible, particularly at major stations such as Steeles and Richmond Hill. This will help the existing downstream problems as some of the downstream stations direct the majority of passengers to the north end of the platforms which results in an uneven distribution of passengers within the train. This uneven distribution is further compounded with the large volume of passenger transfers at Yonge / Bloor predominantly located at the north end of the train. The new Rocket Trains which allow passengers to transfer between cars on the train will also help to balance passenger loading.

A prototypical plan and spatial configuration of the platform level can be found in **Figure 3-2**.

Figure 6-2: Prototypical Plan and Spatial Configuration - Platform Level

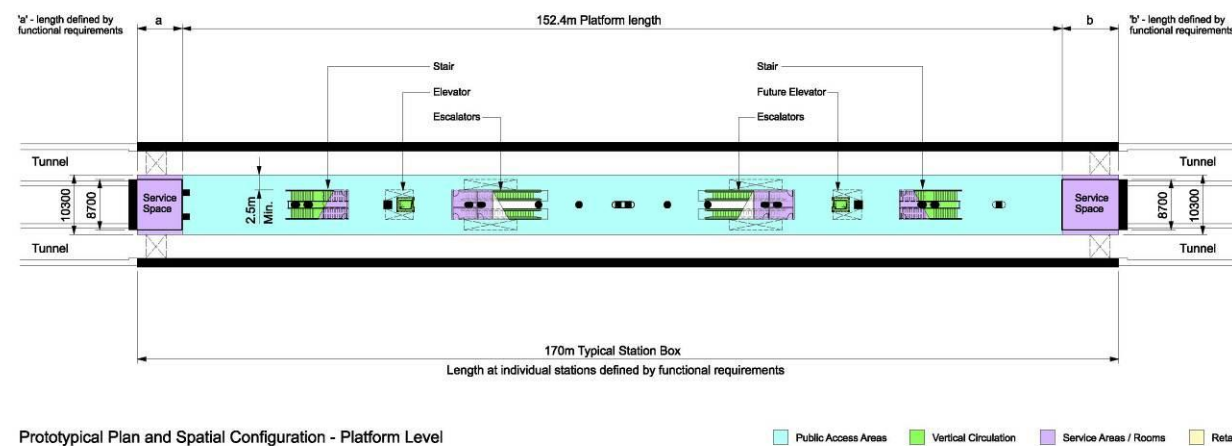

compromise the goals of Transit Oriented Development. However, localising bus interchange below ground level is not unprecedented and can shorten the bus to subway transfer distance for passengers.

At this stage of the project development it appears that the Steeles bus facility will be below ground within the Steeles Avenue right-of-way and the Richmond Hill Centre bus station will be at ground level and may ultimately be built over. The portion of the bus platform at Steeles Station serving TTC bus routes will be within the TTC fare paid zone, while the portion serving YRT routes will be outside of the fare paid zone. The Clark Station bus loop and the Richmond Hill Centre Station bus terminal will be entirely outside of the fare paid zone. These assumptions must be revisited if fare integration is introduced.

In addition to the requirements of TTC bus terminals, YRT facilities require waiting area heating, washrooms, and additional fare equipment.

6.5.6 ZONE 6 – SUBSTATION (TRACTION POWER)

Most station will require a traction power substation to provide both power for train operations, and station power. While these facilities are not accessible to the public, they are a very visible element that has urban design impact and may restrict transit oriented development (TOD). Every effort should be made to reduce the TOD impact and design a facility that integrates into the urban design, streetscape, and landscape of the local community.

6.6 Station Design

6.6.1 PASSENGER EXPERIENCE

A passenger's experience of a station is quite different than that on the train. A passenger may spend 2 to 6 minutes moving through a station and waiting for their train, while they could be on the train for 15 to 30 minutes. Bus passengers may wait from 2 to 30 minutes for their bus.

Passenger expectations will vary with age, gender, culture, physical ability, education, experience of using public transit, frequency of use and desire for security and safety. To some extent a public transit station must cater to all these requirements.

A transit station is a place where one should have a convenient, safe, short wait for a transit vehicle; in an environment that is clean and well maintained. To support these functional requirements one would expect the station to consist of:

- clearly identifiable surface entrances that are well lit at all times of the day with weather protection, good signage, and a clear path to and from all transit modes;
- circulation routes towards vehicle boarding points that are convenient, intuitive, straight forward, well signed, comfortable, and well lit;
- simple fare payment with fare machines that allow for queuing without interrupting passenger flows.
- platform area that offers visual diversions to help pass the time. These could be in the form of art, design, televised media, advertising etc.;

6.5.4 ZONE 4 – CIRCULATION WAYS

The width of circulation routes needs to reflect the number of passengers likely to use the station for both normal and emergency egress mode. A barrier-free access route must be provided between the surface and the platform. The sense of direction between the entrance/exit points to the destination within the station should be as visually obvious as possible. Routes should not have blind or hiding spots.

Stations have currently been designed with two barrier-free routes on the assumption that one will be built on opening day, and the other will be protected for future installation. Future barrier-free routes will most often be at developer connections.

Finish materials should be similar to the concourse.

6.5.5 ZONE 5 – BUS FACILITY

Under current fare conditions, TTC bus facilities should be located within the fare paid zone of the system. From the operating perspective it is preferable to have the bus facility at ground level, though this may

- Emergency egress routes that are clear, convenient, and safe. It should be clear how a passenger can contact someone in authority during an emergency situation; and
- Amenities that add to the comfort and convenience of the journey.

The public ownership and civic nature of transit stations creates an opportunity to enliven, and enrich the experience of coming and going from the train while meeting the functional and operational requirements. This is done largely through the manipulation of spatial volume, structure, natural and artificial light, materials and colour, and public artwork.

TTC Policy is for public artwork to be integrated into the design and construction of stations with a budget of a minimum of 1% of the cost of creating the public spaces, including structure and mechanical electrical equipment.

6.6.2 WAY FINDING

Design clear and logical passenger circulation to reduce the need for wayfinding signage. All signage will conform to TTC signage standards with the addition of other transit agency signage as required.

6.6.3 PERSONAL SECURITY

Security in a transit station is provided by giving passengers a sense that they will not be personally violated either physically or mentally while waiting for a train. All public facilities will be design to meet TTC CPTED requirements. Within a transit station this will be accommodated by creating open well lit spaces where there is no place for someone to hide.

Design circulation routes to avoid sharp turns or dead end corridors. There is obvious means to contact someone in authority in the event of an emergency or suspicious event. CCTV is provided and passengers are aware that it is operational and being monitored for all levels of the station including the bus terminal.

The introduction of Platform Edge Doors (PEDs) will enhance security by eliminating the chance of a person falling into or being pushed onto the trainway.

The TTC uses a Designated Waiting Area (DWA) to indicate a safe place for waiting for transit vehicles and being in contact with TTC staff. Additional “blue light” or other emergency stations will be considered within parking lots and bus terminals.

6.6.4 BUILDING REGULATIONS

NFPA – 130 has been used to define the fire, life safety requirements by some transit authorities since the 1980’s. The Province of Ontario adopted a modified version of this document in its building regulations in Section 3.13 Rapid Transit Stations.

The Yonge Subway Extension stations will be designed to meet the requirements of OBC 3.13 latest edition, and the applicable sections of NFPA - 130.

6.6.5 TTC DESIGN STANDARDS

The TTC, like most other transit agencies, has a number of design standards which reflect the unique functional operational climate and maintenance requirements of the system. These have been updated by varying degree since the 1950’s when the system started operating. The design standards developed within the Rapid Transit Expansion Programme in the 1990’s subsequently served as a precedent for updates to standards used in New York, London and Singapore.

At this stage of the project those standards which relate to station planning, alignment, structure, utilities, power supply and ventilation are most relevant.

The standards should not be applied blindly; they should not limit the possibility of innovation or adaptation to a specific site location or conditions. However, this should be carefully reviewed as changing standards can have a significant impact on the budget.

6.6.6 ACCESSIBILITY

Design stations to accommodate barrier-free access to all publicly accessible levels. Protect for additional barrier-free routes in stations which require only a single route on opening day. Note that TTC requires all developer connections to be barrier-free.

6.6.7 HEALTH AND SAFETY

The health and safety needs of all people who operate and maintain the transit station must be considered. Some of these requirements are identified within the TTC’s Design Manual. Other requirements will be determined as the design progresses.

6.6.8 VENTILATION

Most underground transit stations are ventilated by the air that is pushed into and pulled out of a station by moving trains. The velocity of the air being pushed into the station is considered to be too high, so relief ventilation shafts are required. These are located at both ends of platforms. In addition these shafts can also be used to remove smoke, assisted by fans, in the event of a fire on a train within the station or in the tunnel between stations. With the advent of platform screen doors it may be possible to reduce the surface area of the vent shafts. To confirm the size of shaft and fans a Subway Environmental Simulation SES analysis will be performed.

The design of the vent shafts at the ground surface will need careful consideration from a functional, safety, and urban design perspective. Recent TTC projects have permitted ventilation grilles flush with grade finishes within sidewalks that will be ploughed clear of snow by the relevant municipality, otherwise all vents must be located at a minimum of 1m above grade.

6.6.9 FARE COLLECTION

New stations require a fare barrier, incorporating some kind of fare paid confirmation device. The barriers also act as means for security and crowd management. The TTC is presently looking at alternative fare media systems and fare integration as mentioned in section 6.4.5.

6.6.10 TRAIN LOADING

Consideration should be given to directing passengers to move to the south end of the platforms to encourage south loading Yonge Subway trains as they progress their journey south from Richmond Hill Centre. This will impact the arrangement of vertical circulation between entrances, concourse, and platform. However, there is a tendency for regular passengers to board a train considering where they would get off at their destination station. The need to encourage south loading of trains is driven primarily by the heavy north weighted boarding loads between Finch and Bloor stations on the Yonge Subway during the AM peak. Having passengers directed to the south end of the train will also provide some relief of the conflicts between transfers at the Yonge / Bloor station. The new Rocket Trains which allow passengers to transfer between cars on the train will also help to balance passenger loading

6.6.11 PLATFORM CONFIGURATION

The Yonge Subway Extension platforms will be designed to accommodate the future installation of Platform Edge Doors (PEDs). It has been noticed in various transit systems with PED's that people tend to line up opposite the door thus reducing the holding capacity of the platform between train arrivals in peak periods. Passengers lining up at doors also make it difficult for people to move along a platform. Stations need to be designed to minimise obstructions to passenger movement and speed up unloading and boarding of transit vehicles.

The current preference is for centre, or island, platforms designed to the current TTC Design Manual width of 10.3m, with minimal columns. Any reduction of platform width could compromise future PED installation.

6.6.12 ELEVATORS AND ESCALATORS

Elevators and escalators are a key component for providing comfortable, convenient and safe access for all users between entrances and all levels of the station. Experience shows that the travelling public prefer escalators and elevators to stairs.

Elevators also play a key role providing barrier-free access for people with mobility issues and passengers using mobility devices.

To reduce the visual bulk of elevators and shafts and provide a more secure environment, it is proposed that glass is used as much as possible to allow vision into and through the elevator. Glass balustrades should be considered for use on escalators.

6.6.13 FINISH MATERIALS

It is preferable to use finish materials in transit stations that are hard wearing and have a long life (minimum 25 years). In part, this is to avoid the disruption that material replacement causes to the normal operation of a station. As a rule of thumb, the floor finish should have the highest allocated budget, followed by the walls and ceilings. Wall and ceiling finish material colour shall be neutral, e.g. white, to facilitate reduction in lighting illumination level losses. Consider design of finishes for ease of regular structural inspection and for future replacement.

The availability and performance of materials is constantly evolving. There is an opportunity with the Yonge Subway Extension in conjunction with the work being done on the Toronto-York Spadina Subway Extension to take a fresh look at materials considering; wear, life expectancy, cost maintainability and sustainability.

Public art will be integrated into all levels of these facilities.

6.6.14 STATION MAINTENANCE

A key component of station design is accommodating regular and intermittent maintenance; in particular, the need to remove and replace large pieces of equipment. A station that is easy to clean will reduce operating cost and extend the life of materials. Clean stations will assist in instilling a sense of pride and caring in customers.

Over the structural design life of a station the interior finishes will need replacement 3 to 4 times. Consideration should be given to the choice of finish materials and their assembly to reduce the impact of station upgrades in the future.

6.6.15 STANDARD ELEMENTS

The TTC has developed guidelines and designs for a number of physical features within a station such as railings, balustrades etc. Lessons learned from the TYSSE project should also be incorporated which contribute to ease of maintenance, operability, standardisation, and cost control.

6.6.16 LIGHTING

Most spaces in the station will be underground and therefore illuminated with artificial light. There has been a tendency on many transit stations to provide an even level of light throughout the entire space. This inevitably leads to over use of energy and creates a somewhat bland environment. Where appropriate, artificial lighting should be used to express the quality of space, while meeting the functional requirements. Lighting levels should vary according to use of the space. The use of LED lights should be considered.

6.6.17 SIGNAGE

The TTC has developed a standard graphic approach to signage. The applicability of this should be reviewed in so far as it applies to station platforms that will have PEDs.

6.6.18 COMMUNICATION SYSTEMS

CCTV and PA systems in public areas need to be carefully integrated into the architectural finishes, in an orderly manner, in order to avoid unacceptable cutting or jointing of finish materials. Intermodal stations, particularly Steeles and Richmond Hill, will need shared systems in some part of their facilities.

6.6.19 PUBLIC TOILETS

The TTC typically provides public toilets only at terminal stations. For the Yonge Subway Extension it is proposed that toilets be located at Richmond Hill Centre Station as it will be the new terminal station on the Yonge Subway.

Other transit agencies require public toilets within their elements of these stations, particularly the YRT bus terminals. At this point of design we have included public washrooms at Richmond Hill bus terminal

6.7 Other Facilities

6.7.1 DESIGN GUIDELINES

A number of additional transit facilities are required along this alignment; there are 8 Emergency Exit Buildings (EEBs), a stand-alone traction power substation at Royal Orchard, and a maintenance facility north of Richmond Hill Centre station. As these facilities are not used by the public, but are a visible element in the urban fabric, the design philosophy should be modified as follows:

Provide high quality architecture, urban design, streetscape, and landscape architecture with:

- Potential for facilities to be assumed into future development as economically as possible;
- Sustainable facilities which minimise negative impact on the environment, and meet the Toronto Green Standard or other local sustainability objectives;

6.8 Structural Design Consideration

Based on the station considerations discussed in the previous sections, the proposed YSE stations have evolved architecturally based on the Sheppard Subway stations completed in 2002 and the Toronto-York Spadina Subway Extension presently underway. Structurally, the direction that this study has proceeded is that a centre platform station with a structural centre column on the platform as portrayed in the TTC Directive Drawing 0205-00-07 will be the basic structural configuration for the subway station unless it can be demonstrated that a clear span structure results in a similar cost. This may be the case where the station box is subjected to major uplift forces from buoyancy.

6.8.1 DESIGN BASIS

Generally accepted practice for TTC underground structures is to provide a temporary excavation support system and an independent, permanent structure. The Contractor is generally assigned responsibility for selecting, designing and constructing the most appropriate type of excavation support system taking into account the soil stratigraphy, the groundwater conditions, the method of controlling or lowering the groundwater and the horizontal and vertical movement anticipated and their impact on adjacent buildings and structures, in accordance with design criteria stipulated in the construction contract. Primary requirements, therefore, are to provide a safe, stable and open excavation without danger of failure, and to limit ground movements that could damage adjacent property. This responsibility would extend to the design and construction of the decking system, where necessary, to maintain traffic during the construction phase.

The criteria for the design of the permanent station box structure are governed by the TTC Design Manual and reflect the loading conditions that could occur at various times in the life of the structure. The Design Manual establishes basic requirements for the design of underground structures based on limit states. In the design of the box structures, load factors are applied to the specified loads and the combined effects of these factored loads must be analysed to produce the maximum total factored load. To maximize effects on a

structure, both maximum and minimum load factors are applied in a series of plausible loading conditions each of which controls the design required of a portion of the box structure. This analysis will produce the maximum bending moments and shear forces necessary to determine the wall and slab sizes, including reinforcing steel requirements.

The depth of cover over the structure and the horizontal forces due to earth pressures and groundwater pressures generally govern the design of the underground structures. As noted in the Geotechnical Design Reports referenced in Section 8 of this document, the geotechnical investigations undertaken to date are preliminary only and considerably more investigative effort is needed to determine the design conditions and forces that must be analyzed for the permanent structure. For conceptual design, it is deemed to be more prudent to utilize pre-existing designs of underground stations that have been analyzed, in detail, for a similar set of design conditions (cover, groundwater conditions, structural configuration, column spacing).

6.8.2 STRUCTURAL ASSUMPTIONS FOR YONGE SUBWAY EXTENSION

To facilitate the capital cost estimate being prepared by Hanscomb, a typical structural cross section (see **Figure 6-3**) was prepared. This cross section satisfies the minimum clearance dimensions prescribed by TTC Directive Drawing 0205-00-07 and the minimum mechanical room clearance requirements adopted on the TYSSE project. It can therefore be applied throughout the station box length negating the requirement for end unit “penthouses”. The structural sizing is similar to that derived for Bessarion Station on the Sheppard Line which had a cover of more than 3m. As indicated, this is a centre platform station with columns spaced at approximately 10.5m -12.5m centres along the platform and with longitudinal beams at roof and invert levels.

Based on the comparative geotechnical and groundwater conditions described in Section 5, the cross section shown in Figure 6-3 is applicable to Cummer, Steeles, Langstaff and Richmond Hill Centre Stations.

The Geotechnical Report for Clark Station indicates that based on the preliminary data currently available, the groundwater levels in the vicinity of the station would be approximately 15-19m above the invert elevation of the station. Upward groundwater seepage into the proposed station excavation could therefore be expected during construction. Design and construction of the station box and temporary excavations will need to adequately address uplift forces acting on the station box and the excavation base, as well as avoiding unstable ground conditions and/or ground loss due to upward groundwater pressures and/or flow. For these reasons, the capital cost estimate for this station has been based on a temporary works system consisting of continuous concrete wall option (secant piles and/or diaphragm walls) keyed into bedrock. In addition, due to likely buoyancy issues, the typical structural cross section and quantities will be based on stations with similar conditions on TYSSE (York University, Highway 407 and Vaughan Corporate Center Stations).

Figure 6-3: Typical Cross Section of Station Structure with Centre Column

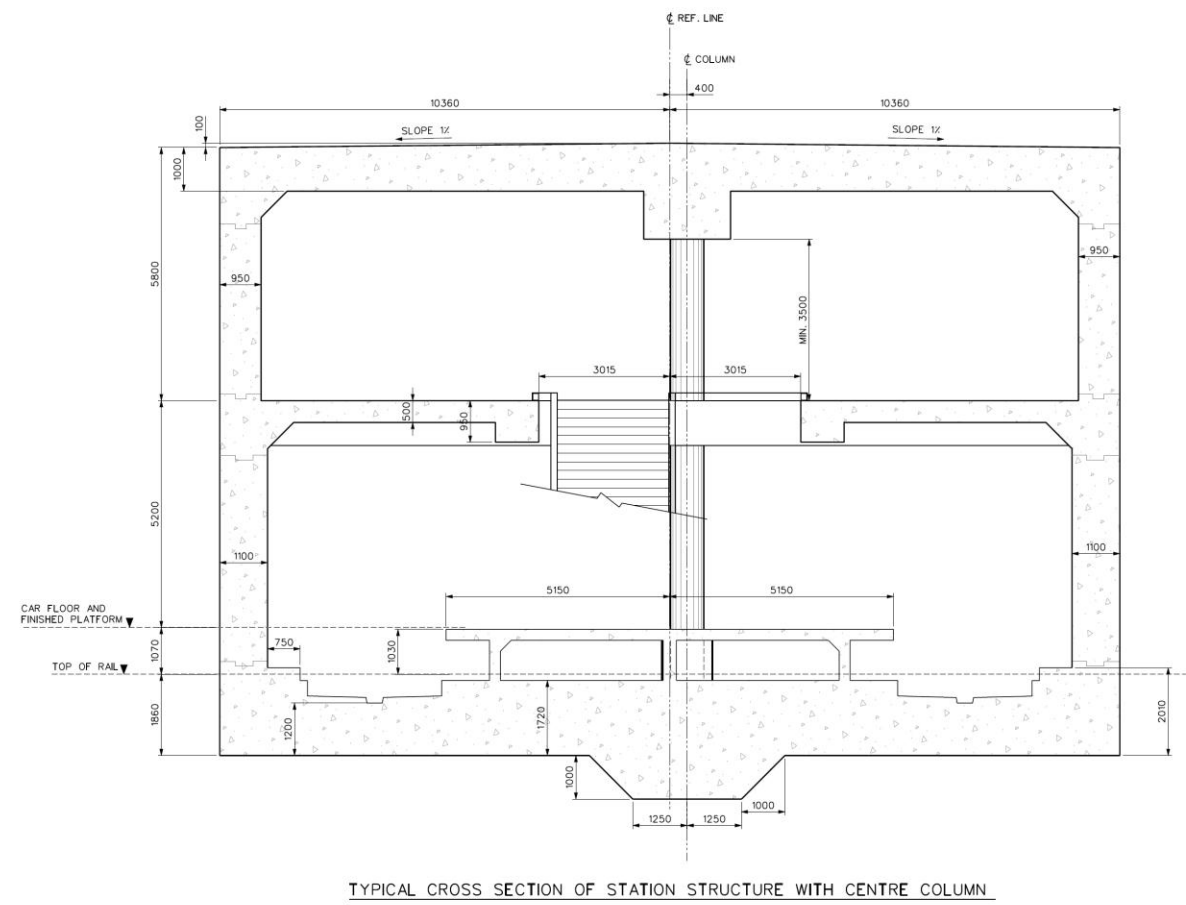

7. CUMMER STATION

Cummer Station will be located below Yonge Street with the majority of the station box located north of Cummer/Drewry Avenue. The main station entrance will be located on the northeast corner of Cummer Avenue and Yonge Street, with an automatic entrance proposed for the north end of the station on the west side of Yonge, with additional provision for knock-out panels for future secondary entrances. A two-level substation will be situated adjacent to and above the main entrance building.

The station's zone of influence covers an area bounded approximately by Hilda Avenue to the west, Willowdale Avenue to the east, Finch Hydro Corridor to the south, and Centre Avenue to the north.

Cummer Station will provide a good connection to local bus routes and a stimulus for future live/work development in the station area. The TPAP preferred option identified a main entrance building in the northeast and southwest corners of the Yonge Street/Cummer Avenue/Drewry Avenue intersection. These entrance buildings would provide easy access to the station from the Newtonbrook Shopping Centre, area strip malls, and apartment buildings from all corners of the intersection. TTC buses operating on Cummer Avenue and Drewry Avenue will pick-up and drop-off passengers directly in front of the entrance buildings.

7.1 Passenger Transfer Movements

The passenger transfer movements at Cummer Station were estimated based on the passenger demand forecast analysis described in Section 2 and Appendix 'A' of this report. A breakdown of the forecast 2031 AM peak hour transfer movements by mode and by direction can be found in **Table 7-1**.

Table 7-1: Estimated Passenger Transfer Movements at Cummer Station (2031)

TRANSFERS		OUT OF STATION					
		SUBWAY		TTC BUS		WALK OUT	TOTAL
INTO STATION	DIR	NB	SB	EB	WB		
SUBWAY	NB	0	0	120	10	400	530
	SB	0	0	30	0	50	80
TTC BUS	EB	0	250	0	0	0	250
	WB	30	630	0	0	50	710
WALK IN		100	450	10	0	0	560
TOTAL		130	1330	160	10	500	2130

As shown in Table 7-1, transfer movements at Cummer Station are largely split between the bus-subway pair and the walk-subway pair. Of the total 2,130 AM peak hour passenger movements projected at Cummer Station, about 50% (1,070) are between the subway and connecting bus routes while 47% (1,000) are between the subway and walk-in/out.

Passenger flow diagrams prepared for Cummer Station can be found in **Appendix 'E'** of this report.

7.2 Station Entrances

The Main Entrance is located on the northeast corner of Yonge Street and Cummer Avenue. An Automatic Entrance is located on the west side of Yonge Street midblock between Drewry Avenue and Connaught Avenue. The entrance building in the southwest corner of the intersection – identified during the TPAP as a required entrance on opening day – is now a future entrance that will be protected for but not constructed for opening-day operation. The entrance building in the southeast corner of the intersection – identified during the TPAP as a future entrance – has been protected for in the Conceptual Design. Both secondary entrances on the south side of Cummer and Drewry Avenues can be built as developer connections in the future. Given the location of the collector's booth and fare line at the concourse level, only the southeast connection can provide free access, whereas the southwest connection will require an automatic fareline.

Provision for a knockout panel to a future development on the east side of Yonge is provided from the concourse at the north end of the station; this will require the developer to add a full automatic fareline and provide stairs, elevator, escalators, and signage that must remain accessible through the same hours as the TTC station. Knockout panels are also included from the south concourse for the two future secondary entrances on the south side of Cummer and Drewry Avenues.

The Main Entrance is fully accessible with an elevator, two escalators, and stairs. The Automatic Entrance has been designed with an escalator, stairs, and provision for future installation of a second elevator route. We recommend that the structural elements of the second elevator route are built in order to reduce the cost and impact of adding this vertical circulation element in the future.

7.3 Street Level

Emergency ventilation shafts are located on both sides of Yonge Street south of the intersection with Cummer and Drewry Avenues. At the north end of the station, the new municipal storm sewer has forced both vent shafts to be located on the west side of Yonge Street adjacent to the Automatic Entrance. Note that additional station ventilation shafts are required for normal exhaust and makeup air to staffed spaces below grade, and will be sized and located in the next phase of design.

Fire Fighter's Access shafts are located on the west side of Yonge Street; one adjacent to the Automatic Entrance, and one on the southwest corner of Yonge and Drewry Avenue.

7.4 Concourse Level

In order to reduce the station box length, utility rooms have been located at concourse level thus dividing the concourse in two. This layout also provides the fire separation for two egress routes required under OBC 3.13 from platform to surface. A public passageway connects the two areas on the west side of the concourse with two sets of fire doors. It is likely that this corridor will also require sprinklers to meet code requirements. Emergency ventilation fans are also located at concourse level, with two fan assemblies located at each end of the station box.

Entering the concourse from the Main Entrance, patrons move past the Collector's Booth and through a low gate fare array. We are recommending the Collector's Booth be located on the south end of the fare array, contrary to the traditional "right-hand flow", in order that the collector will have the best view of the south

concourse and associated passenger flows. Moving through the fare line, patrons have two escalators, a set of stairs, and an elevator to take them down to the platform level.

Entering the concourse from the Automatic Entrance, patrons move through a high gate fare array with provision for future installation of an Easier Access Portal Unit (EAPU). Patrons will have two escalators and a set of stairs providing access to the platform level. Provision has also been made for installation of a future elevator from the north concourse to the platform.

7.5 Platform Level

As noted previously, the center platform is 152.4m long to accommodate the current six-car train consists operated by the TTC. As this is the standard length for platforms in the TTC subway system, it is assumed that future ATC (Automatic Train Control) train operation will allow the operation of longer trains, including the possibility of seven-car consists.

Patrons move between concourse and platform using four escalators, two sets of stairs, and an elevator. Provision has been made for the addition of a second elevator route through the north concourse. Vertical circulation has been designed to accommodate both normal and emergency passenger loads using the normal vertical circulation elements. This is the preferred design approach, as observation has shown that in emergencies, people tend to follow familiar routes out of buildings rather than follow emergency exits routes.

7.6 Electrical Substation

Subsequent analysis carried out during the Conceptual Design assignment has shown that an electrical substation, providing traction power to the subway, would be required at Cummer Station. The TPAP concept did not include a substation at this location. The substation would be located above the Main Entrance building in the northeast corner of the Yonge Street/Cummer Avenue intersection.

7.7 Roads

An opportunity was identified during the TPAP to advance implementation of the approved planned extension of the North York Centre Service Road as part of the traffic management plan for the subway extension. The Service Road is an EA-approved public street that helps facilitate development and access along Yonge Street in the North York Centre Secondary Plan Area. The implementation of this section of the Service Road should play an important role in helping to mitigate traffic impacts related to the construction of the subway extension.

The Service Road extends from its existing intersection at Eglinton Avenue northerly to a new intersection at Drewry Avenue. The road runs north-south about 175m to 240m west of Yonge Street. Drewry Avenue would be widened between Yonge Street and the Service Road to accommodate a 4-lane cross section. The intersection with Drewry Avenue would be signalized if warranted.

7.8 Bus Loop

The bus loop is located on the north side of Drewry Avenue on the private properties identified during the TPAP. Buses enter the loop from the west driveway and circulate clockwise around an island platform. The

east driveway lines up with the south approach of the Service Road/Drewry Avenue intersection, with protection for any future further extension of the Service Road.

A bus loop was identified on the north side of Drewry Avenue to allow westbound bus service to the station to be short-turned at this location. Currently, bus services on Cummer Avenue (42 CUMMER) and Drewry Avenue (125 DREWRY) operate as separate routes. Typical ridership on 42 CUMMER is almost three times that of 125 DREWRY. Therefore, it was recommended during the TPAP to interline both routes and short-turn every other westbound bus at Cummer Station (i.e., at the bus loop). Illustrations of the proposed functional design of the bus loop can be found in **Drawings SK01H to SK03H**.

7.9 Utilities and Relocation Strategy

An existing storm sewer crosses Yonge Street across the future station box at approximately the same elevation as the concourse floor slab. This conflict compromises an otherwise generic station design and removes the option for a shallower alignment profile with side platforms.

To address the conflict between the existing storm sewer and the station box, the storm sewer will be relocated around the north end of the station box and reconnect to the existing pipe on the east side of Yonge Street. To achieve suitable deflections within the manholes, the station box was shifted south and the vent shafts at the north end of the station both outlet on the west side of Yonge Street. Due to the requirement to vent to the north of the station box, the typical fan layout has been modified, resulting in the whole station shifted approximately 12m south on the alignment.

The existing storm sewer continues east of Yonge Street within a City of Toronto easement. A proposed development which straddles this easement only has the opportunity for a subway entrance on the south side of the development into the concourse. The north side of the development does not have the opportunity for an entrance as the relocated storm sewer is in conflict.

The remaining utilities at the Cummer Station will be relocated beyond the subway box and will be protected during construction.

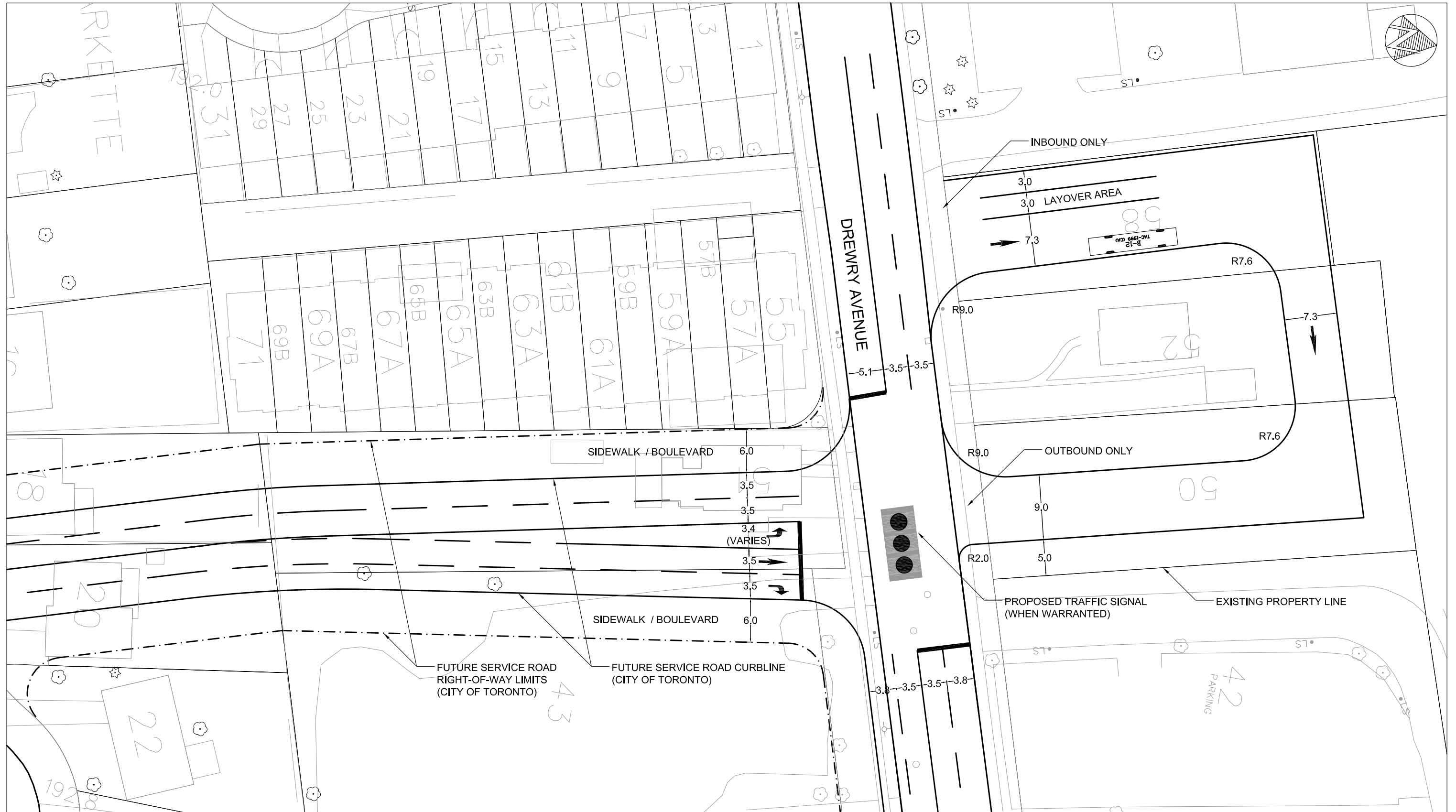

REVISIONS	REVISIONS
△	△
△	△
△	△

ISSUED FOR INFORMATION ONLY
NOT FOR CONSTRUCTION



DRAWN	D. INEGBEJE	2010/08/31
CHECKED	H. WANG	2010/08/31
CORRECT		
SCALE	0 5 10m	
	1:500	

YONGE SUBWAY EXTENSION
CUMMER STATION
TTC BUS LOOP FUNCTIONAL DESIGN

Contract No. Y85-9
Plot Date: \$\$\$\$SYTIME\$\$\$\$\$

TORONTO TRANSIT COMMISSION

Dwg. No. SK01H Sheet No.



REVISIONS	REVISIONS
△	△
△	△
△	△

ISSUED FOR INFORMATION ONLY
NOT FOR CONSTRUCTION



DRAWN	D. INEGBEJE	2010/08/31
CHECKED	H. WANG	2010/08/31
CORRECT		
SCALE	0 5 10m	
1:500		

YONGE SUBWAY EXTENSION
CUMMER STATION
YRT BUS LOOP BUS SWEPT PATH (EAST)

Contract No. Y85-9
Plot Date: \$\$\$\$SYTIME\$\$\$\$\$\$
TORONTO TRANSIT COMMISSION
Dwg. No. SK02H
Sheet No.



REVISIONS	REVISIONS
△	△
△	△
△	△

ISSUED FOR INFORMATION ONLY
NOT FOR CONSTRUCTION



DRAWN	D. INEGBEJE	2010/08/31
CHECKED	H. WANG	2010/08/31
CORRECT		
SCALE	0 5 10m	
1:500		

YONGE SUBWAY EXTENSION
CUMMER STATION
YRT BUS LOOP BUS SWEPT PATH (WEST)

Contract No. Y85-9
Plot Date: \$\$\$\$SYTIME\$\$\$\$
TORONTO TRANSIT COMMISSION
Dwg. No. SK03H
Sheet No.

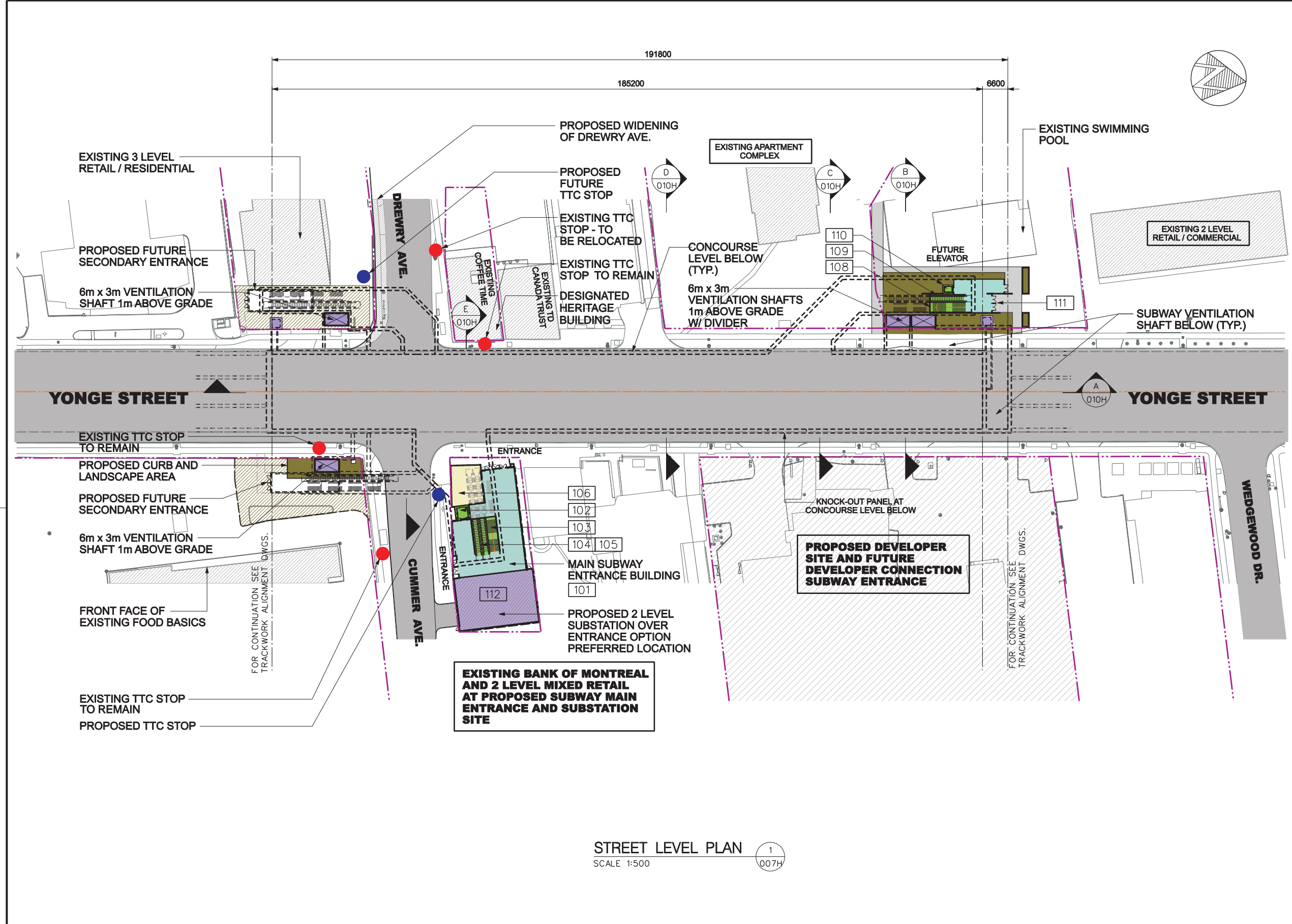

STREET LEVEL PLAN
SCALE 1:500

ROOM SCHEDULE LEGEND

RM. No.	ROOM NAME	APPROX. RM. AREA
101	MAIN SUBWAY ENTRANCE	315
102	ELEVATOR 1	-
103	STAIR 1	-
104	ESCALATOR 1	-
105	ESCALATOR 2	-
106	RETAIL	80
107	STORAGE - TBD	TBD
108	STAIR 2	-
109	ESCALATOR 3	-
110	FUTURE ELEVATOR 2	-
111	AUTOMATIC ENTRANCE	82
112	ELECTRICAL SUBSTATION	935

ROOM LEGEND - TYPICAL SUBSTATION

RM. No.	ROOM NAME	APPROX. RM. AREA
	HYDRO INCOMING LINE METERING	6
	SUBSTATION CONTROL ROOM	300
	CABLE ROOM	VARIES
	BATTERY ROOM	18
	WASHROOM	5
	STAFF LUNCH ROOM	10
	RECTIFIER ROOM	90
	TRANSFORMER YARD	300-350
	STORAGE	10
	MECHANICAL ROOM	TBD
	SERVICE ROAD /YARD	AS REQ'D
	SERVICE STAIR	* AS REQ'D
	FREIGHT LIFT /SHAFT	* AS REQ'D
	FREIGHT LIFT MACHINE RM.	* AS REQ'D

* AS REQUIRED PER INDIVIDUAL SUBSTATION

LEGEND

- ROAD
- ELEVATED ROAD
- PUBLIC AREA
- SERVICE ROOMS
- VERTICAL CIRCULATION
- RETAIL
- LANDSCAPE AREA
- NORMAL OPERATION EXIT WAY

DRAWING No. SHEET No. FILE BLDG. REF. No.

REVISIONS	REVISIONS

CONCEPTUAL DESIGN
NOT FOR CONSTRUCTION

Hatch Mott MacDonald

MRC McCORMICK RANKIN CORPORATION
A member of MMM GROUP

DRAWN _____
CHECKED _____
CORRECT _____

SCALE 0 5 10 15 20m

YONGE SUBWAY EXTENSION

CUMMER STATION
STREET LEVEL
CENTRE PLATFORM

Plot Date: 8/26/2011

TORONTO TRANSIT COMMISSION
ENGINEERING DEPARTMENT

Dwg. No. **SK-A-007H** Sheet No. _____

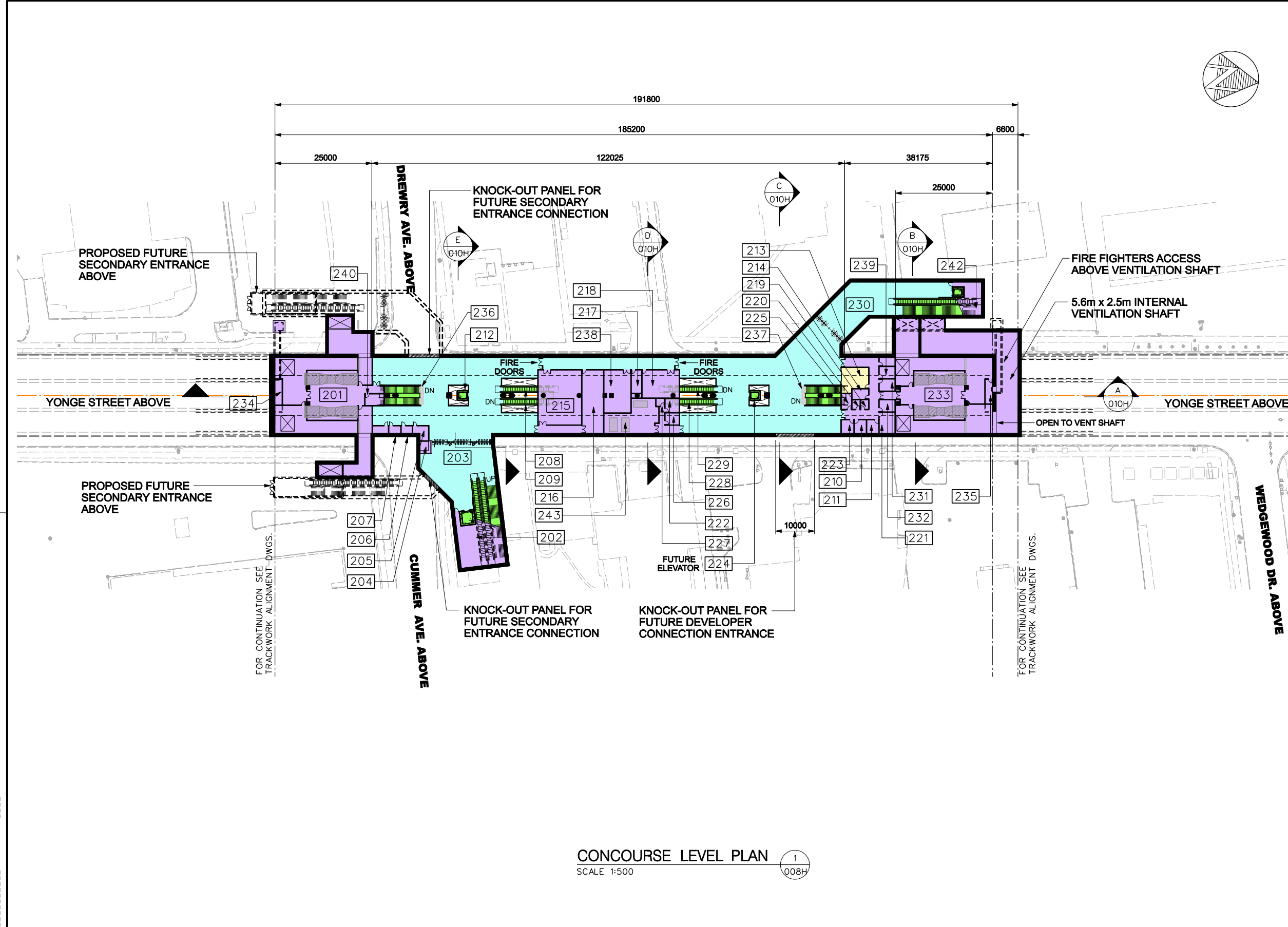

ROOM SCHEDULE LEGEND		
RM. No.	ROOM NAME	APPROX. RM. AREA
201	SUBWAY VENTILATION RM.	500
202	ELEV./ESCALATOR MACH. RM.	-
203	FARE LINE	-
204	COLLECTOR'S BOOTH	-
205	COLLECTOR'S ANTEROOM	-
206	COLLECTOR'S WASHROOM	-
207	PIPE SPACE	TBD
208	ESCALATOR 4	-
209	ESCALATOR 5	-
210	STAFF WASHROOM FEMALE	10
211	STAFF WASHROOM MALE	10
212	ELEVATOR 3	-
213	RETAIL	40
214	VALVE ROOM	10
215	A.C. SWITCHBOARD RM.	145
216	A.C. SWITCHGEAR RM.	85
217	EMERGENCY POWER RM.	15
218	COMM. EQUIPMENT RM.	68
219	JANITOR CLOSET	4.8
220	JANITOR CHANGE RM.	4.8
221	STORAGE	20
222	SMART CARD POWER /COMM.	12
223	STORAGE	10
224	FUTURE ELEVATOR 4	-
225	SUMP ROOM	10
226	ELEVATING DEVICE STORAGE	10
227	TELEPHONE EQUIPMENT RM.	4.5
228	ESCALATOR 6	-
229	ESCALATOR 7	-
230	AUTOMATIC FARE LINE	-
231	BRICK LAYER'S ROOM	12
232	PLUMBER'S MAINT. ROOM	12
233	SUBWAY VENTILATION RM.	500
234	FIRE FIGHTERS ACCESS	-
235	FIRE FIGHTERS ACCESS	-
236	STAIR 3	-
237	STAIR 4	-
238	ELECTRICAL HIGH VOLTAGE RM.	70
239	ELECTRICAL DISTRIBUTION RM.	12
240	ELECTRICAL DISTRIBUTION RM.	12
241	MECHANICAL /HVAC RM.	TBD
242	ELEV./ESCALATOR MACH. RM.	30

LEGEND	
	ROAD
	ELEVATED ROAD
	PUBLIC AREA
	SERVICE ROOMS
	VERTICAL CIRCULATION
	RETAIL
	LANDSCAPE AREA
	NORMAL OPERATION EXIT WAY

CONCOURSE LEVEL PLAN 1
SCALE 1:500 008H

DRAWING No. SHEET No. FILE BLDG. REF. No.

REVISIONS	REVISIONS

CONCEPTUAL DESIGN
 NOT FOR CONSTRUCTION

Hatch Mott MacDonald
MRC McCormick Rankin Corporation
 A member of MMM GROUP

DRAWN _____
 CHECKED _____
 CORRECT _____
 SCALE 0 5 10 15 20m

YONGE SUBWAY EXTENSION
CUMMER STATION
 CONCOURSE LEVEL
 CENTRE PLATFORM

Plot Date: 8/26/2011

TORONTO TRANSIT COMMISSION
 ENGINEERING DEPARTMENT
 Dwg. No. **SK-A-008H** Sheet No. _____

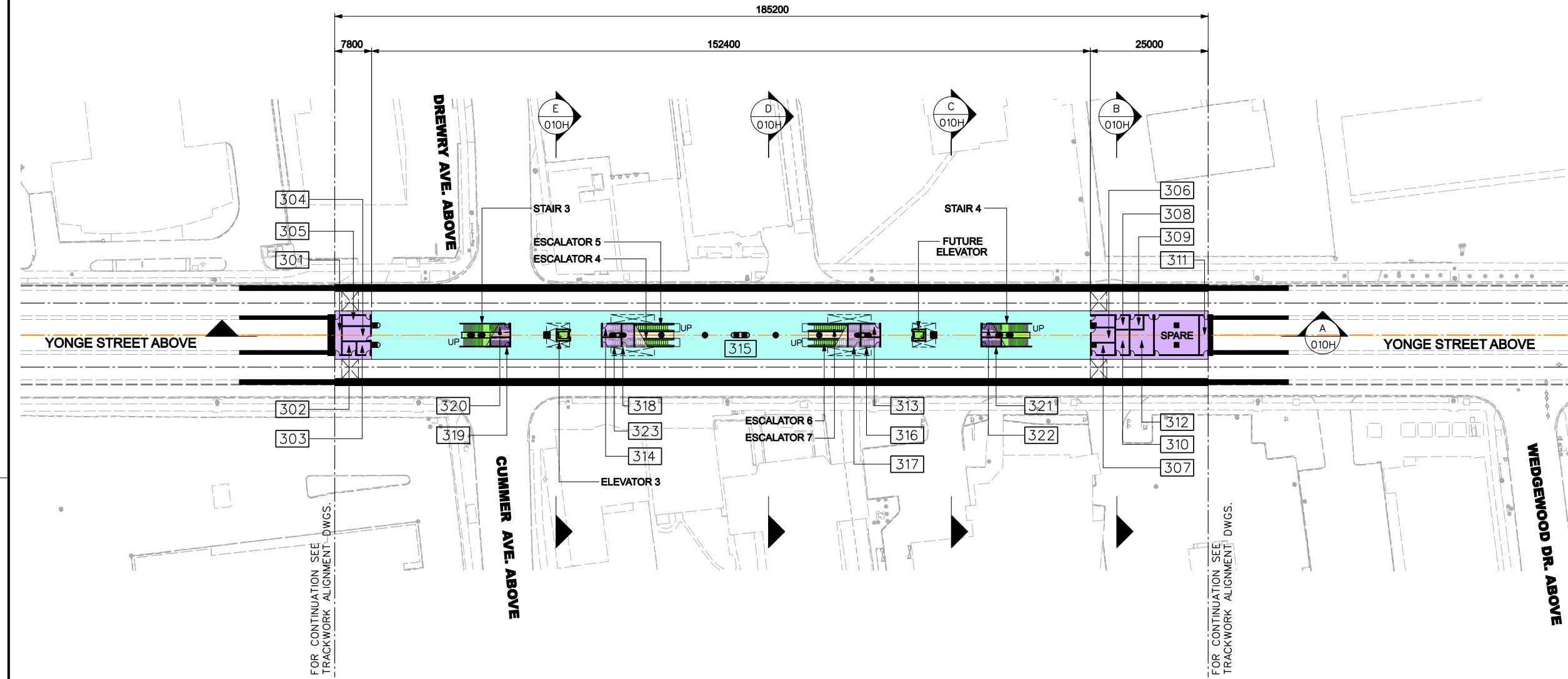
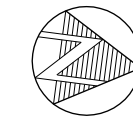

ROOM SCHEDULE LEGEND		
RM. No.	ROOM NAME	APPROX. RM. AREA
301	FIRE FIGHTERS ACCESS	12
302	POWER CABLE PULL RM	8
303	SYS. & COMM. CABLE PULL RM	8
304	TRACTION POWER ROOM	18
305	AUXILLARY ELECTRICAL RM.	12
306	AUXILLARY ELECTRICAL RM.	12
307	SUMP PUMP ROOM	10
308	SYS. & COMM. CABLE PULL RM	8
309	POWER CABLE PULL RM	8
310	P.E.D. ROOM (E.R.R.)	12
311	FIRE FIGHTERS ACCESS	15
312	SIGNAL POWER SUPPLY ROOM	25
313	ESCALATOR SERVICE ROOM	9
314	ESCALATOR SERVICE ROOM	9
315	SUBWAY PLATFORM	-
316	ESCALATOR STORAGE ROOM	7.5
317	JANITOR SERVICE ROOM	10
318	SUMP PUMP ROOM	10
319	ELEVATOR MACHINE ROOM	7.3
320	ELEVATOR HVAC ROOM	11
321	FUTURE ELEVATOR MACHINE RM.	7.3
322	FUTURE ELEVATOR HVAC RM.	11
323	ESCALATOR STORAGE ROOM	7.5

LEGEND	
	ROAD
	ELEVATED ROAD
	PUBLIC AREA
	SERVICE ROOMS
	VERTICAL CIRCULATION
	RETAIL
	LANDSCAPE AREA
	NORMAL OPERATION EXIT WAY

PLATFORM LEVEL PLAN 1
SCALE 1:500
009H

DRAWING No. SHEET No. FILE BLDG. REF. No.

REVISIONS	REVISIONS

CONCEPTUAL DESIGN
 NOT FOR CONSTRUCTION

DRAWN
CHECKED
CORRECT
SCALE	0 5 10 15 20m

YONGE SUBWAY EXTENSION
CUMMER STATION
 PLATFORM LEVEL
 CENTRE PLATFORM

Plot Date: 8/26/2011

TORONTO TRANSIT COMMISSION
ENGINEERING DEPARTMENT

Dwg. No. **SK-A-009H** Sheet No.

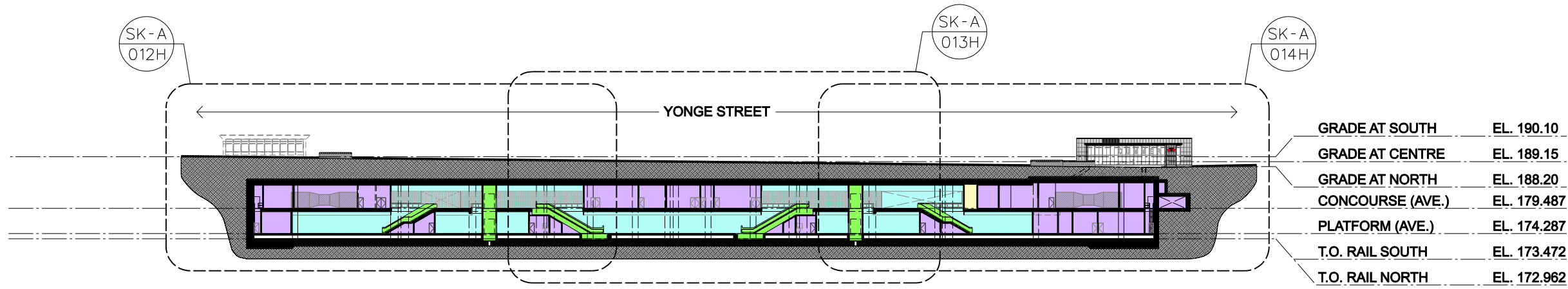

SECTION A-A
SCALE 1:500 LOOKING WEST SK-A-010H

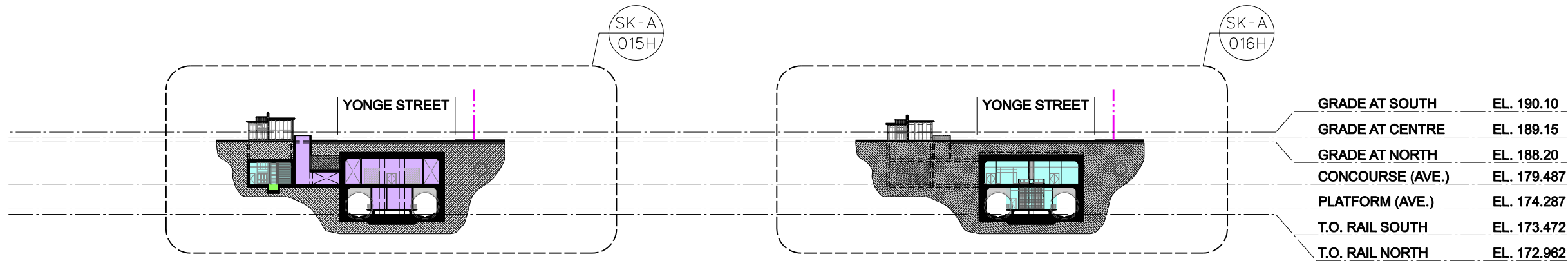

SECTION B-B
SCALE 1:500 LOOKING NORTH SK-A-010H

SECTION C-C
SCALE 1:500 LOOKING NORTH SK-A-010H

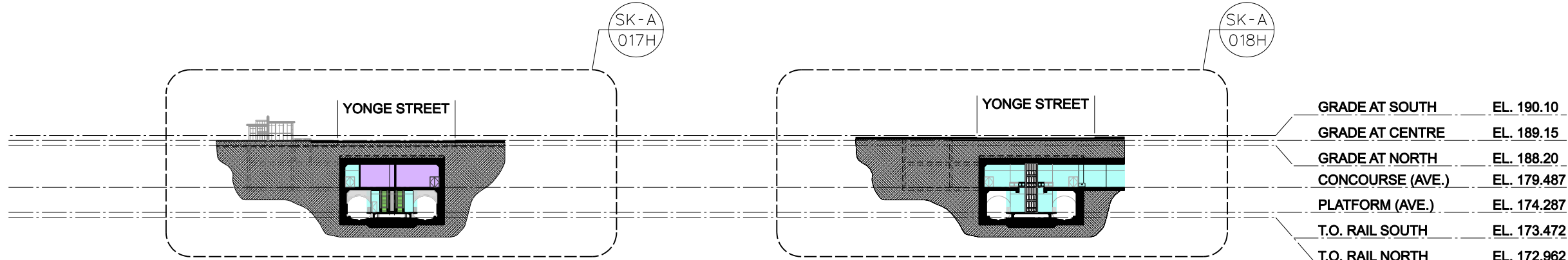

SECTION D-D
SCALE 1:500 LOOKING NORTH SK-A-010H

SECTION E-E
SCALE 1:500 LOOKING NORTH SK-A-010H

LEGEND

	ROAD
	ELEVATED ROAD
	PUBLIC AREA
	SERVICE ROOMS
	VERTICAL CIRCULATION
	RETAIL
	LANDSCAPE AREA
	NORMAL OPERATION EXIT WAY

BLDG. REF. No. FILE SHEET No.

REVISIONS	REVISIONS

CONCEPTUAL DESIGN
NOT FOR CONSTRUCTION

Hatch Mott MacDonald
MRC McCormick Rankin Corporation
A member of **MMM GROUP**

DRAWN: _____
CHECKED: _____
CORRECT: _____
SCALE:

YONGE SUBWAY EXTENSION
CUMMER STATION
OVERALL CROSS SECTIONS

Plot Date: 8/26/2011

TORONTO TRANSIT COMMISSION
ENGINEERING DEPARTMENT
Dwg. No. **SK-A-010H** Sheet No. _____

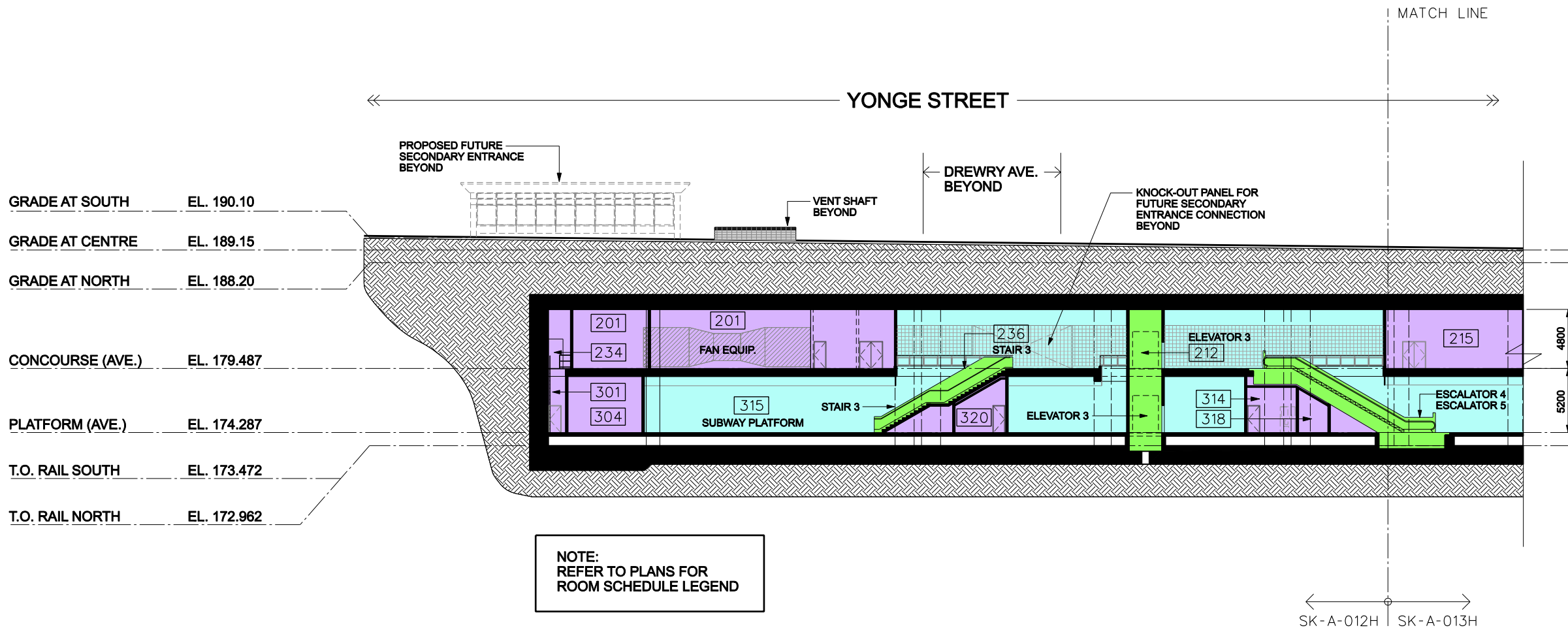

SECTION A-A - SOUTH END
SCALE 1:200 LOOKING WEST A
SK-A-012H

- LEGEND**
- ROAD
 - ELEVATED ROAD
 - PUBLIC AREA
 - SERVICE ROOMS
 - VERTICAL CIRCULATION
 - RETAIL
 - LANDSCAPE AREA
 - NORMAL OPERATION EXIT WAY

BLDG. REF. No. FILE SHEET No. DRAWING No.

REVISIONS	REVISIONS

CONCEPTUAL DESIGN
 NOT FOR CONSTRUCTION

DRAWN _____
 CHECKED _____
 CORRECT _____
 SCALE:

YONGE SUBWAY EXTENSION
CUMMER STATION
 PART CROSS SECTIONS

Plot Date: 8/26/2011

 TORONTO TRANSIT COMMISSION
 ENGINEERING DEPARTMENT
 Dwg. No. **SK-A-012H** Sheet No. _____

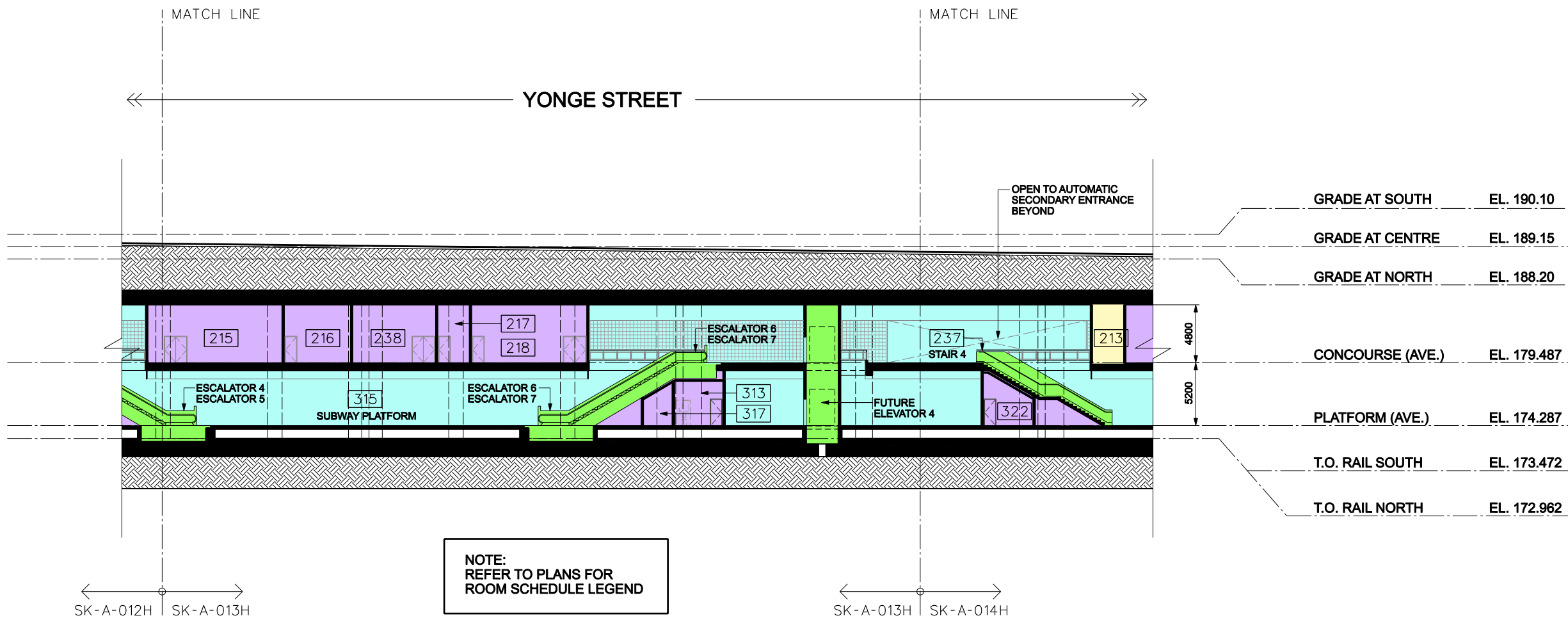

NOTE:
REFER TO PLANS FOR
ROOM SCHEDULE LEGEND

GRADE AT SOUTH	EL. 190.10
GRADE AT CENTRE	EL. 189.15
GRADE AT NORTH	EL. 188.20
CONCOURSE (AVE.)	EL. 179.487
PLATFORM (AVE.)	EL. 174.287
T.O. RAIL SOUTH	EL. 173.472
T.O. RAIL NORTH	EL. 172.962

SECTION A-A - CENTRE
SCALE 1:200
LOOKING WEST
A
SK-A-013H

LEGEND

	ROAD
	ELEVATED ROAD
	PUBLIC AREA
	SERVICE ROOMS
	VERTICAL CIRCULATION
	RETAIL
	LANDSCAPE AREA
	NORMAL OPERATION EXIT WAY

BLDG. REF. No. FILE SHEET No. DRAWING No.

REVISIONS	REVISIONS

CONCEPTUAL DESIGN
NOT FOR CONSTRUCTION

DRAWN _____
CHECKED _____
CORRECT _____

SCALE
0 1 2 3 4 5 8m

YONGE SUBWAY EXTENSION
CUMMER STATION
PART CROSS SECTIONS

Plot Date: 8/26/2011

TORONTO TRANSIT COMMISSION
ENGINEERING DEPARTMENT

Dwg. No. SK-A-013H Sheet No. _____

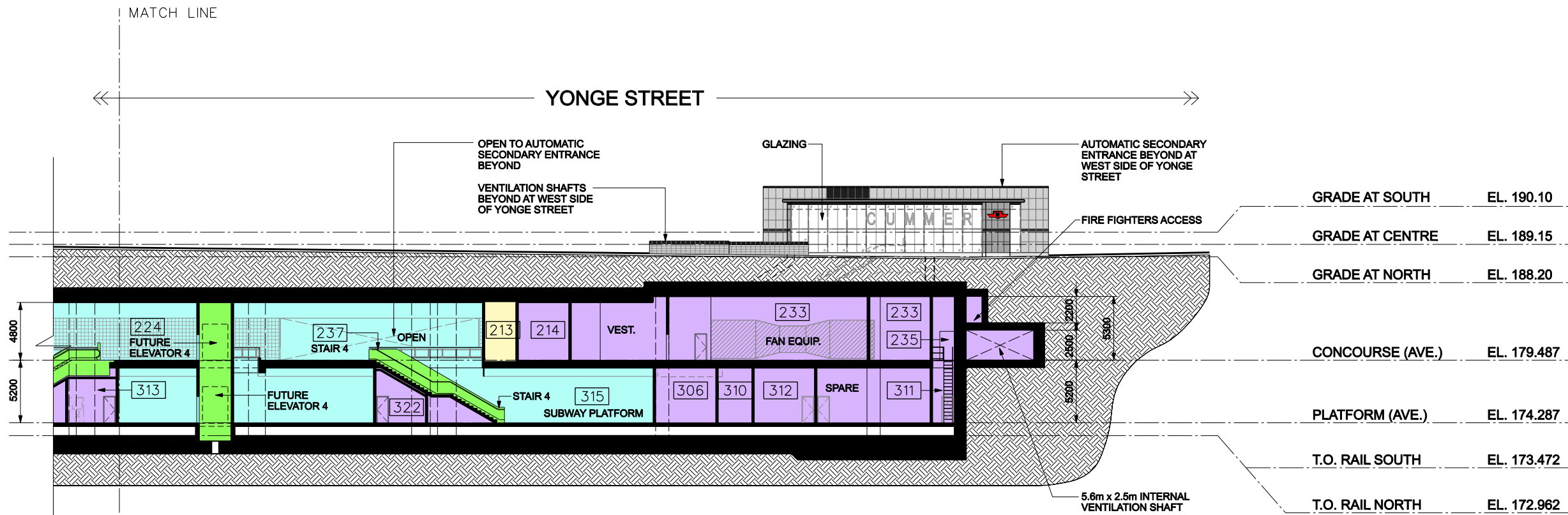

NOTE:
REFER TO PLANS FOR
ROOM SCHEDULE LEGEND

SECTION A-A - NORTH END
SCALE 1:200
LOOKING WEST

- LEGEND
- ROAD
 - ELEVATED ROAD
 - PUBLIC AREA
 - SERVICE ROOMS
 - VERTICAL CIRCULATION
 - RETAIL
 - LANDSCAPE AREA
 - NORMAL OPERATION EXIT WAY

BLDG. REF. No. FILE SHEET No. DRAWING No.

REVISIONS	REVISIONS

CONCEPTUAL DESIGN
 NOT FOR CONSTRUCTION

DRAWN _____
 CHECKED _____
 CORRECT _____
 SCALE: 0 1 2 3 4 5 6m

YONGE SUBWAY EXTENSION
CUMMER STATION
 PART CROSS SECTIONS

Plot Date: 8/26/2011

 TORONTO TRANSIT COMMISSION
 ENGINEERING DEPARTMENT
 Dwg. No. **SK-A-014H** Sheet No.

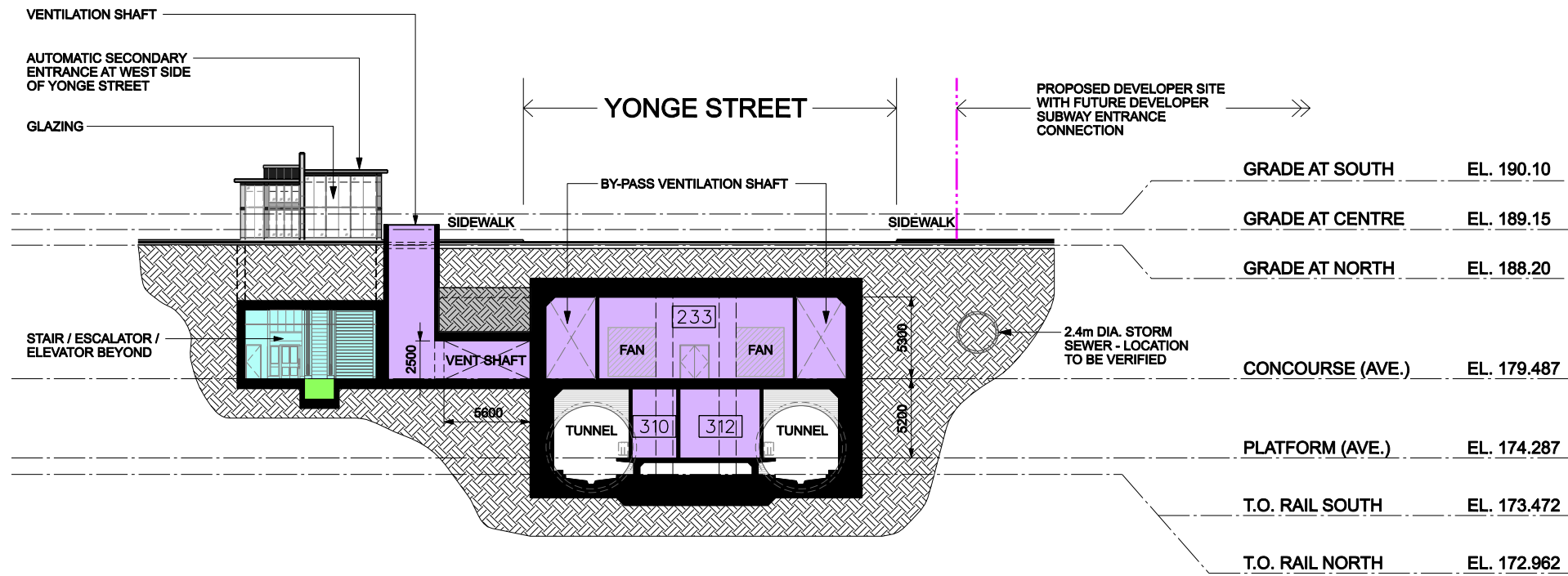

NOTE:
REFER TO PLANS FOR
ROOM SCHEDULE LEGEND

SECTION B-B
SCALE 1:200 LOOKING NORTH A SK-A-015H

- LEGEND**
- ROAD
 - ELEVATED ROAD
 - PUBLIC AREA
 - SERVICE ROOMS
 - VERTICAL CIRCULATION
 - RETAIL
 - LANDSCAPE AREA
 - NORMAL OPERATION EXIT WAY

BLDG. REF. No. FILE SHEET No. DRAWING No.

REVISIONS	REVISIONS

CONCEPTUAL DESIGN
 NOT FOR CONSTRUCTION

DRAWN _____
 CHECKED _____
 CORRECT _____
 SCALE: 5m

YONGE SUBWAY EXTENSION
CUMMER STATION
 PART CROSS SECTIONS

Plot Date: 8/26/2011

 TORONTO TRANSIT COMMISSION
 ENGINEERING DEPARTMENT
 Dwg. No. **SK-A-015H** Sheet No. _____

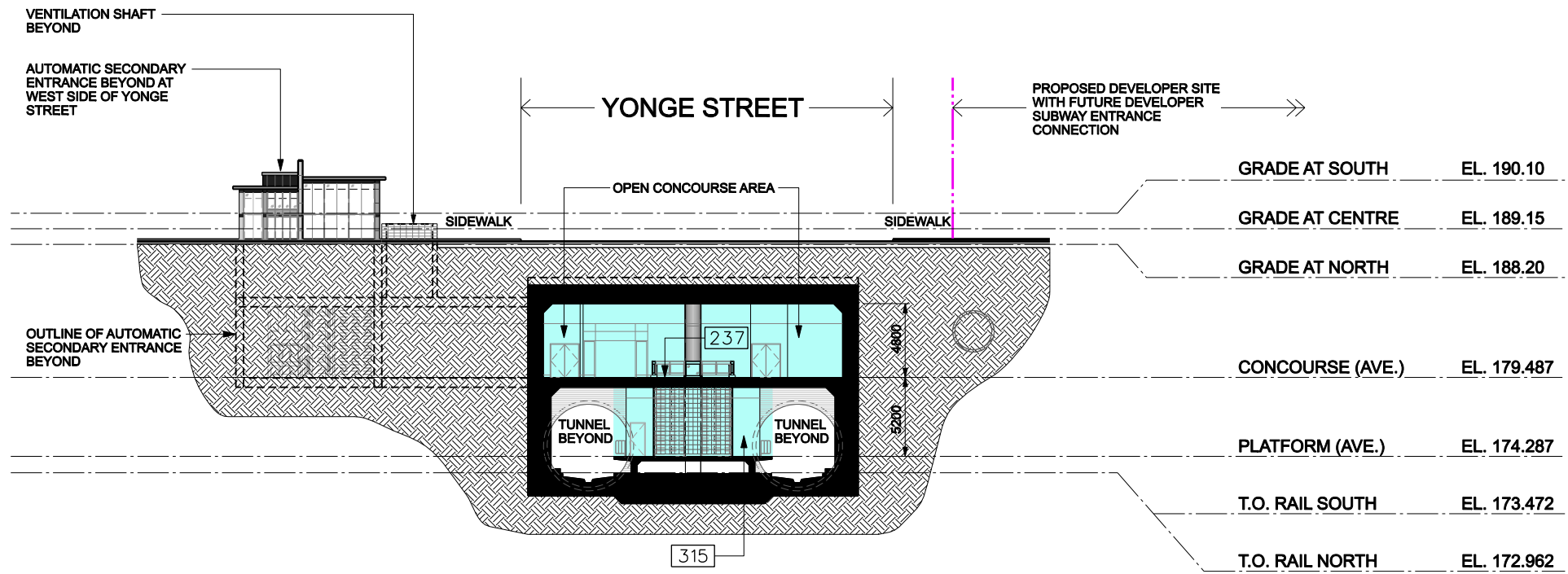

NOTE:
REFER TO PLANS FOR
ROOM SCHEDULE LEGEND

SECTION C-C
SCALE 1:200
LOOKING NORTH
A
SK-A-016H

LEGEND

	ROAD
	ELEVATED ROAD
	PUBLIC AREA
	SERVICE ROOMS
	VERTICAL CIRCULATION
	RETAIL
	LANDSCAPE AREA
	NORMAL OPERATION EXIT WAY

BLDG. REF. No.
FILE
SHEET No.
DRAWING No.

REVISIONS	REVISIONS

CONCEPTUAL DESIGN
NOT FOR CONSTRUCTION

Hatch Mott MacDonald
McCORMICK RANKIN CORPORATION
A member of MMM GROUP

DRAWN _____
CHECKED _____
CORRECT _____
SCALE
0 1 2 3 4 5 8m

YONGE SUBWAY EXTENSION
CUMMER STATION
PART CROSS SECTIONS

Plot Date: 8/26/2011
TORONTO TRANSIT COMMISSION
ENGINEERING DEPARTMENT
Dwg. No. SK-A-016H
Sheet No.

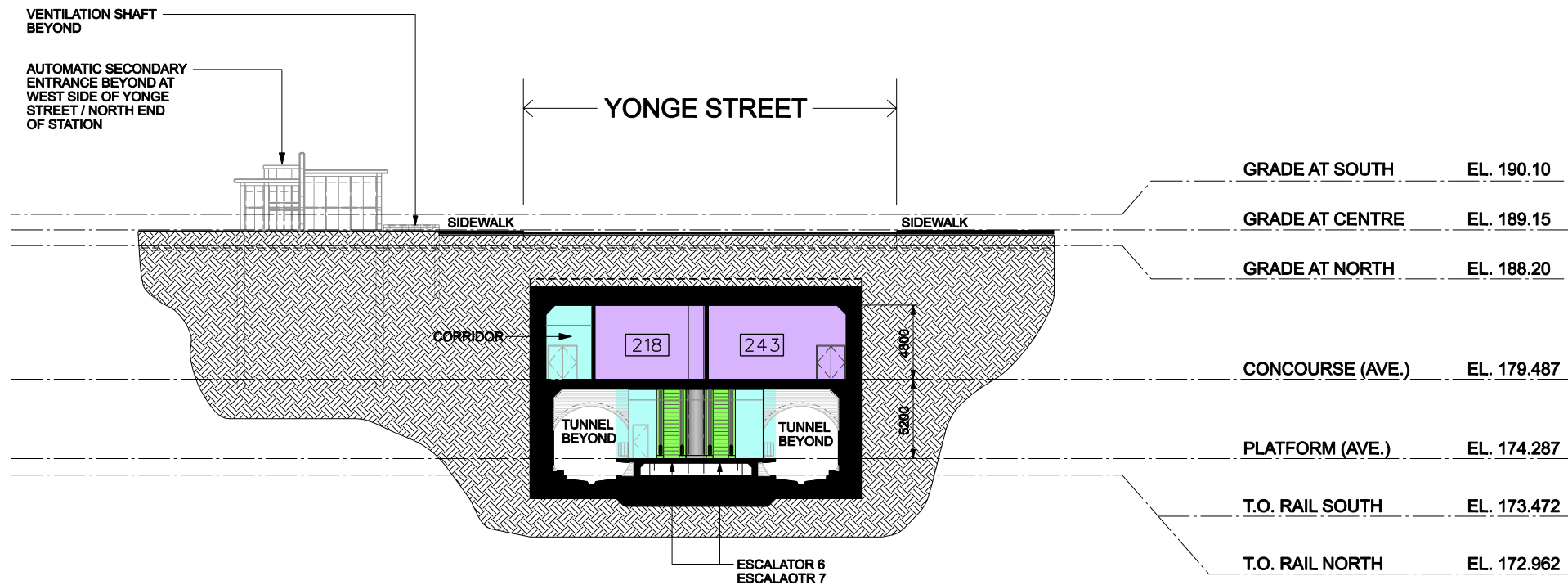

NOTE:
REFER TO PLANS FOR
ROOM SCHEDULE LEGEND

SECTION D-D
SCALE 1:200 LOOKING NORTH A SK-A-017H

- LEGEND
- ROAD
 - ELEVATED ROAD
 - PUBLIC AREA
 - SERVICE ROOMS
 - VERTICAL CIRCULATION
 - RETAIL
 - LANDSCAPE AREA
 - NORMAL OPERATION EXIT WAY

BLDG. REF. No.
FILE
SHEET No.
DRAWING No.

REVISIONS	REVISIONS

CONCEPTUAL DESIGN
 NOT FOR CONSTRUCTION

DRAWN _____
 CHECKED _____
 CORRECT _____
 SCALE: 5m

YONGE SUBWAY EXTENSION
CUMMER STATION
 PART CROSS SECTIONS

Plot Date: 8/26/2011

 TORONTO TRANSIT COMMISSION
 ENGINEERING DEPARTMENT
 Dwg. No. **SK-A-017H** Sheet No. _____

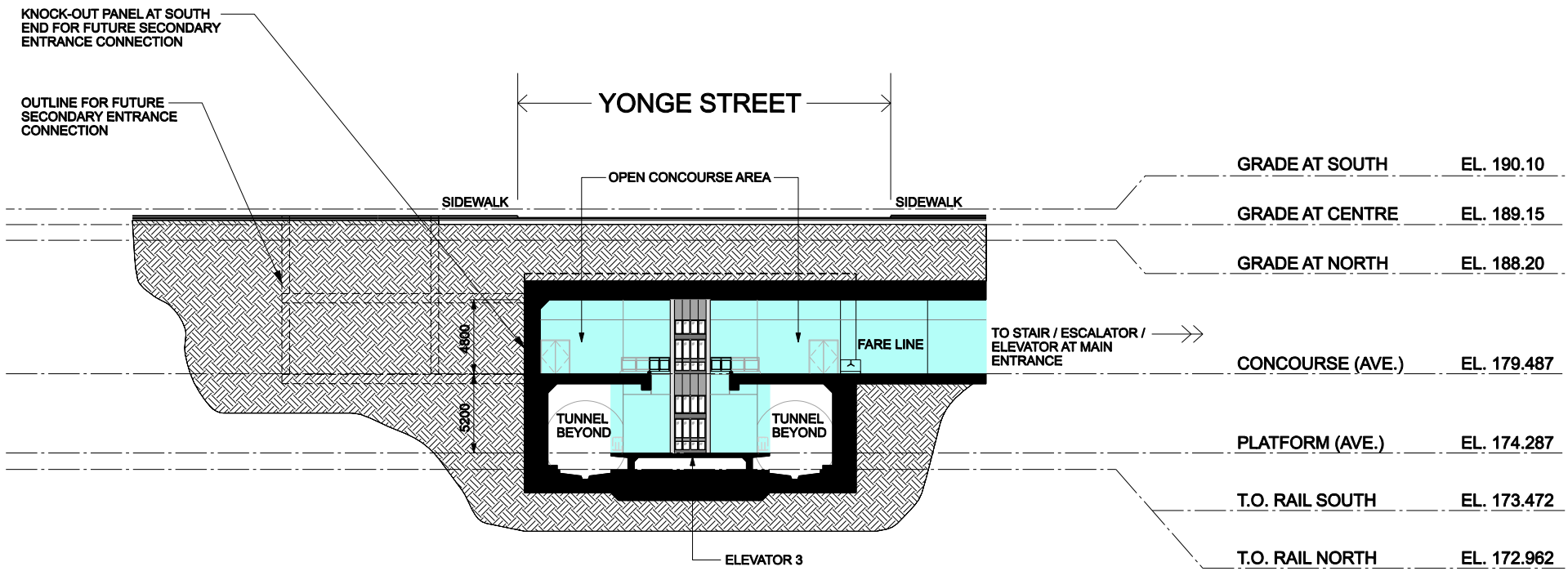

NOTE:
REFER TO PLANS FOR
ROOM SCHEDULE LEGEND

SECTION E-E
SCALE 1:200
LOOKING NORTH
A
SK-A-018H

- LEGEND
- ROAD
 - ELEVATED ROAD
 - PUBLIC AREA
 - SERVICE ROOMS
 - VERTICAL CIRCULATION
 - RETAIL
 - LANDSCAPE AREA
 - NORMAL OPERATION EXIT WAY

BLDG. REF. No.
FILE
SHEET No.
DRAWING No.

REVISIONS	REVISIONS
△	△
△	△
△	△

CONCEPTUAL DESIGN
 NOT FOR CONSTRUCTION

DRAWN _____
 CHECKED _____
 CORRECT _____
 SCALE

YONGE SUBWAY EXTENSION
CUMMER STATION
 PART CROSS SECTIONS

Plot Date: 8/26/2011

 TORONTO TRANSIT COMMISSION
 ENGINEERING DEPARTMENT
 Dwg. No. **SK-A-018H** Sheet No. _____

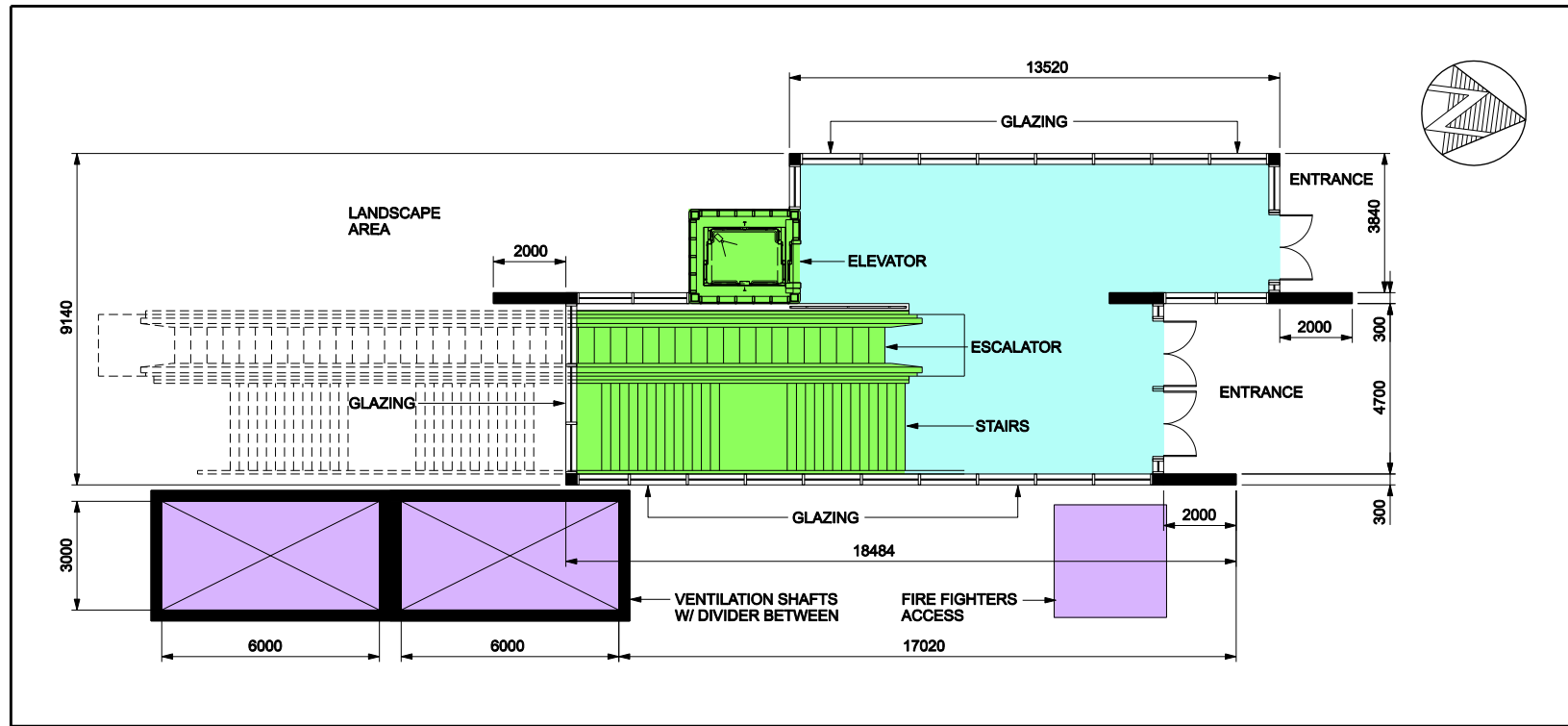

AUTOMATIC ENTRANCE PLAN (2)
SCALE 1:100 (019H)



MAIN ENTRANCE PLAN (1)
SCALE 1:100 (019H)

BLDG. REF. No.

FILE

SHEET No.

DRAWING No.

REVISIONS	REVISIONS

CONCEPTUAL DESIGN
NOT FOR CONSTRUCTION

Hatch Mott MacDonald

MRC McCORMICK RANKIN CORPORATION
A member of **MMM GROUP**

DRAWN _____
CHECKED _____
CORRECT _____

SCALE
0 1 2 3 4m

YONGE SUBWAY EXTENSION

CUMMER STATION
STREET LEVEL - ENTRANCES

Plot Date: 8/26/2011

TORONTO TRANSIT COMMISSION
ENGINEERING DEPARTMENT

Dwg. No. **SK-A-019H** Sheet No. _____

8. STEELES STATION

The Steeles Station is located beneath Yonge Street at Steeles Avenue. The subway station provides a high potential for land use intensification and numerous connections between bus and subway movements. Several significant changes have been implemented to the station design from the station layout provided during the TPAP. The size of the bus terminal has been reduced, the entrance portal from Yonge Street has been eliminated and significant improvements to passenger circulation have been designed.

A 16-bay underground bus terminal will be constructed below Steeles Avenue on the west side of Yonge Street with direct station access for passengers from the bus terminal to the subway platform. Two entrances to the station will be provided from the southwest and northeast corners of the intersection. Knock-out panels will be provided for future subway entrances at the other two corners (northwest and southeast). There will be a substation east of Yonge Street on the south side of Steeles Avenue. There will also be an pedestrian entrance at the west end of the Steeles Bus Terminal, located within the median of Steeles Avenue.

The preferred design concept now includes a new concourse level which allows free body transfers under the Yonge/Steeles intersection and future developer connections as well as addressing bus to subway transfer issues with the TPAP option. This level was created by lowering the bus terminal and reducing the cover over top of the concourse.

8.1 Passenger Transfer Movements

The passenger transfer movements at Steeles Station were estimated based on the passenger demand forecast analysis described in Section 2 and Appendix 'A' of this report. A breakdown of the forecast 2031 AM peak hour transfer movements by mode and by direction can be found in **Table 8-1**.

Table 8-1: Estimated Passenger Transfer Movements at Steeles Station (2031)

TRANSFERS		OUT OF STATION							TOTAL
INTO STATION	DIR	SUBWAY		TTC BUS		YRT		WALK OUT	
		NB	SB	EB	WB	EB	WB		
SUBWAY	NB	0	0	470	400	180	110	300	1460
	SB	0	0	120	100	10	0	30	260
TTC BUS	EB	40	780	60	0	20	0	80	980
	WB	30	1260	0	240	0	10	50	1590
YRT	EB	0	700	10	0	20	0	30	760
	WB	0	190	0	10	0	0	0	200
WALK IN		20	270	30	50	0	0	0	370
TOTAL		90	3200	690	800	230	120	490	5620

Transfer movements at Steeles Station are predominantly between the subway and connecting TTC and YRT routes. Of the total 5,620 AM peak hour passenger movements projected at Steeles Station, about 78% (4,390) are between the subway and connecting bus routes while 11% (620) are between the subway and walk-in/out. Note that the City of Toronto is initiating a review of the area to the south of Steeles Avenue which will likely result in increased density and therefore more walk-in ridership potential. These passenger

movements are significantly improved with the current station layout as several paths are now provided rather than the option shown in the TPAP where only one path was provided between the bus terminal and the subway platform.

Passenger flow diagrams prepared for Steeles Station can be found in Appendix 'E' of this report.

8.2 Bus Terminal

The TPAP preferred concept included a bus terminal with 25 bus bays under Steeles Avenue to accommodate the large number of TTC and YRT bus routes that will be serving the station. There would be two portals on Steeles Avenue – one on each side of Yonge Street – and one portal on Yonge Street north of Steeles Avenue for TTC and YRT buses to access the underground terminal. However, through consultation with YRT and TTC staff during the Conceptual Design Study, the required number of bus bays at the terminal has been reduced from 25 to 16. Specifically, the number of bus bays required to serve YRT has been reduced from 12 to five by relocating YRT 2 MILLIKEN, 5 CLARK, 23 THORNHILL WOODS, and 77 HWY 7-CENTRE from Steeles Station to Clark Station, as well as by optimizing the way bus bays are allocated to YRT. An adjustment in the way bus bays are allocated to TTC routes has also reduced the number of TTC bus bays from 13 to 11. The proposed bus bay allocation for YRT and TTC routes are summarized in **Tables 8-2 and 8-3** respectively.

As with the TPAP preferred concept, buses operating on Steeles Avenue will enter and exit the terminal via two portals located in the median of Steeles Avenue: one to the east of the Yonge Street intersection, and one west of Yonge Street, just east of Tangreen Court. Note that these portals, and the proposed landscaped median, will limit vehicle access into the mall from the westbound lanes of Steeles Avenue, and the reverse movement from the Mall westbound. Some means of allowing these traffic movements must be considered in the next phase of design. To minimize the impact of the portals on the existing road network, the proposed bus ramps have been designed at 7.5% (max.). This requirement is above the TTC maximum gradient and would require a design variance and the installation of in-slab heating to provide better traction for buses.

Unlike the TPAP preferred concept, there is no portal on Yonge Street north of the Steeles intersection as all but one of the YRT routes operating on Yonge Street will terminate at Clark Station. The remaining YRT 99 YONGE will use local roads to layover and turnaround at Steeles Station.

Table 8-2: Proposed YRT Bus Bay Allocation at Steeles Station

Route	Type	Future Peak Headway (minutes' seconds")	No. of Bus Bays
88 Bathurst	Terminating	10' 00"	1
91 Bayview	Terminating	10' 00"	1
99 Yonge	Terminating	10' 00"	1
	Mobility Plus		Use least busiest bay
	Future Service Growth		1
	Unload Only		1
	TOTAL		5

Table 8-3: Proposed TTC Bus Bay Allocation at Steeles Station

Route	Type	Future Peak Headway (minutes' seconds")	No. of Bus Bays
7 Bathurst	Terminating	5' 30"	1
11 Bayview	Terminating	8' 00"	1 (Shared)
98 Willowdale	Terminating	20' 00"	
53 Steeles East	Terminating	2' 30"	2
60 Steeles West	Terminating	2' 50"	2
97B Yonge	Terminating	20' 00"	1 (Shared)
98A Senlac	Terminating	20' 00"	
		Wheel-Trans	Use least busiest bay
		Future Service Growth	2
		Unload Only	2
		TOTAL	11

During the study, consultation has taken place with Centrepont Mall regarding opportunities for placement of the bus terminal on their property which would eliminate the significant amount of underground work, property acquisition for road widening and the bus portals along Steeles Avenue. Throughout the consultation, several options were discussed however there was no resolution at this stage to confirm whether there was a viable option for the relocation of the bus terminal. Throughout the next stages of the design, additional consultation with Centrepont should continue to explore opportunities for a bus terminal on their property.

8.3 Station Entrances

Three fully-accessible entrance pavilions will be built on opening day; one on the northeast corner, and one on the southwest corner of the Yonge Street and Steeles Avenue intersection, and one in the median on Steeles Avenue West. The two entrance pavilions at the intersection of Yonge and Steeles will be designed so they can be subsumed into future developments if the developer chooses, yet be aesthetically pleasing and robust enough to remain free-standing if required. The bus terminal entrance in the median of Steeles Avenue West will have stairs and an elevator, and will be designed to be permanent.

Locations have been shown for future entrances on the northwest and southeast quadrants of the Yonge Street and Steeles Avenue intersection that can be built as developer connections. Due to the location of the collector's booth and fare line, all four entrances allow free pedestrian movement below grade to all quadrants of the Steeles/Yonge intersection, creating the opportunity for the concourse to become part of an underground urban pedestrian network similar to the downtown PATH.

The provision for knockout panels for the two future entrances has been provided from the concourse. Both connections are free access, but will require the developer to provide stairs, elevator, escalators, and signage within their development that must remain accessible through the same hours as the TTC station.

Both opening day Entrances are fully accessible, each including an elevator, two escalators, and stairs.

The concept also includes a secondary entrance in the median on Steeles Avenue west of Yonge Street to provide a direct connection between the YRT portion of the bus terminal and the surface without crossing the TTC fareline. This entrance could be reduced to a Station Emergency Exit Building (SEEB), or a full time exit, if a fare integration policy was in place between YRT and TTC.

8.4 Street Level

The traction power substation is a stand-alone facility located at grade on the south side of Steeles Avenue, east of Yonge Street. Additional effort will be needed on the specific location and urban design of this facility in the next phase of design in order to maximise the potential for adjacent TOD.

Emergency ventilation shafts are located on both sides of Yonge Street to the north of Steeles Avenue just south of the intersection with Highland Park Boulevard; and on both sides of Yonge Street south of Steeles Avenue, just to the north of Nipigon Avenue.

Note that additional station ventilation shafts are required for normal exhaust and makeup air to staffed spaces below grade, and will be sized and located in the next phase of design. Additional ventilation shafts will also be required to clear exhaust fumes from bus operations below ground and will be sized and located in the next phase of design (refer also to **Section 9.2.6**). Both of these will require additional property and easements for future development.

Two Fire Fighter's Access shafts are provided: one located on the west side of Yonge Street opposite Highland Park Boulevard, and one on the northeast corner of Yonge and Nipigon Avenue.

A Station Emergency Exit Building (SEEB) is required, located on the west side of Yonge Street opposite Highland Park Boulevard.

We are proposing a landscaped median be placed over the bus terminal under Steeles Avenue both west and east of Yonge Street. This serves a number of functions:

- Improved vehicular traffic flow by reducing turning movements;
- Improved pedestrian safety by deterring jaywalking;
- Increased area for triage in station emergency with evacuation from the Bus Terminal Entrance located in median;
- Opportunity for upgrade to urban design of street aesthetic using the median;
- Opportunity for skylights or "light tubes" to allow natural light to penetrate down to bus platform level

Additional ventilation shafts will be required to clear exhaust fumes from bus operations below ground. The medians within Steeles Avenue are a good location for these additional vents which will be sized and located in the next phase of design.

8.5 Concourse Level

Entering the concourse from either of the two Entrance pavilions, patrons move into a circular space that links and unites pedestrian flows to all parts of the facility. Surrounding this space are opportunities for retail within the unpaid area of pedestrian circulation. To the east are views down to the bus laneways leading to the east portal. To the center are views down to the bus terminal rotunda circulation space. To the west is a collector's booth and low fare array providing access to both bus terminal and subway station. To the north is a second fare array providing access directly to the subway platform; note this array could be designed as an automatic fare array with Easier Access Portal Unit (EAPU).

Moving past the Collector's Booth and through a low gate fare array to the west leads to an enclosed concourse with views down to the bus platform below, with two escalators, a double set of stairs and an elevator down.

Moving through the north fare array, leads to a concourse with two escalators and an elevator providing direct access to the subway platform.

The majority of the station utility rooms have been located at Concourse level.

8.6 Bus Terminal Level

The bus platform consists of a TTC fare-paid area and an YRT non-paid area, with a fareline running across the width of the platform separating the two areas.

Passengers from the concourse level using the escalators come down into the rotunda and from there have direct access to the subway platform via two stair/escalator combinations, or a centrally located elevator. They can also access the bus platform through a set of doors. A number of windows provide views of bus circulation around the rotunda. An opportunity also exists for additional windows to the north side of the bus circulation allowing views between bus circulation roadway and the subway platform.

Passengers from concourse level using the elevator have access directly to the bus platform. If they are transitioning to the subway platform they must enter the rotunda via the doors with barrier-free automatic actuators.

Passengers from concourse level using the stairs arrive at the center of the bus platform through a set of doors.

Passengers entering the station through the Bus Terminal Entrance arrive at the west end of the bus platform where the YRT buses are located. To access the TTC station, patrons pass through a high gate fare array (with an Easier Access Portal Unit) to the TTC bus platform, and from there can access the rest of the station.

Bus operations within the terminal will produce exhaust emissions that, if unventilated, will result in occupants being exposed to high concentrations of harmful gases. In order to reduce the concentration of these contaminants to acceptable levels it is necessary to introduce outside air to both dilute and remove the exhaust gases.

One option would be to supply fresh air to the terminal such that the contaminated air is forced out the portals. However, this scheme would tend to positively pressurize the terminal relative to the connecting spaces increasing the risk of exhaust gases entering the concourse and subway platform areas.

The preferred approach therefore is to exhaust air from the centre of the terminal such that fresh air is drawn in through the portals and contaminated air is exhausted to grade via a ventilation shaft located within the median strip.

It is anticipated that ventilation will be provided by two fans located within a fan room at bus concourse level, with each fan similar in capacity to one of the station ventilation fans.

Emergency ventilation fans for the subway station box are located at the bus terminal level, with two fan assemblies located at each end of the station box. These service rooms are accessible to TTC personnel from either above or below using service stairs.

Additional ventilation will be required at the bus terminal to remove fumes from bus operations. The fan sizes, room requirements, and intake and exhaust vent locations will be determined in the next phase of design.

8.7 Platform Level

The center platform is 152.4m long to accommodate the current six-car train consists operated by TTC. As this is the standard length for platforms in the TTC subway system it is assumed that future ATC (Automatic Train Control) train operation will allow the operation of longer trains, including the possibility of seven-car consists.

Patrons move between concourse and platform using four escalators, two sets of stairs, and two elevators. Due to the vertical run from Concourse level, a two-storey space is provided at the north end of the platform, with the possibility of additional views into the bus circulation around the rotunda.

As the stairs and escalators do not provide sufficient vertical circulation under emergency conditions, an SEEB is provided at the north end of the platform. This will required dynamic signage similar to that installed on the Sheppard Subway ("EXIT when flashing"), triggered by activation of the emergency ventilation system.

A TTC service stair is provided at the south end of the station to provide staff access to service rooms above.

8.8 Roads

As a result of having bus portals on Steeles Avenue, the road needs to be widened to maintain the same number of traffic lanes as there is today. An apartment building on the north side of Steeles Avenue constrains the ability to widen the road to the north.

Additional topographic survey work was conducted to accurately locate the underground parking garage. It extends to the south limit of their property. Discussions took place with City of Toronto staff and they noted that they would not construct a public road on top of the private parking garage.

To create sufficient space for the bus portals on Steeles Avenue, east of Yonge Street, the TPAP recommended widening the south side of Steeles Avenue between Yonge Street and Willowdale Avenue, resulting in a need to acquire 27 private properties along the frontage of the road in the City of Toronto. After further consideration during this study, this option continues to be the only viable option for adding the bus portals to Steeles Avenue.

8.9 Passenger Pick-Up/Drop-Off

The TPAP concept includes a passenger pick-up and drop-off facility in either the northeast or the northwest quadrant of the intersection. The facility is intended to be incorporated into any future Transit-Oriented Development in the area. Additional work on the facility needs to be included in the next stage of design.

8.10 Utilities and Relocation Strategy

The existing York Durham trunk sanitary sewer runs east west along Steeles Avenue and is not impacted by the subway station. The elevation of the bottom of the station has been set to not impact the sewer however some protection work would be undertaken during construction to ensure the structural integrity of the sanitary sewer is maintained.

There are no major utilities within the Yonge Steeles intersection that cannot be permanently or temporarily relocated to make space for the subway and bus stations. Preliminary relocation strategies have been developed and costs have been included within the estimate for this work.

8.11 Archaeological Assessment

The Stage 1 Archaeological Assessment carried out as part of the Yonge Subway Extension TPAP identified parcels within the station area with archaeological potential that may be impacted by the preferred locations of the planned passenger pick-up/drop-off facility at Steeles Station. As such, a Stage 2 Archaeological Assessment (Property Assessment) was carried out on these lands as part of the Conceptual Design assignment. In spite of a comprehensive test pit survey at 5 metre intervals, no archaeological resources were recovered on the subject lands. As such, these lands previously determined to have archaeological potential can be considered clear of archaeological concern, and no further archaeological assessment is required. Details on the Stage 2 Archaeological Assessment can be found in **Appendix 'D'** of this report.

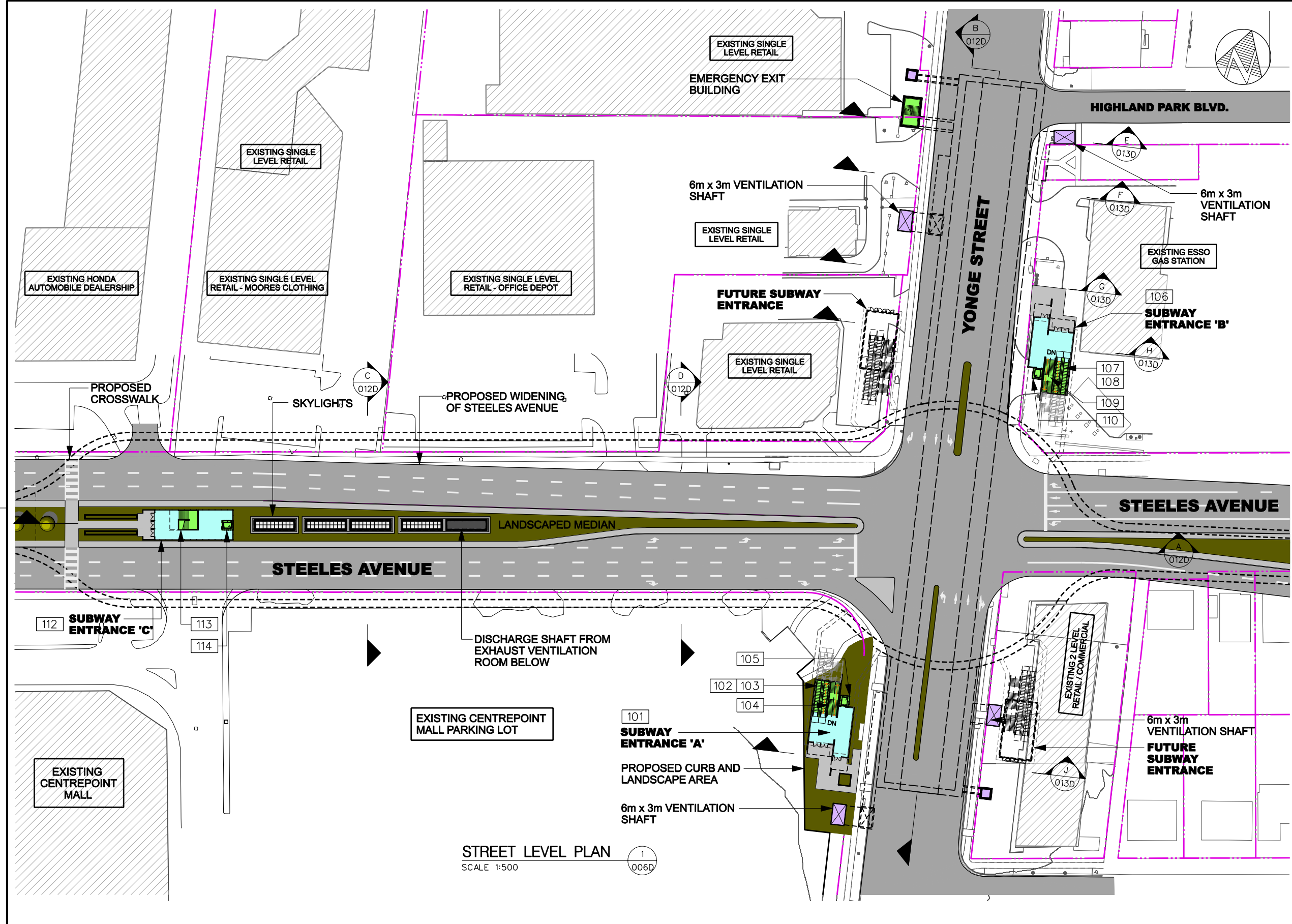

STREET LEVEL PLAN
SCALE 1:500

ROOM SCHEDULE LEGEND

RM. No.	ROOM NAME	APPROX. RM. AREA
101	SUBWAY ENTRANCE 'A'	95
102	ESCALATOR 1	-
103	ESCALATOR 2	-
104	STAIR 1	-
105	ELEVATOR 1	-
106	SUBWAY ENTRANCE 'B'	95
107	ESCALATOR 3	-
108	ESCALATOR 4	-
109	STAIR 2	-
110	ELEVATOR 2	-
111	ELECTRICAL SUBSTATION	918
112	SUBWAY ENTRANCE 'C'	120
113	STAIR 7	-
114	ELEVATOR 6	-

ROOM LEGEND - TYPICAL SUBSTATION

RM. No.	ROOM NAME	APPROX. RM. AREA
	HYDRO INCOMING LINE METERING	6
	SUBSTATION CONTROL ROOM	300
	CABLE ROOM	VARIES
	BATTERY ROOM	18
	WASHROOM	5
	STAFF LUNCH ROOM	10
	RECTIFIER ROOM	90
	TRANSFORMER YARD	300-350
	STORAGE	10
	MECHANICAL ROOM	TBD
	SERVICE ROAD /YARD	AS REQ'D
	SERVICE STAIR	* AS REQ'D
	FREIGHT LIFT /SHAFT	* AS REQ'D
	FREIGHT LIFT MACHINE RM.	* AS REQ'D

* AS REQUIRED PER INDIVIDUAL SUBSTATION

LEGEND

	ROAD
	ELEVATED ROAD
	PUBLIC AREA
	SERVICE ROOMS
	VERTICAL CIRCULATION
	RETAIL
	LANDSCAPE AREA
	NORMAL OPERATION EXIT WAY

DRAWING No. SHEET No. FILE BLDG. REF. No.

REVISIONS	REVISIONS

CONCEPTUAL DESIGN
NOT FOR CONSTRUCTION

Hatch Mott MacDonald

MRC McCORMICK RANKIN CORPORATION
A member of MMM GROUP

DRAWN _____
CHECKED _____
CORRECT _____
SCALE 0 5 10 15 20m

YONGE SUBWAY EXTENSION

STEELES STATION
STREET LEVEL

Plot Date: 8/27/2011

TORONTO TRANSIT COMMISSION
ENGINEERING DEPARTMENT

Dwg. No. **SK-A-006D** Sheet No. _____

LEGEND

- ROAD
- ELEVATED ROAD
- PUBLIC AREA
- SERVICE ROOMS
- VERTICAL CIRCULATION
- RETAIL
- LANDSCAPE AREA
- NORMAL OPERATION EXIT WAY

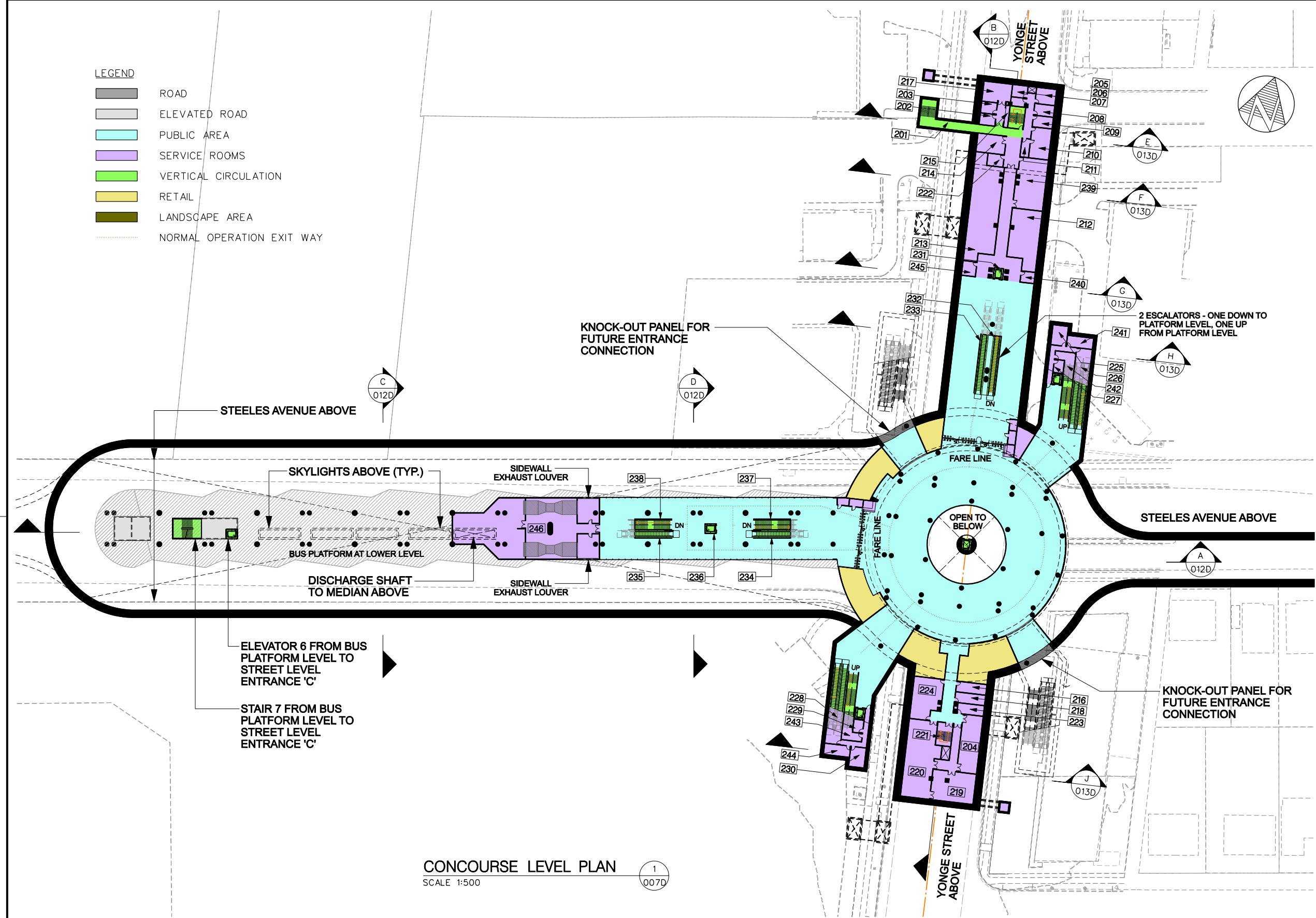

ROOM SCHEDULE LEGEND

RM. No.	ROOM NAME	APPROX. RM. AREA
201	EMERGENCY EXIT STAIR	24
202	SMART CARD DATA ROOM	12
203	COMMUNICATION MAINTENANCE ROOM	12
204	COMMUNICATION EQUIPMENT ROOM	60
205	JANITORS CLOSET	8
206	JANITORS CHANGE ROOM	4
207	JANITORS LUNCH ROOM	10
208	STAFF WASHROOM (M)	10
209	STAFF WASHROOM (F)	10
210	SPECIAL CONSTABLE SERVICES ROOM	35
211	INTERVIEW ROOM	8
212	UNASSIGNED	-
213	UNASSIGNED	-
214	TELEPHONE CLOSET	6
215	UNASSIGNED	-
216	VALVE ROOM	10
217	PLANT ELECT. MAINTENANCE ROOM	35
218	ELECTRICAL DISTRIBUTION RM.	16
219	AC SWITCHGEAR ROOM	80
220	AC SWITCHBOARD ROOM	145
221	SERVICE STAIR	24
222	ELECTRICAL DISTRIBUTION RM.	12
223	EMERGENCY POWER RM.	18
224	ELECTRICAL HIGH VOLTAGE RM.	70
225	AUXILLARY ELECTRICAL RM.	18
226	ESCALATOR SERVICE RM.	20
227	ELEVATOR MACHINE ROOM	7.5
228	ESCALATOR SERVICE RM.	20
229	ELEVATOR MACHINE ROOM	7.5
230	AUXILLARY ELECTRICAL RM.	18
231	ELEVATOR 3	-
232	ESCALATOR 5	-
233	ESCALATOR 6	-
234	ESCALATOR 7	-
235	ESCALATOR 8	-
236	ELEVATOR 4	-
237	STAIR 3	-
238	STAIR 4	-
239	MECHANICAL /HVAC ROOM	TBD
240	ELEVATOR MACHINE ROOM	8
241	STORAGE	17
242	ELEVATOR HVAC ROOM	20
243	ELEVATOR HVAC ROOM	20
244	STORAGE	17
245	ELEVATOR HVAC ROOM	12
246	EXHAUST VENTILATION ROOM	500

BLDG. REF. NO.

FILE

SHEET No.

DRAWING No.

REVISIONS	REVISIONS

CONCEPTUAL DESIGN
NOT FOR CONSTRUCTION



DRAWN _____
 CHECKED _____
 CORRECT _____
 SCALE 0 5 10 15 20m

YONGE SUBWAY EXTENSION
STEEL'S STATION
 CONCOURSE LEVEL

Plot Date: 8/27/2011

 TORONTO TRANSIT COMMISSION
 ENGINEERING DEPARTMENT
 Dwg. No. SK-A-007D Sheet No.

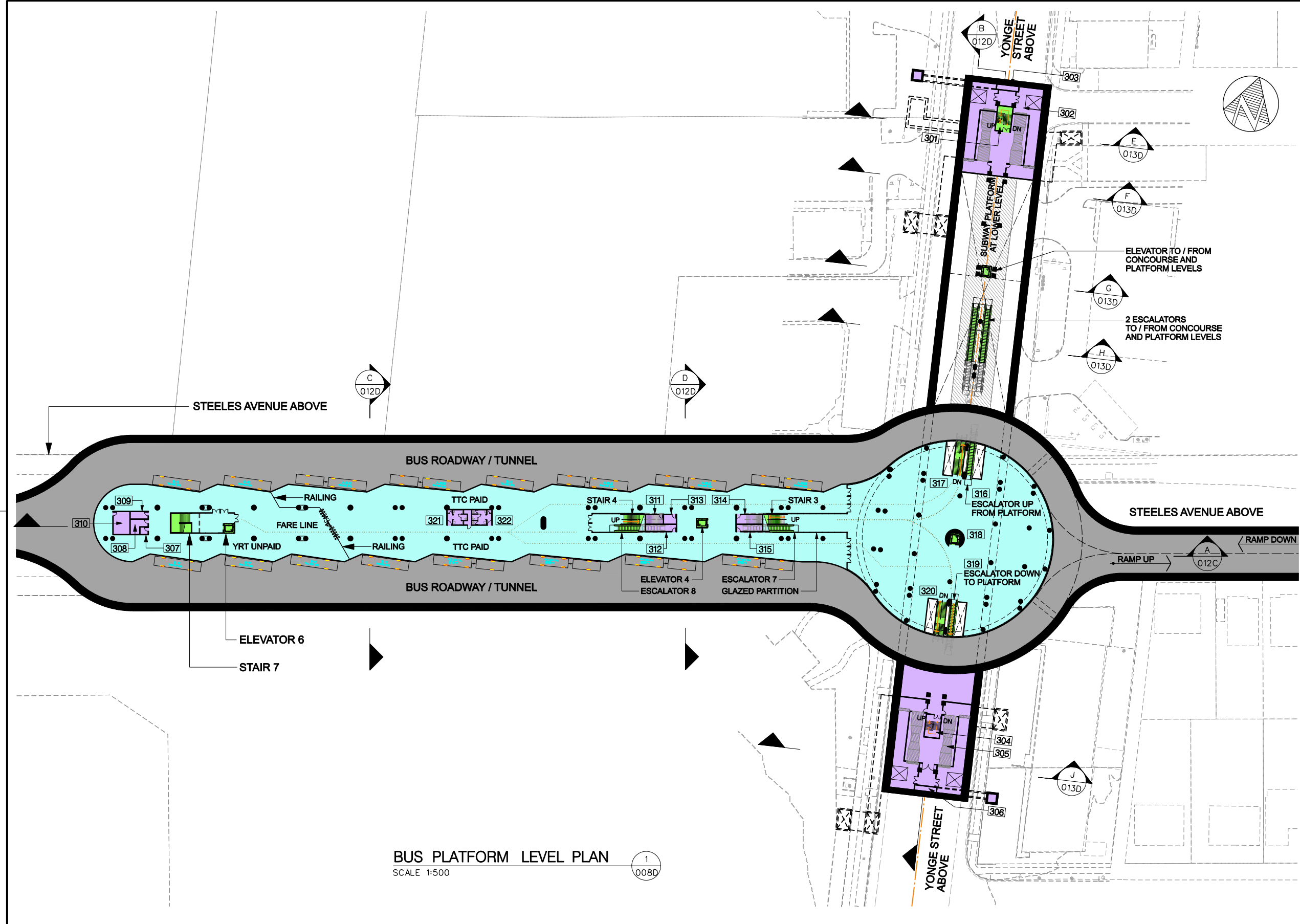

BUS PLATFORM LEVEL PLAN
SCALE 1:500

ROOM SCHEDULE LEGEND		
RM. No.	ROOM NAME	APPROX. RM. AREA
301	EMERGENCY EXIT STAIR	24
302	VENTILATION ROOM	440
303	FIREFIGHTERS ACCESS	12
304	SERVICE STAIR	24
305	VENTILATION ROOM	440
306	FIREFIGHTERS ACCESS	12
307	INSPECTORS ROOM	4
308	BUS OPERATOR LUNCH ROOM	14
309	BUS OPERATOR WASHROOM	10
310	ELECTRICAL / COMM. ROOM	24
311	ELEVATOR HVAC ROOM	10.5
312	ESCALATOR SERVICE ROOM	13
313	ELEVATOR MACHINE RM.	7.5
314	ELECTRICAL DISTRIBUTION RM.	15
315	ESCALATOR SERVICE ROOM	11
316	ESCALATOR 9	-
317	STAIR 5	-
318	ELEVATOR 5	-
319	ESCALATOR 10	-
320	STAIR 6	-
321	PUBLIC WASHROOM (M)	17
322	PUBLIC WASHROOM (F)	19

LEGEND	
	ROAD
	ELEVATED ROAD
	PUBLIC AREA
	SERVICE ROOMS
	VERTICAL CIRCULATION
	RETAIL
	LANDSCAPE AREA
	NORMAL OPERATION EXIT WAY

BLDG. REF. No. FILE SHEET No. DRAWING No.

REVISIONS	REVISIONS

CONCEPTUAL DESIGN
 NOT FOR CONSTRUCTION

Hatch Mott MacDonald
 McCormick Rankin Corporation
 A member of MMM GROUP

DRAWN _____
 CHECKED _____
 CORRECT _____
 SCALE 0 5 10 15 20m

YONGE SUBWAY EXTENSION
STEELES STATION
 BUS PLATFORM LEVEL

Plot Date: 8/27/2011

 TORONTO TRANSIT COMMISSION
 ENGINEERING DEPARTMENT
 Dwg. No. SK-A-008D Sheet No.

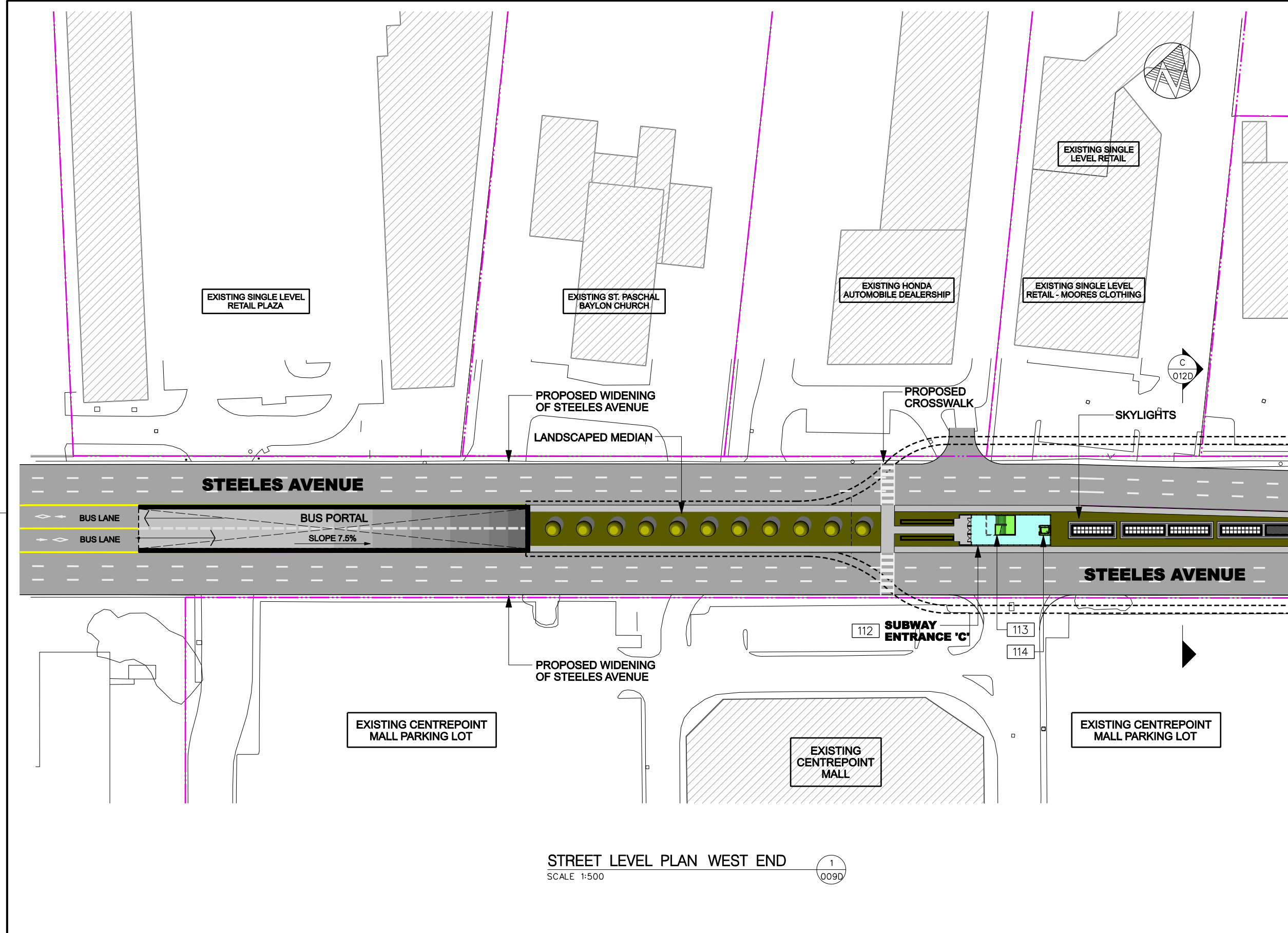

ROOM SCHEDULE LEGEND

RM. No.	ROOM NAME	APPROX. RM. AREA
112	SUBWAY ENTRANCE 'C'	120
113	STAIR 7	-
114	ELEVATOR 6	-

LEGEND

	ROAD
	ELEVATED ROAD
	PUBLIC AREA
	SERVICE ROOMS
	VERTICAL CIRCULATION
	RETAIL
	LANDSCAPE AREA
	NORMAL OPERATION EXIT WAY

STREET LEVEL PLAN WEST END
SCALE 1:500

BLDG. REF. No. FILE SHEET No. DRAWING No.

REVISIONS	REVISIONS

CONCEPTUAL DESIGN
 NOT FOR CONSTRUCTION

Hatch Mott MacDonald
 MRC McCormick Rankin Corporation
A member of MMM GROUP

DRAWN: _____
 CHECKED: _____
 CORRECT: _____
 SCALE:

YONGE SUBWAY EXTENSION
STEELES STATION
 STREET LEVEL WEST END

Plot Date: 8/27/2011

 TORONTO TRANSIT COMMISSION
 ENGINEERING DEPARTMENT
 Dwg. No. **SK-A-009D** Sheet No. _____

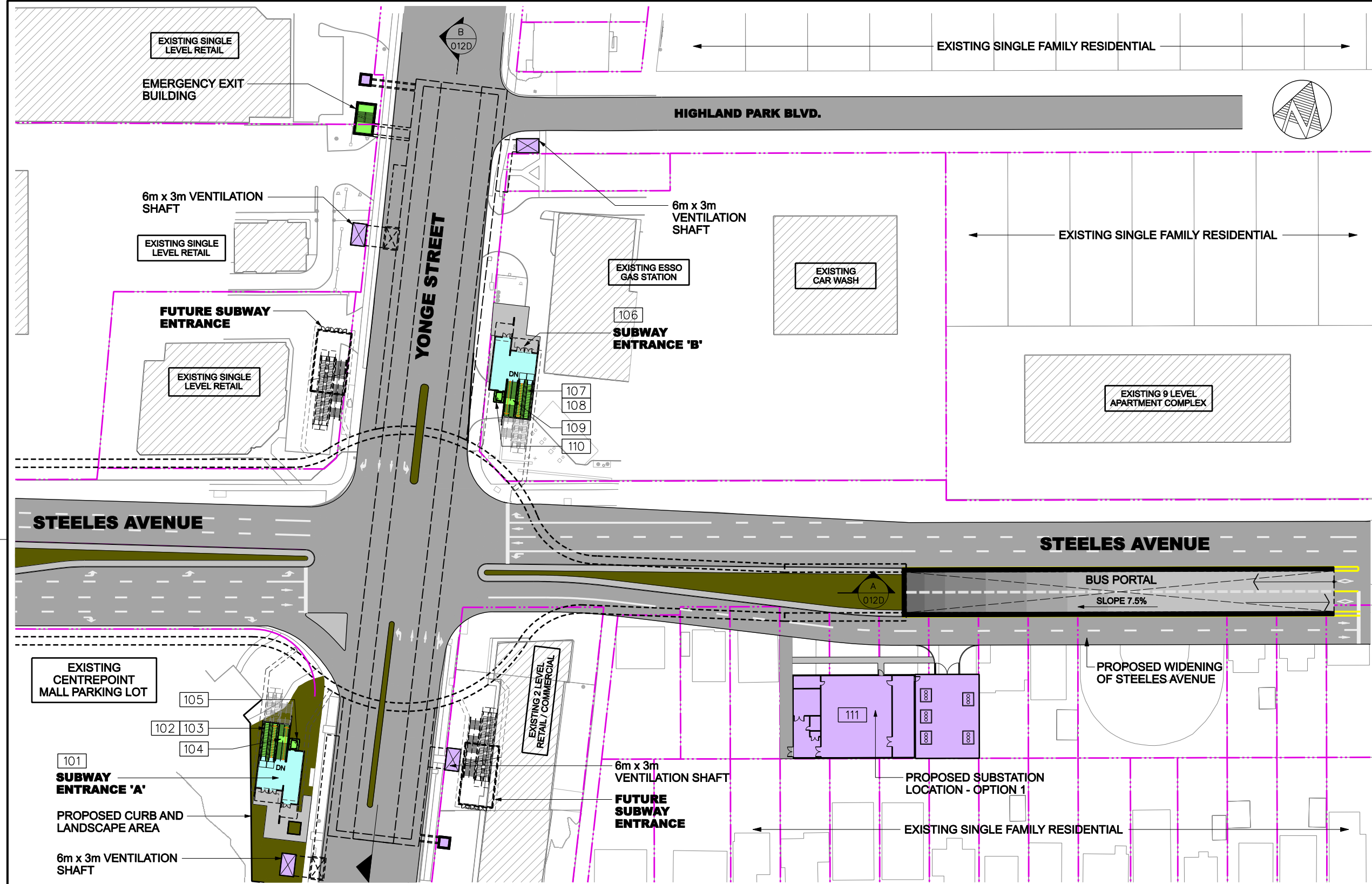

STREET LEVEL PLAN EAST END
SCALE 1:500

ROOM SCHEDULE LEGEND

RM. No.	ROOM NAME	APPROX. RM. AREA
101	SUBWAY ENTRANCE 'A'	95
102	ESCALATOR 1	-
103	ESCALATOR 2	-
104	STAIR 1	-
105	ELEVATOR 1	-
106	SUBWAY ENTRANCE 'B'	95
107	ESCALATOR 3	-
108	ESCALATOR 4	-
109	STAIR 2	-
110	ELEVATOR 2	-
111	ELECTRICAL SUBSTATION	918
112	SUBWAY ENTRANCE 'C'	120
113	STAIR 7	-
114	ELEVATOR 6	-

ROOM LEGEND - TYPICAL SUBSTATION

RM. No.	ROOM NAME	APPROX. RM. AREA
	HYDRO INCOMING LINE METERING	6
	SUBSTATION CONTROL ROOM	300
	CABLE ROOM	VARIES
	BATTERY ROOM	18
	WASHROOM	5
	STAFF LUNCH ROOM	10
	RECTIFIER ROOM	90
	TRANSFORMER YARD	300-350
	STORAGE	10
	MECHANICAL ROOM	TBD
	SERVICE ROAD /YARD	AS REQ'D
	SERVICE STAIR	* AS REQ'D
	FREIGHT LIFT /SHAFT	* AS REQ'D
	FREIGHT LIFT MACHINE RM.	* AS REQ'D

* AS REQUIRED PER INDIVIDUAL SUBSTATION

LEGEND

	ROAD
	ELEVATED ROAD
	PUBLIC AREA
	SERVICE ROOMS
	VERTICAL CIRCULATION
	RETAIL
	LANDSCAPE AREA
	NORMAL OPERATION EXIT WAY

BLDG. REF. No. FILE SHEET No. DRAWING No.

REVISIONS	REVISIONS

CONCEPTUAL DESIGN
 NOT FOR CONSTRUCTION

A member of

DRAWN: _____
 CHECKED: _____
 CORRECT: _____
 SCALE:

YONGE SUBWAY EXTENSION
STEELES STATION
 STREET LEVEL EAST END

Plot Date: 8/27/2011

 TORONTO TRANSIT COMMISSION
 ENGINEERING DEPARTMENT
 Dwg. No. **SK-A-010D** Sheet No. _____

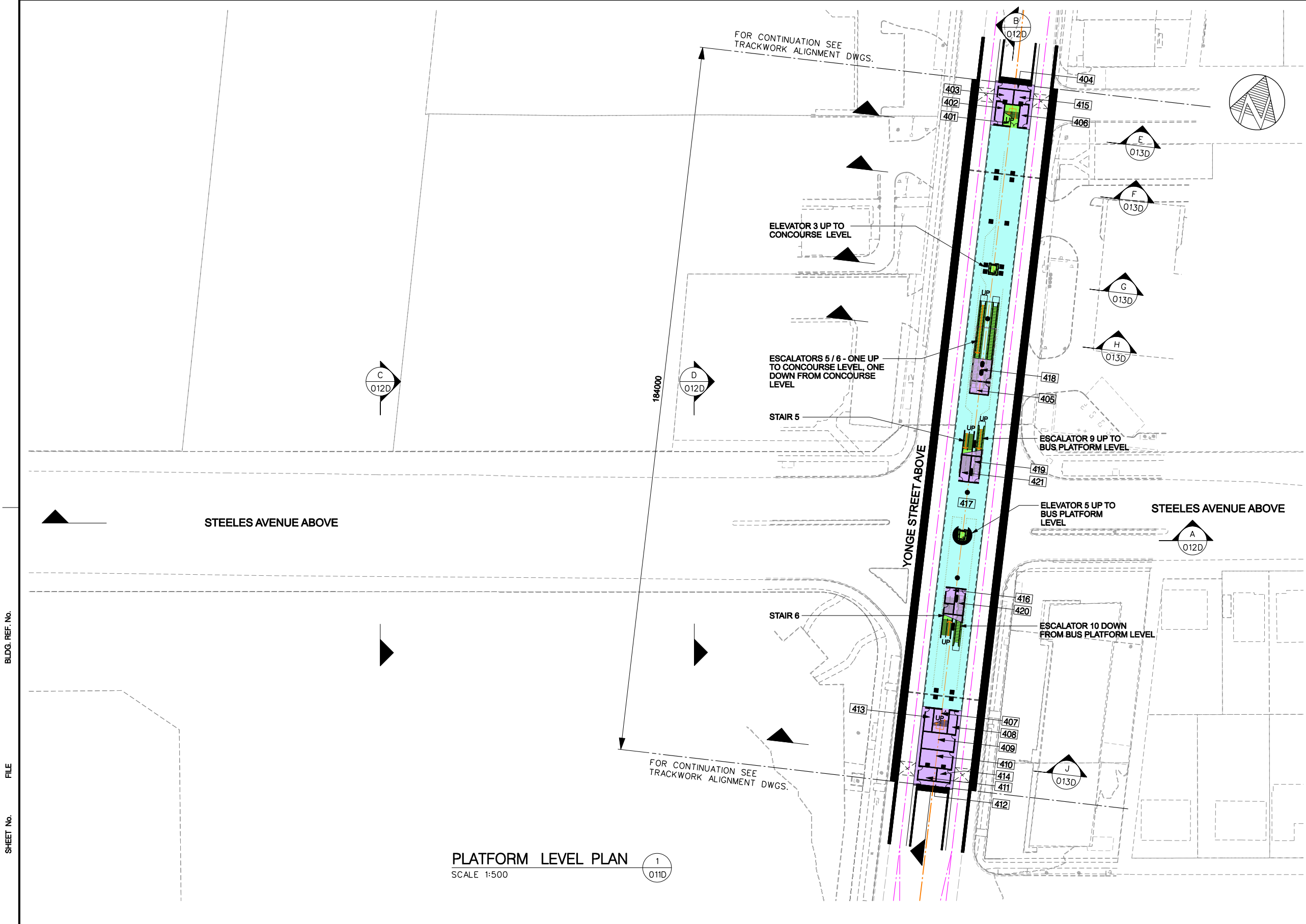

PLATFORM LEVEL PLAN
SCALE 1:500

ROOM SCHEDULE LEGEND		
RM. No.	ROOM NAME	APPROX. RM. AREA
401	EMERGENCY EXIT STAIR	24
402	CABLE PULL ROOMS	12
403	PED ROOM (E.R.R.)	12
404	FIREFIGHTERS ACCESS	12
405	JANITORS SERVICE ROOM	10
406	SUMP ROOM	12
407	SERVICE STAIR	24
408	CABLE PULL ROOMS	12
409	SIGNAL RELAY ROOM	35
410	SIGNAL POWER SUPPLY ROOM	35
411	LOCAL TOWER ROOM	16
412	FIRE FIGHTERS ACCESS	10
413	SUMP ROOM	12
414	AUXILLARY ELECTRICAL RM.	12
415	AUXILLARY ELECTRICAL RM.	12
416	ELEVATOR MACHINE RM.	9
417	SUBWAY PLATFORM	-
418	ESCALATOR SERVICE ROOM	20
419	ESCALATOR SERVICE ROOM	15
420	ESCALATOR SERVICE ROOM	15
421	ELEVATOR HVAC ROOM	15

LEGEND	
	ROAD
	ELEVATED ROAD
	PUBLIC AREA
	SERVICE ROOMS
	VERTICAL CIRCULATION
	RETAIL
	LANDSCAPE AREA
	NORMAL OPERATION EXIT WAY

DRAWING No. SHEET No. FILE BLDG. REF. No.

REVISIONS	REVISIONS

CONCEPTUAL DESIGN
 NOT FOR CONSTRUCTION

Hatch Mott MacDonald
MRC McCormick Rankin Corporation
 A member of MMM GROUP

DRAWN _____
 CHECKED _____
 CORRECT _____
 SCALE: 0 5 10 15 20m

YONGE SUBWAY EXTENSION
STEELES STATION
 PLATFORM LEVEL

Plot Date: 8/27/2011

TORONTO TRANSIT COMMISSION
 ENGINEERING DEPARTMENT
 Dwg. No. **SK-A-011D** Sheet No. _____

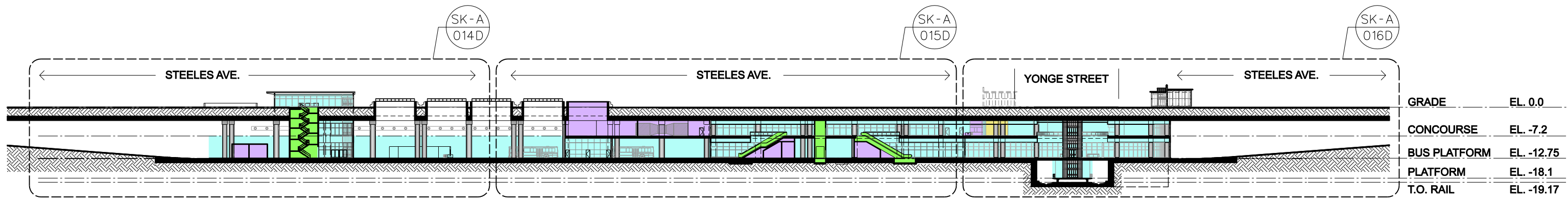

SECTION A-A
SCALE 1:500 LOOKING NORTH
A SK-A-012D

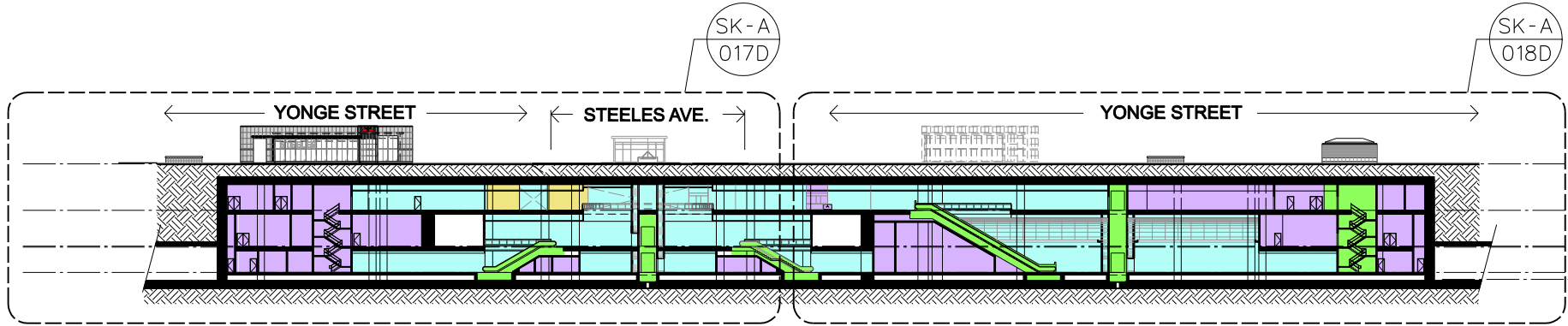

SECTION B-B
SCALE 1:500 LOOKING WEST
B SK-A-012D

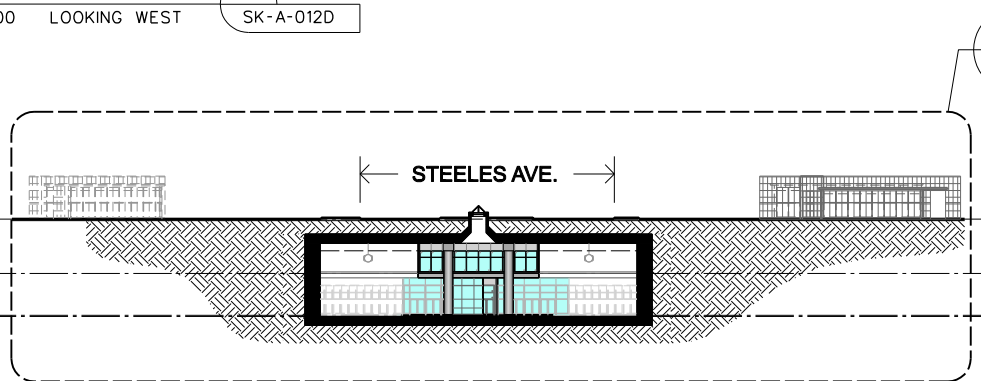

SECTION C-C
SCALE 1:500 LOOKING EAST
C SK-A-012D

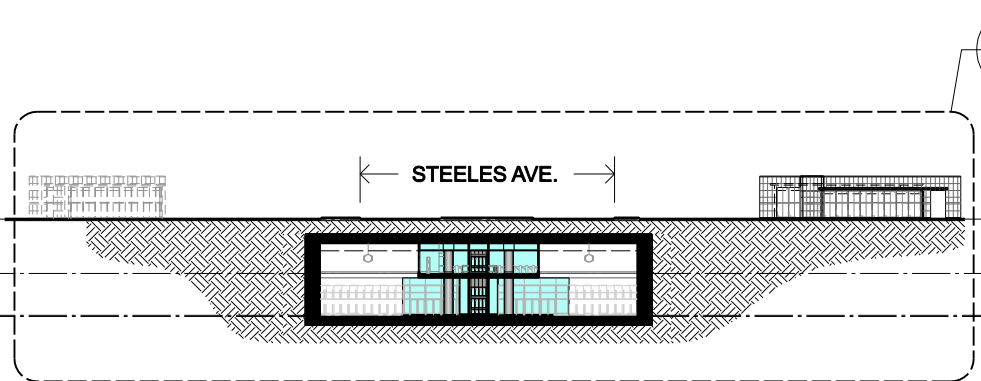

SECTION D-D
SCALE 1:500 LOOKING EAST
D SK-A-012D

- LEGEND**
- PUBLIC AREA
 - SERVICE ROOMS
 - VERTICAL CIRCULATION
 - RETAIL
 - NORMAL OPERATION EXIT WAY

BLDG. REF. No.

FILE

SHEET No.

DRAWING No.

REVISIONS	REVISIONS

CONCEPTUAL DESIGN
NOT FOR CONSTRUCTION

DRAWN _____
CHECKED _____
CORRECT _____

SCALE
0 5 10 15 20m

YONGE SUBWAY EXTENSION

STEELES STATION
OVERALL CROSS SECTIONS

Plot Date: 8/27/2011

TORONTO TRANSIT COMMISSION
ENGINEERING DEPARTMENT

Dwg. No. **SK-A-012D** Sheet No. _____

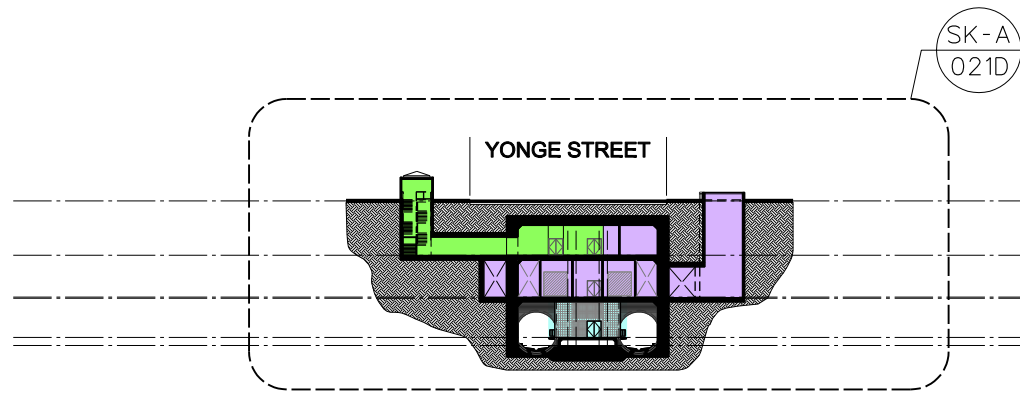

SECTION E-E
SCALE 1:500 LOOKING NORTH
A SK-A-013D

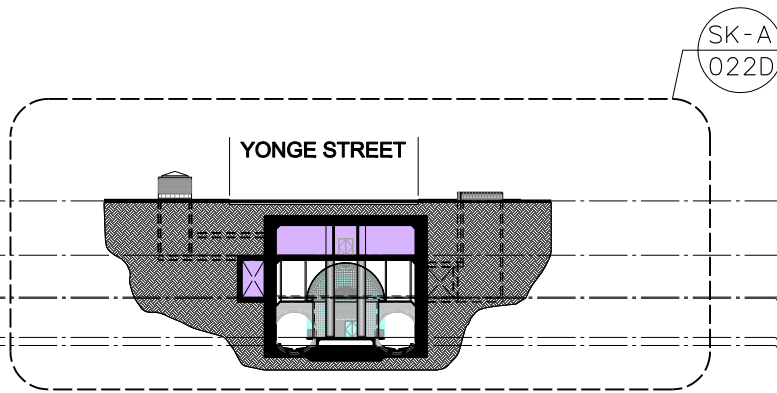

SECTION F-F
SCALE 1:500 LOOKING NORTH
B SK-A-013D

GRADE	EL. 0.0
CONCOURSE	EL. -7.2
BUS PLATFORM	EL. -12.75
BUS ROADWAY	EL. -12.9
PLATFORM	EL. -18.1
T.O. RAIL	EL. -19.17

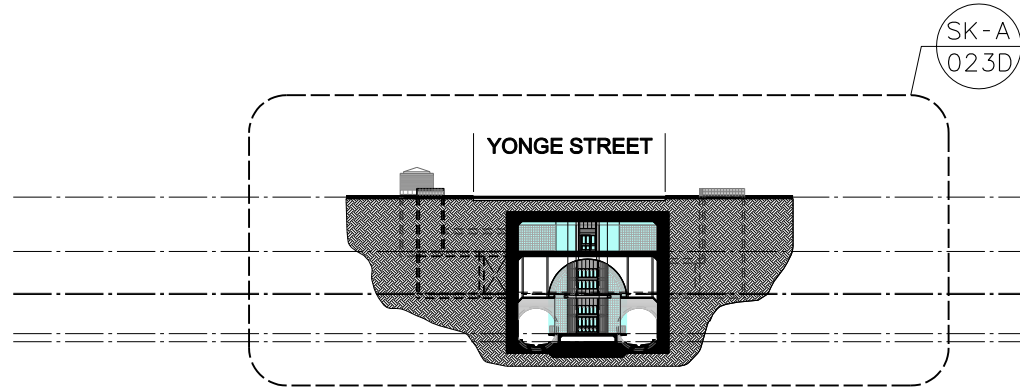

SECTION G-G
SCALE 1:500 LOOKING NORTH
C SK-A-013D

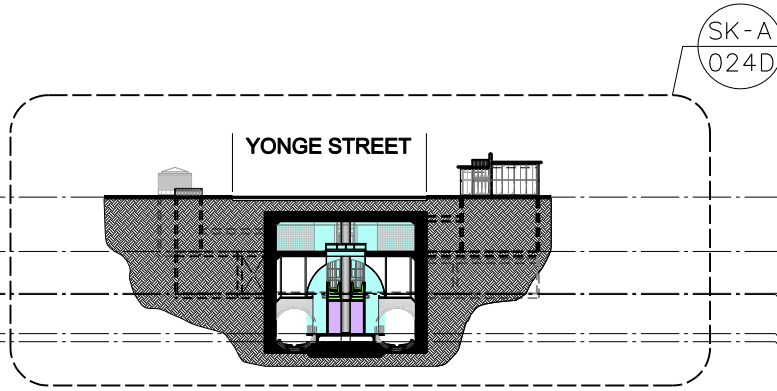

SECTION H-H
SCALE 1:500 LOOKING NORTH
D SK-A-013D

GRADE	EL. 0.0
CONCOURSE	EL. -7.2
BUS PLATFORM	EL. -12.75
BUS ROADWAY	EL. -12.9
PLATFORM	EL. -18.1
T.O. RAIL	EL. -19.17

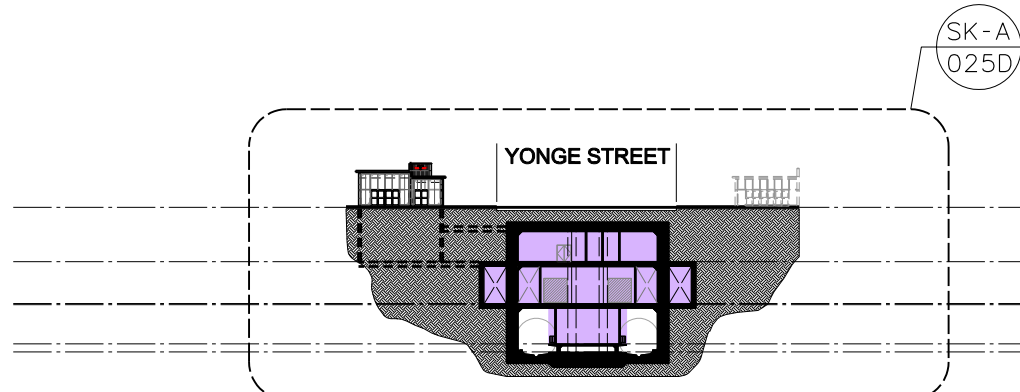

SECTION J-J
SCALE 1:500 LOOKING NORTH
D SK-A-013D

GRADE	EL. 0.0
CONCOURSE	EL. -7.2
BUS PLATFORM	EL. -12.75
BUS ROADWAY	EL. -12.9
PLATFORM	EL. -18.1
T.O. RAIL	EL. -19.17

LEGEND

- ROAD
- ELEVATED ROAD
- PUBLIC AREA
- SERVICE ROOMS
- VERTICAL CIRCULATION
- RETAIL
- LANDSCAPE AREA
- NORMAL OPERATION EXIT WAY

BLDG. REF. No.
FILE
SHEET No.

REVISIONS	REVISIONS

CONCEPTUAL DESIGN
NOT FOR CONSTRUCTION

DRAWN _____
CHECKED _____
CORRECT _____

SCALE
0 5 10 15 20m

YONGE SUBWAY EXTENSION

STEELES STATION
OVERALL CROSS SECTIONS

Plot Date: 8/27/2011

TORONTO TRANSIT COMMISSION
ENGINEERING DEPARTMENT

Dwg. No. **SK-A-013D** Sheet No. _____

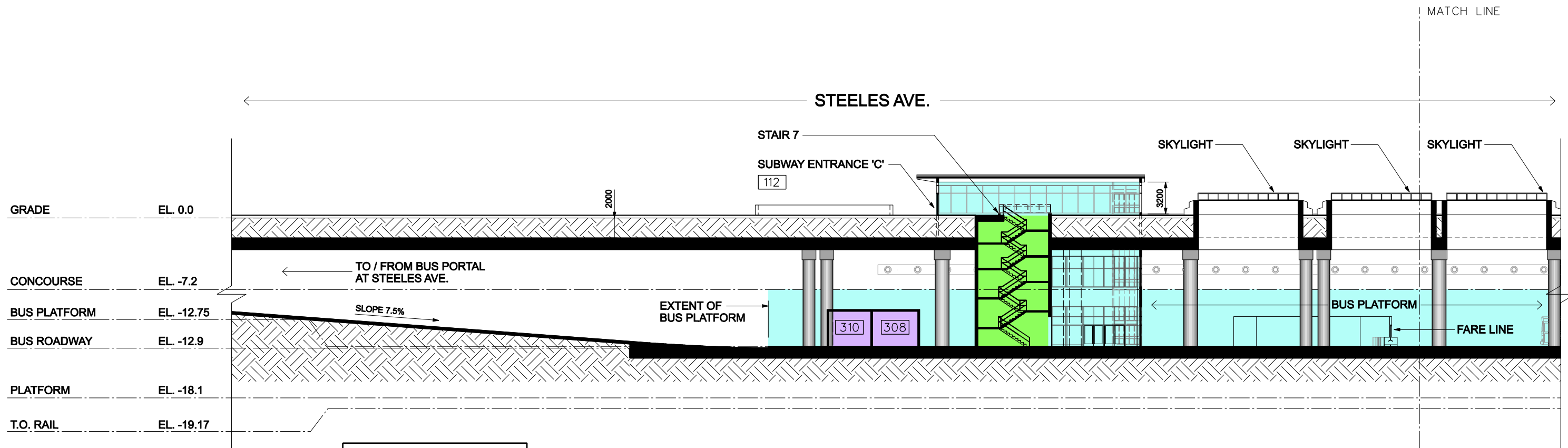

NOTE:
REFER TO PLANS FOR
ROOM SCHEDULE LEGEND

SK-A-014D | SK-A-015D

SECTION A-A WEST END
SCALE 1:200 LOOKING NORTH A SK-A-014D

- LEGEND**
- PUBLIC AREA
 - SERVICE ROOMS
 - VERTICAL CIRCULATION
 - RETAIL
 - NORMAL OPERATION EXIT WAY

BLDG. REF. No.

FILE

SHEET No.

DRAWING No.

REVISIONS	REVISIONS

CONCEPTUAL DESIGN
NOT FOR CONSTRUCTION

DRAWN _____
CHECKED _____
CORRECT _____

SCALE
0 1 2 3 4 5 6m

YONGE SUBWAY EXTENSION

STEELES STATION
PART CROSS SECTIONS

Plot Date: 8/27/2011

TORONTO TRANSIT COMMISSION
ENGINEERING DEPARTMENT

Dwg. No. **SK-A-014D** Sheet No. _____

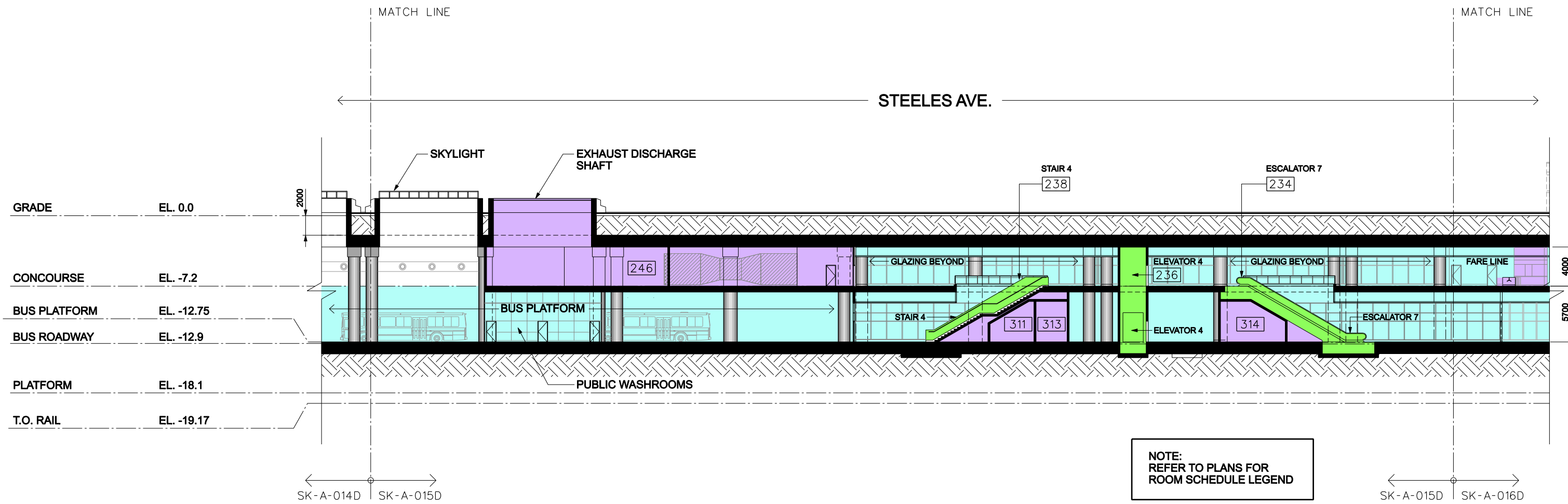

SECTION A-A – CENTRE
 SCALE 1:200 LOOKING NORTH A
 SK-A-015D

- LEGEND**
- PUBLIC AREA
 - SERVICE ROOMS
 - VERTICAL CIRCULATION
 - RETAIL
 - NORMAL OPERATION EXIT WAY

BLDG. REF. No. FILE SHEET No. DRAWING No.

REVISIONS	REVISIONS

CONCEPTUAL DESIGN
NOT FOR CONSTRUCTION

Hatch Mott MacDonald

MRC McCormick Rankin Corporation
A member of MMM GROUP

DRAWN _____
 CHECKED _____
 CORRECT _____
 SCALE

YONGE SUBWAY EXTENSION
STEELES STATION
 PART CROSS SECTIONS

Plot Date: 8/27/2011

TORONTO TRANSIT COMMISSION
 ENGINEERING DEPARTMENT
 Dwg. No. **SK-A-015D** Sheet No. _____

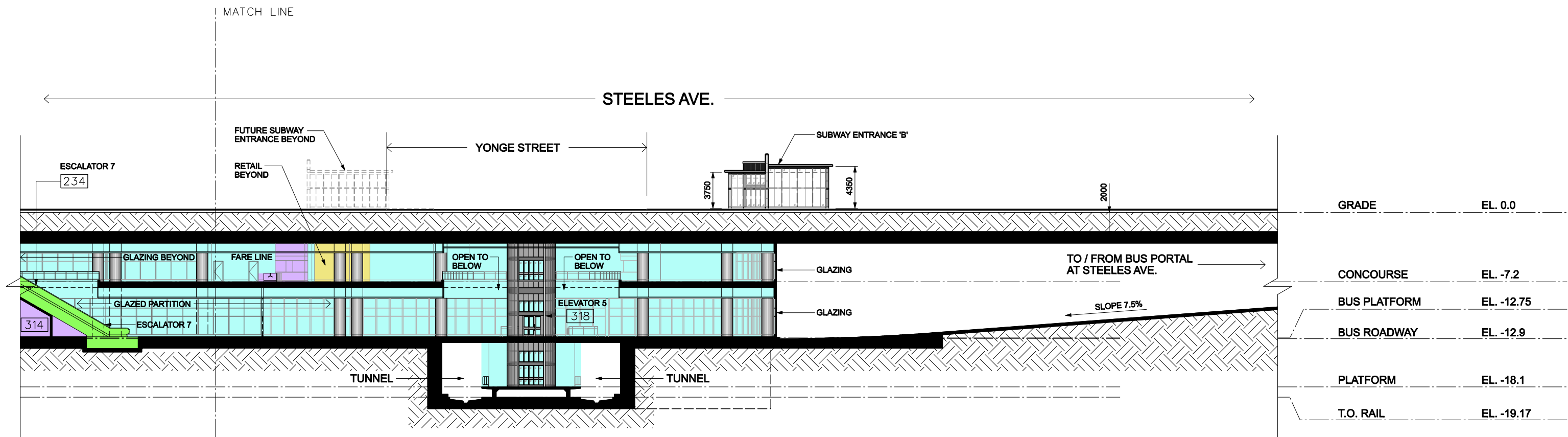

GRADE	EL. 0.0
CONCOURSE	EL. -7.2
BUS PLATFORM	EL. -12.75
BUS ROADWAY	EL. -12.9
PLATFORM	EL. -18.1
T.O. RAIL	EL. -19.17

SK-A-015D SK-A-016D

SECTION A-A – EAST END
SCALE 1:200 LOOKING NORTH

NOTE:
REFER TO PLANS FOR
ROOM SCHEDULE LEGEND

LEGEND

	PUBLIC AREA
	SERVICE ROOMS
	VERTICAL CIRCULATION
	RETAIL
	NORMAL OPERATION EXIT WAY

BLDG. REF. No. FILE SHEET No. DRAWING No.

REVISIONS	REVISIONS

CONCEPTUAL DESIGN
NOT FOR CONSTRUCTION



 A member of 

DRAWN _____
 CHECKED _____
 CORRECT _____
 SCALE: 

YONGE SUBWAY EXTENSION
STEELES STATION
 PART CROSS SECTIONS

Plot Date: 8/27/2011

 TORONTO TRANSIT COMMISSION
 ENGINEERING DEPARTMENT
 Dwg. No. **SK-A-016D** Sheet No. _____

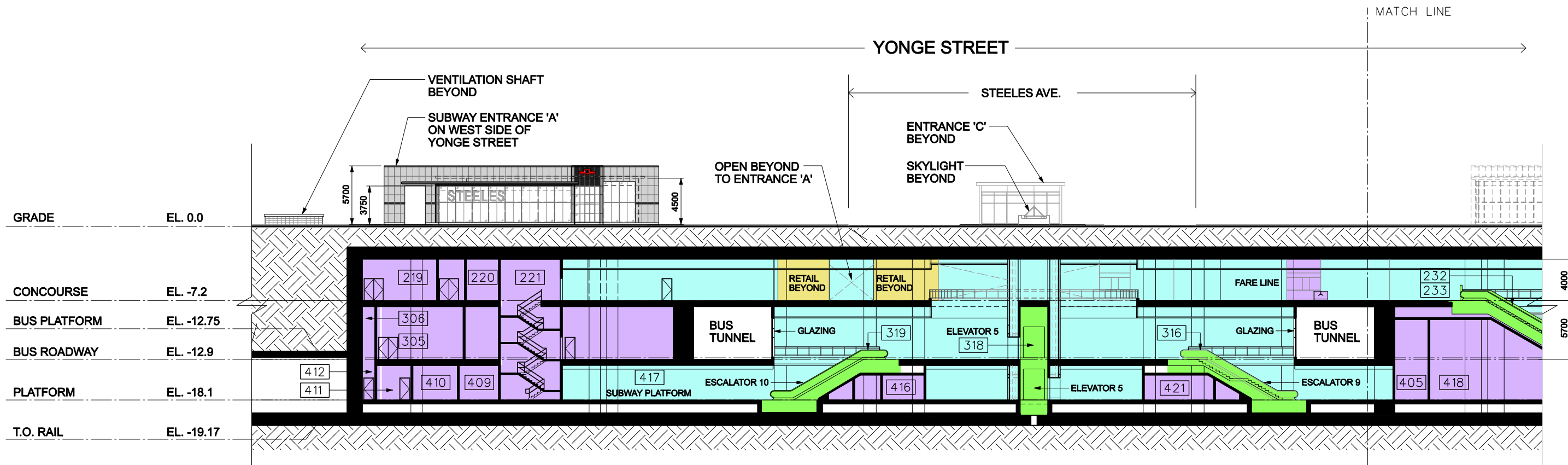

NOTE:
REFER TO PLANS FOR
ROOM SCHEDULE LEGEND

SECTION B-B - SOUTH END
SCALE 1:200
LOOKING WEST
A
SK-A-017D

SK-A-017D | SK-A-018D

- LEGEND
- PUBLIC AREA
 - SERVICE ROOMS
 - VERTICAL CIRCULATION
 - RETAIL
 - NORMAL OPERATION EXIT WAY

BLDG. REF. No. FILE SHEET No. DRAWING No.

REVISIONS	REVISIONS

CONCEPTUAL DESIGN
 NOT FOR CONSTRUCTION

DRAWN _____
 CHECKED _____
 CORRECT _____
 SCALE

YONGE SUBWAY EXTENSION
STEELES STATION
 PART CROSS SECTIONS

Plot Date: 8/27/2011

 TORONTO TRANSIT COMMISSION
 ENGINEERING DEPARTMENT
 Dwg. No. **SK-A-017D** Sheet No. _____

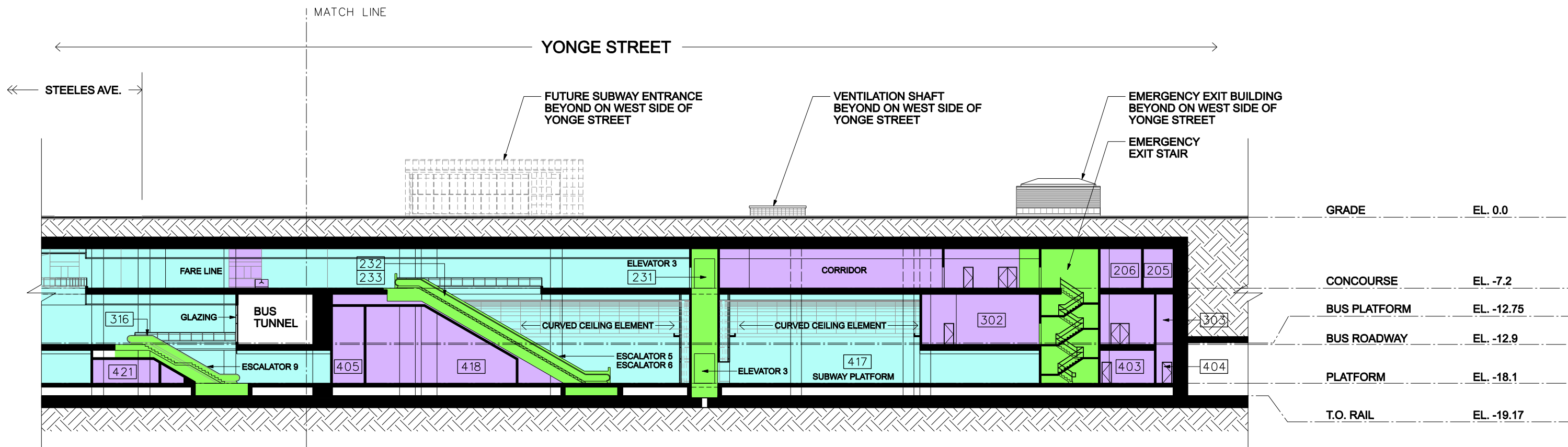

← SK-A-017D | SK-A-018D →

SECTION B-B - NORTH END
 SCALE 1:200 LOOKING WEST A SK-A-018D

NOTE:
 REFER TO PLANS FOR
 ROOM SCHEDULE LEGEND

- LEGEND**
- PUBLIC AREA
 - SERVICE ROOMS
 - VERTICAL CIRCULATION
 - RETAIL
 - NORMAL OPERATION EXIT WAY

BLDG. REF. NO.

 FILE

 SHEET No.

 DRAWING No.

REVISIONS	REVISIONS

CONCEPTUAL DESIGN
 NOT FOR CONSTRUCTION

Hatch Mott MacDonald

MRC McCormick Rankin Corporation
 A member of  **MMM GROUP**

DRAWN _____
 CHECKED _____
 CORRECT _____
 SCALE

YONGE SUBWAY EXTENSION
STEELES STATION
 PART CROSS SECTIONS

Plot Date: 8/27/2011

TORONTO TRANSIT COMMISSION
 ENGINEERING DEPARTMENT
 Dwg. No. **SK-A-018D** Sheet No. _____

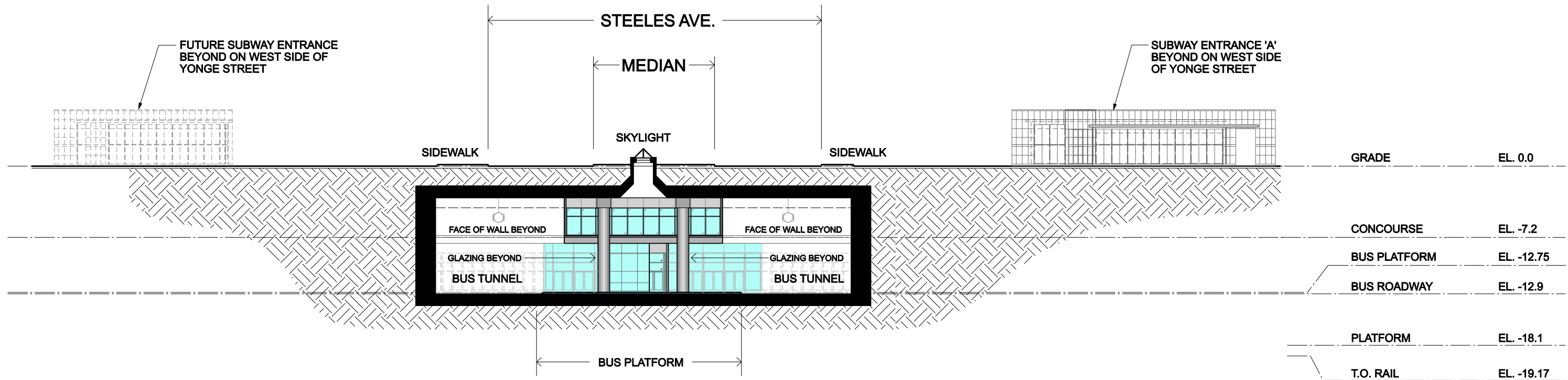

SECTION C-C
SCALE 1:200
LOOKING EAST
A SK-A-019D

NOTE:
REFER TO PLANS FOR
ROOM SCHEDULE LEGEND

- LEGEND
- PUBLIC AREA
 - SERVICE ROOMS
 - VERTICAL CIRCULATION
 - RETAIL
 - NORMAL OPERATION EXIT WAY

BLDG. REF. No.
FILE
SHEET No.
DRAWING No.

REVISIONS	REVISIONS

CONCEPTUAL DESIGN
 NOT FOR CONSTRUCTION

DRAWN _____
 CHECKED _____
 CORRECT _____
 SCALE: 0 1 2 3 4 5 8m

YONGE SUBWAY EXTENSION
STEELES STATION
 PART CROSS SECTIONS

Plot Date: 8/27/2011

 TORONTO TRANSIT COMMISSION
 ENGINEERING DEPARTMENT
 Dwg. No. SK-A-019D
 Sheet No.

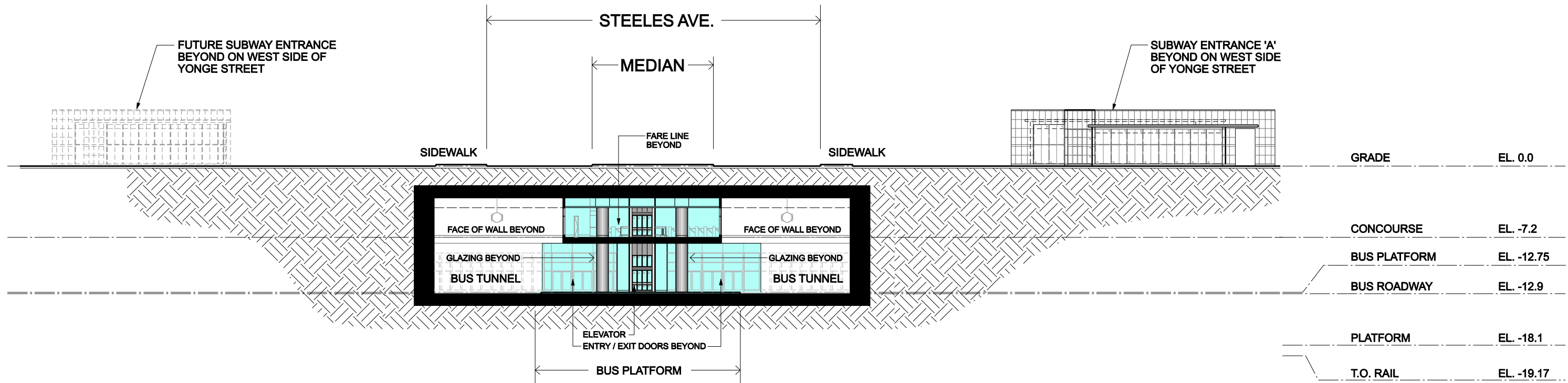

SECTION D-D
SCALE 1:200
LOOKING EAST
A SK-A-020D

NOTE:
REFER TO PLANS FOR
ROOM SCHEDULE LEGEND

- LEGEND
- PUBLIC AREA
 - SERVICE ROOMS
 - VERTICAL CIRCULATION
 - RETAIL
 - NORMAL OPERATION EXIT WAY

BLDG. REF. No.
FILE
SHEET No.
DRAWING No.

REVISIONS	REVISIONS

CONCEPTUAL DESIGN
 NOT FOR CONSTRUCTION

DRAWN _____
 CHECKED _____
 CORRECT _____
 SCALE:

YONGE SUBWAY EXTENSION
STEELES STATION
 PART CROSS SECTIONS

Plot Date: 8/27/2011

 TORONTO TRANSIT COMMISSION
 ENGINEERING DEPARTMENT
 Dwg. No. **SK-A-020D** Sheet No. _____

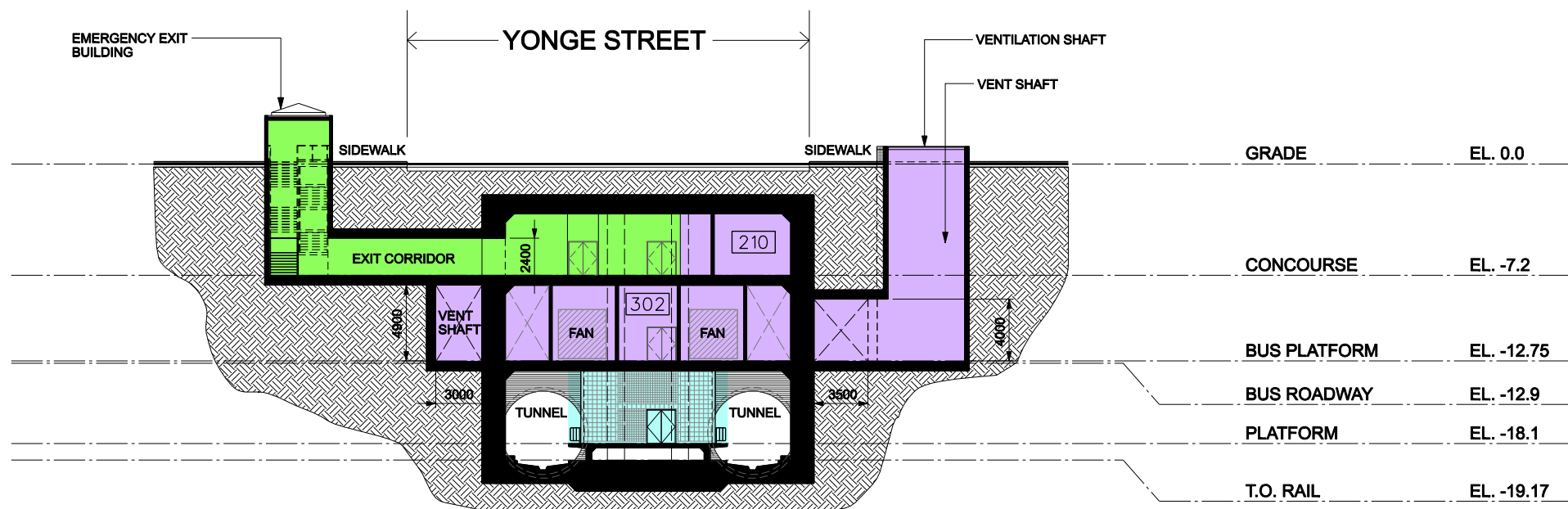

NOTE:
REFER TO PLANS FOR
ROOM SCHEDULE LEGEND

SECTION E-E
SCALE 1:200 LOOKING NORTH A
SK-A-021D

- LEGEND
- ROAD
 - ELEVATED ROAD
 - PUBLIC AREA
 - SERVICE ROOMS
 - VERTICAL CIRCULATION
 - RETAIL
 - LANDSCAPE AREA
 - NORMAL OPERATION EXIT WAY

BLDG. REF. No.
FILE
SHEET No.
DRAWING No.

REVISIONS	REVISIONS

CONCEPTUAL DESIGN
 NOT FOR CONSTRUCTION

DRAWN _____
 CHECKED _____
 CORRECT _____
 SCALE: 5m

YONGE SUBWAY EXTENSION
STEELES STATION
 PART CROSS SECTIONS

Plot Date: 8/27/2011

 TORONTO TRANSIT COMMISSION
 ENGINEERING DEPARTMENT
 Dwg. No. **SK-A-021D** Sheet No. _____

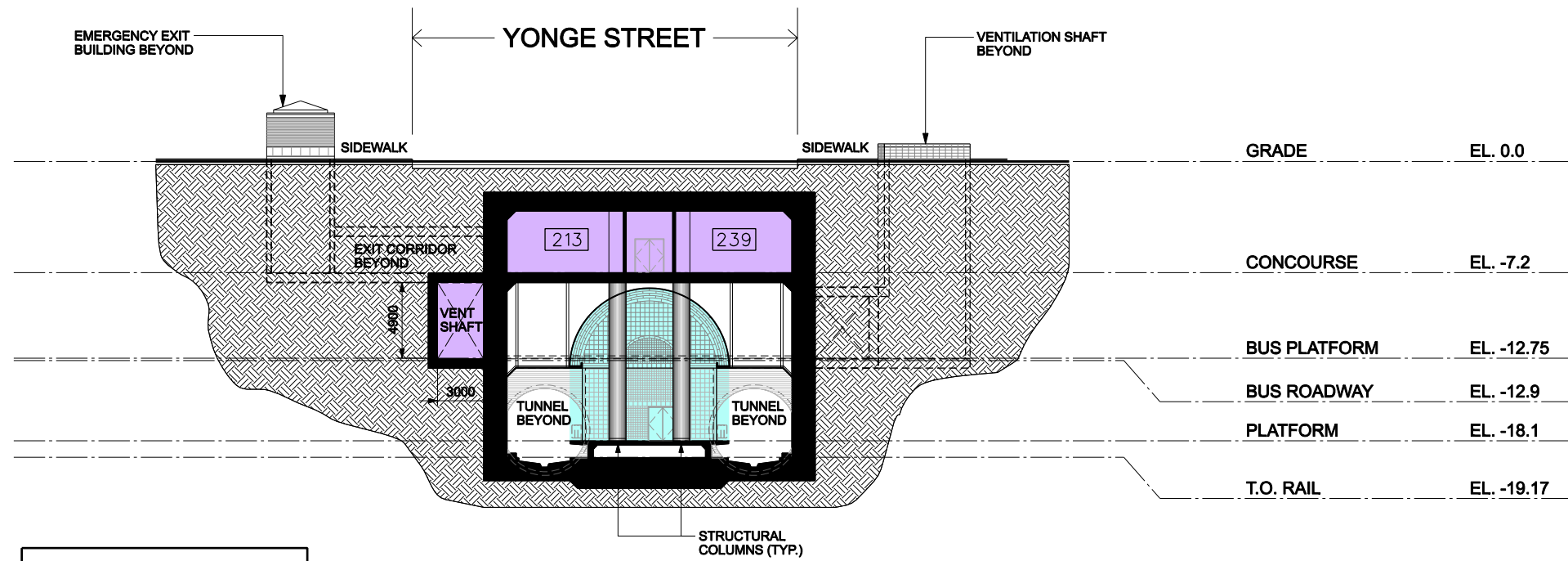

NOTE:
REFER TO PLANS FOR
ROOM SCHEDULE LEGEND

SECTION F-F
SCALE 1:200 LOOKING NORTH A
SK-A-022D

- LEGEND
- ROAD
 - ELEVATED ROAD
 - PUBLIC AREA
 - SERVICE ROOMS
 - VERTICAL CIRCULATION
 - RETAIL
 - LANDSCAPE AREA
 - NORMAL OPERATION EXIT WAY

BLDG. REF. No. FILE SHEET No. DRAWING No.

REVISIONS	REVISIONS

CONCEPTUAL DESIGN
 NOT FOR CONSTRUCTION

DRAWN _____
 CHECKED _____
 CORRECT _____
 SCALE: 5m

YONGE SUBWAY EXTENSION
STEELES STATION
 PART CROSS SECTIONS

Plot Date: 8/27/2011

 TORONTO TRANSIT COMMISSION
 ENGINEERING DEPARTMENT
 Dwg. No. **SK-A-022D** Sheet No. _____

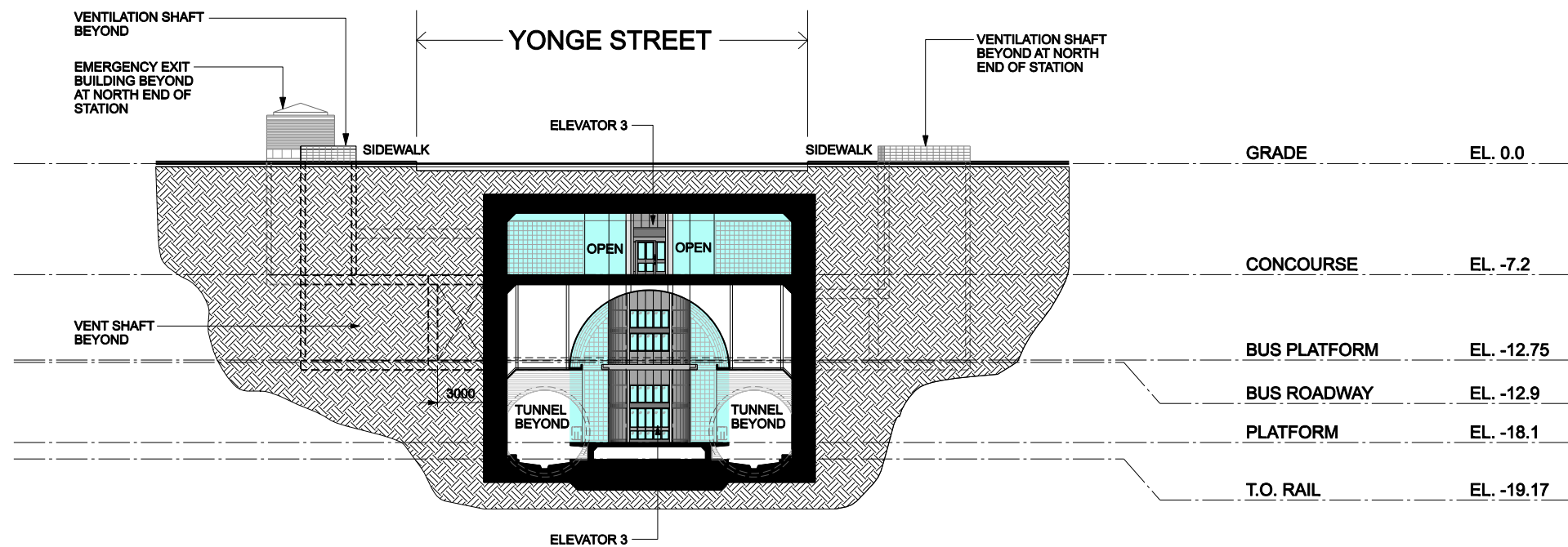

NOTE:
REFER TO PLANS FOR
ROOM SCHEDULE LEGEND

SECTION G-G
SCALE 1:200 LOOKING NORTH A
SK-A-023D

- LEGEND
- ROAD
 - ELEVATED ROAD
 - PUBLIC AREA
 - SERVICE ROOMS
 - VERTICAL CIRCULATION
 - RETAIL
 - LANDSCAPE AREA
 - NORMAL OPERATION EXIT WAY

BLDG. REF. No.
FILE
SHEET No.
DRAWING No.

REVISIONS	REVISIONS

CONCEPTUAL DESIGN
 NOT FOR CONSTRUCTION

Hatch Mott MacDonald
McCormick Rankin Corporation
A member of MMM GROUP

DRAWN _____
 CHECKED _____
 CORRECT _____
 SCALE:

YONGE SUBWAY EXTENSION
STEELES STATION
 PART CROSS SECTIONS

Plot Date: 8/27/2011

 TORONTO TRANSIT COMMISSION
 ENGINEERING DEPARTMENT
 Dwg. No. **SK-A-023D** Sheet No. _____

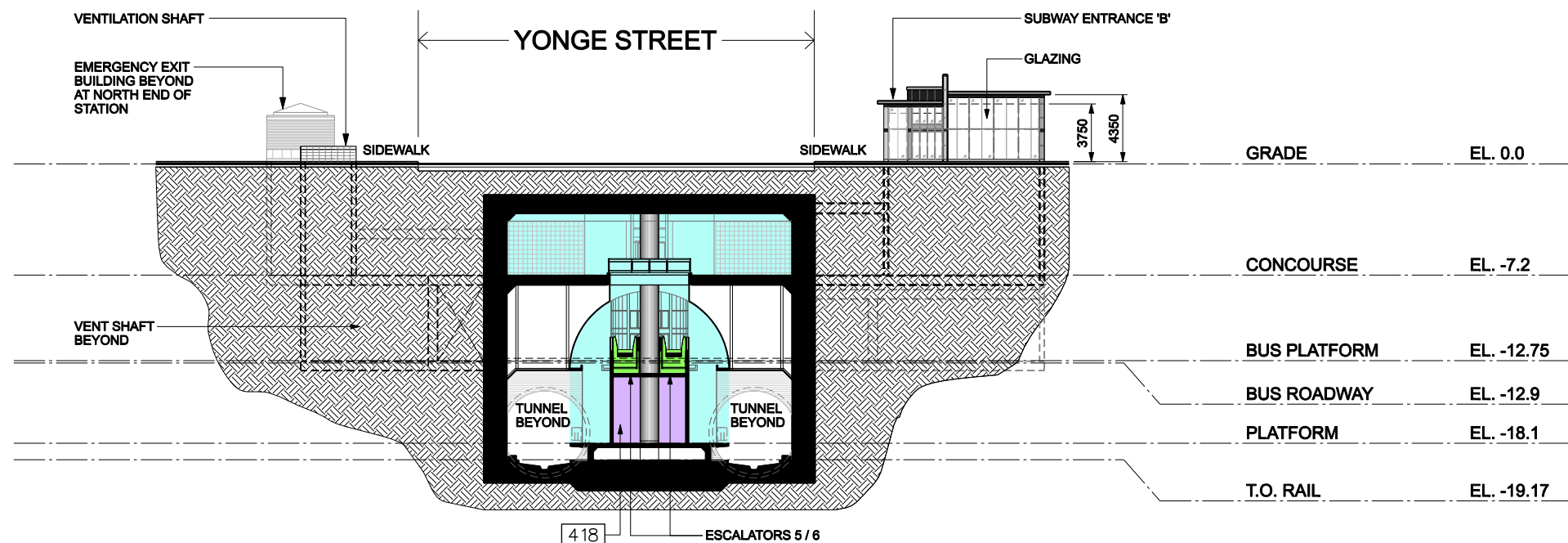

NOTE:
REFER TO PLANS FOR
ROOM SCHEDULE LEGEND

SECTION H-H
SCALE 1:200 LOOKING NORTH A SK-A-024D

- LEGEND
- ROAD
 - ELEVATED ROAD
 - PUBLIC AREA
 - SERVICE ROOMS
 - VERTICAL CIRCULATION
 - RETAIL
 - LANDSCAPE AREA
 - NORMAL OPERATION EXIT WAY

BLDG. REF. No. FILE SHEET No. DRAWING No.

REVISIONS	REVISIONS
△	△
△	△
△	△

CONCEPTUAL DESIGN
NOT FOR CONSTRUCTION

DRAWN _____

CHECKED _____

CORRECT _____

SCALE

YONGE SUBWAY EXTENSION

STEELES STATION

PART CROSS SECTIONS







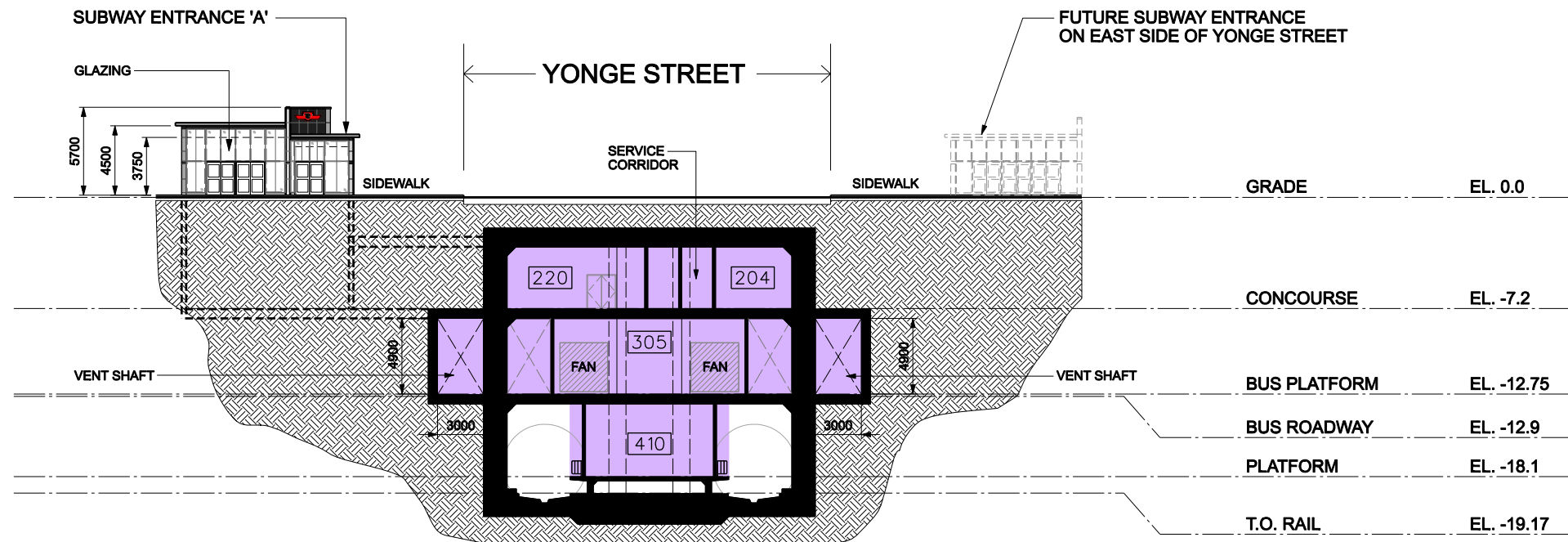

Plot Date: 8/27/2011

TORONTO TRANSIT COMMISSION
ENGINEERING DEPARTMENT

Dwg. No. SK-A-024D Sheet No.



SECTION J-J
SCALE 1:200
LOOKING NORTH
A
SK-A-025D

- LEGEND
-  ROAD
 -  ELEVATED ROAD
 -  PUBLIC AREA
 -  SERVICE ROOMS
 -  VERTICAL CIRCULATION
 -  RETAIL
 -  LANDSCAPE AREA
 -  NORMAL OPERATION EXIT WAY

BLDG. REF. No.
FILE
SHEET No.
DRAWING No.

REVISIONS	REVISIONS

CONCEPTUAL DESIGN
 NOT FOR CONSTRUCTION



DRAWN _____
 CHECKED _____
 CORRECT _____
 SCALE:  5m

YONGE SUBWAY EXTENSION
STEELES STATION
 PART CROSS SECTIONS

Plot Date: 8/27/2011

 TORONTO TRANSIT COMMISSION
 ENGINEERING DEPARTMENT
 Dwg. No. **SK-A-025D** Sheet No. _____

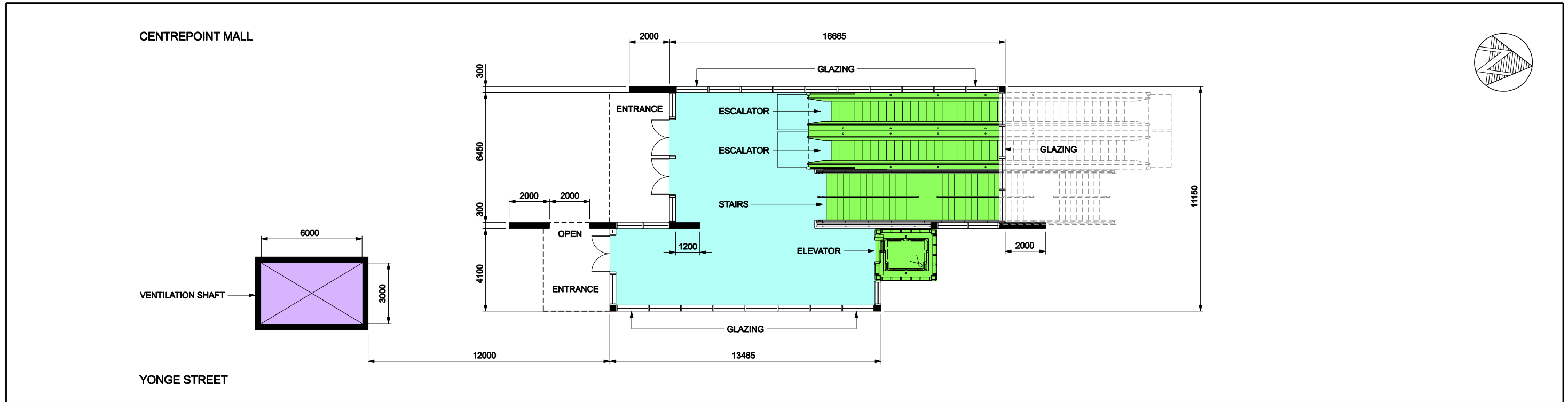

SUBWAY ENTRANCE 'A' PLAN
SCALE 1:100

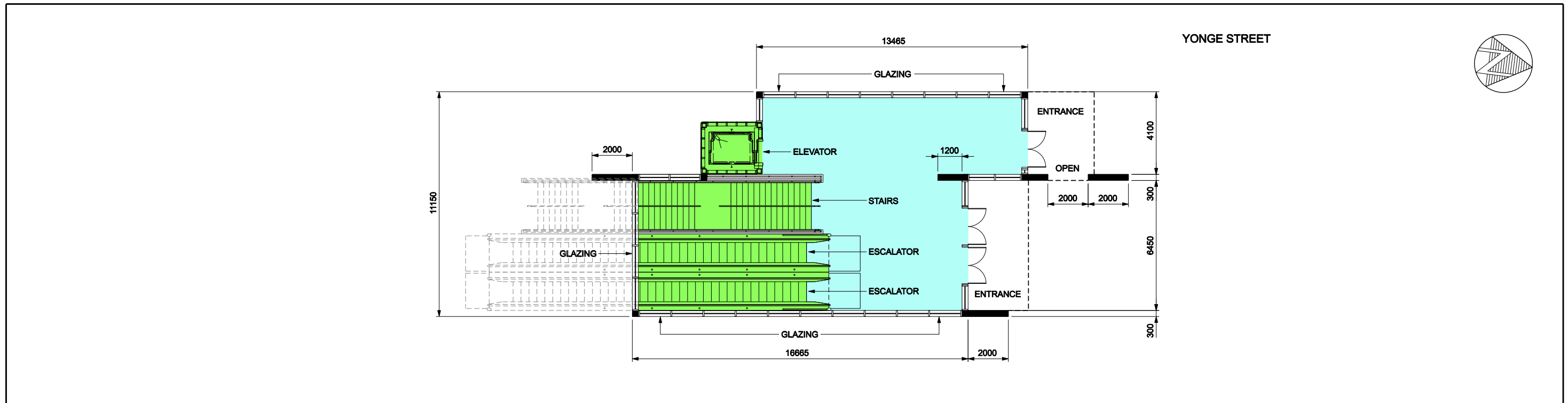

SUBWAY ENTRANCE 'B' PLAN
SCALE 1:100

DRAWING No. SHEET No. FILE BLDG. REF. No.

REVISIONS	REVISIONS

CONCEPTUAL DESIGN
 NOT FOR CONSTRUCTION



DRAWN _____
 CHECKED _____
 CORRECT _____

SCALE
 0 1 2 3 4m

YONGE SUBWAY EXTENSION

STEELES STATION
STREET LEVEL - ENTRANCES

Plot Date: 8/27/2011

TORONTO TRANSIT COMMISSION
ENGINEERING DEPARTMENT

Dwg. No. **SK-A-026D** Sheet No. _____

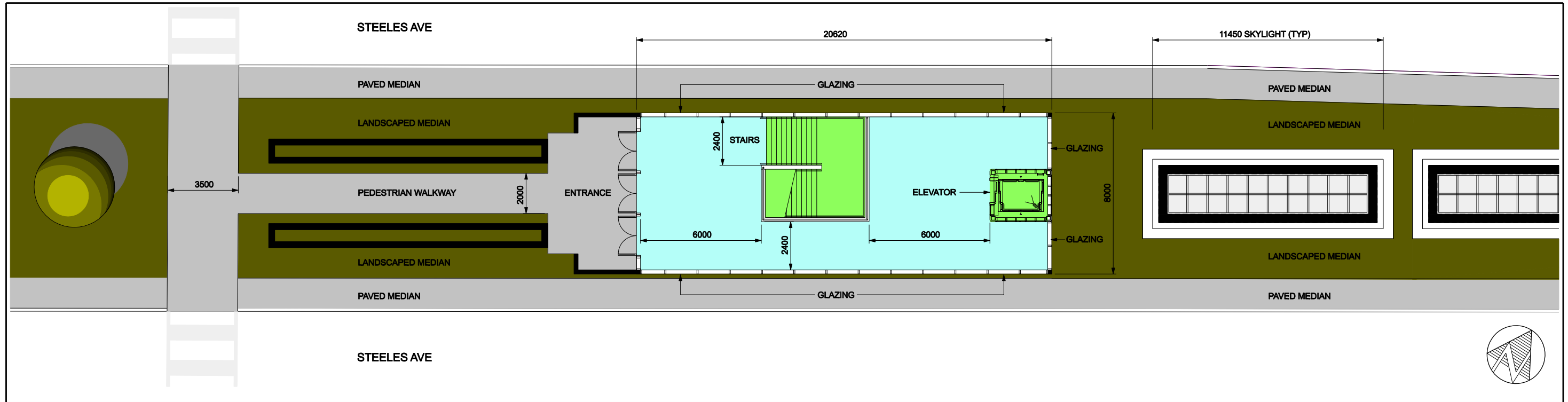

SUBWAY ENTRANCE 'C' PLAN
SCALE 1:100

1
027D

BLDG. REF. No.

FILE

SHEET No.

DRAWING No.

REVISIONS	REVISIONS

CONCEPTUAL DESIGN
NOT FOR CONSTRUCTION

MRC McCORMICK RANKIN CORPORATION
A member of **MMM GROUP**

Hatch Mott MacDonald

DRAWN
CHECKED
CORRECT
SCALE
0 1 2 3 4m

YONGE SUBWAY EXTENSION
STEELES STATION
STREET LEVEL - ENTRANCES

Plot Date: 8/27/2011

TORONTO TRANSIT COMMISSION
ENGINEERING DEPARTMENT
Dwg. No. **SK-A-027D** Sheet No.

9. CLARK STATION

Clark Station is located under Yonge Street at Clark Avenue with the majority of the station box positioned north of Clark Avenue. The station's zone of influence would cover an area bounded approximately by Springfield Way to the east, Willowdale Boulevard to the west, CN York Subdivision to the south, and Arnold Avenue/Elgin Street to the north. The Clark Station location provides an opportunity for intensification in addition to the existing medium and high density development.

The main station entrance will be located on the north east corner of the intersection with a secondary (automatic) entrance located at the north end of the station on the west side of Yonge Street. A passageway connection to a future secondary entrance located on the south west corner of the intersection will be provided as well as a knock-out panel for a future secondary entrance on the south east corner. A two-level substation will be situated adjacent to and above the main entrance building and an at-grade 3-bay bus platform has been added as a result of the reduction in underground bus spaces at Steeles Station. The station entrance, substation and bus platforms are all located on the same parcel of property that was identified in the TPAP.

Key design considerations for the combined station entrance/substation/bus loop are as follows:

- Provide convenient transfers between the connecting bus routes and the subway entrances
- Protect for integration into planned future redevelopment in the southeast quadrant of Yonge Street and Clark Avenue, making for a more attractive station entrance
- Minimize property impacts on stable residential lands and high density lands adjacent to station entrances.

9.1 Passenger Transfer Movements

The passenger transfer movements at Clark Station were estimated based on the passenger demand forecast analysis described in Section 2 and Appendix 'A' of this report. A breakdown of the forecast 2031 AM peak hour transfer movements by mode and by direction can be found in **Table 9-1**.

Table 9-1: Estimated Passenger Transfer Movements at Clark Station (2031)

TRANSFERS		OUT OF STATION					TOTAL
INTO STATION	DIR	SUBWAY		YRT		WALK OUT	
		NB	SB	NB	WB		
SUBWAY	NB	0	0	0	0	40	40
	SB	0	0	0	0	90	90
YRT	EB	0	170	0	0	10	180
	NB	10	150	0	0	0	160
	SB	0	10	0	0	10	20
WALK IN		90	310	20	20	0	440
TOTAL		100	640	20	20	150	930

As shown in Table 9-1, transfer movements at Clark Station are largely split between the walk-subway pair and the bus-subway pair. Of the total 930 AM peak hour passenger movements projected at Clark Station, about 57% (530) are between the subway and walk-in/out while 37% (340) are between the subway and connecting bus routes.

Passenger flow diagrams prepared for Clark Station can be found in Appendix 'E' of this report.

9.2 Station Entrances

Consistent with the TPAP recommendations, the Main Entrance is located in the northeast corner of Yonge Street and Clark Avenue with a 3-bay bus loop wrapping around it. A Secondary Entrance is provided in the southwest corner of the Yonge/Clark intersection. An Automatic Entrance is located on the west side of Yonge north of Clark Avenue. An entrance building in the southeast corner of the intersection – identified during the TPAP as a future entrance in anticipation of planned redevelopment onsite – has been protected as a future developer connection. Given the location of the collector's booth and fare line on the concourse level, this future connection can provide free access though the developer will still have to provide TTC grade elevator, escalators, and signage that must remain accessible through the same hours of operation as the TTC station.

The Main Entrance is fully accessible with an elevator, two escalators, and stairs, while the Secondary Entrance provides an escalator and set of stairs with the possibility of a second elevator. The Automatic Entrance has been designed with an escalator, stairs, and provision for future installation of a third elevator route. We recommend that the structural elements of all elevators are built in order to reduce the cost and impact of adding these vertical circulation elements in the future.

9.3 Street Level

Emergency ventilation shafts are located on both sides of Yonge Street south of the intersection with Clark Avenue. At the north end of the station the vent shafts are located on both sides of Yonge Street.

Note that additional station ventilation shafts are required for normal exhaust and makeup air to staffed spaces below grade, and will be sized and located in the next phase of design.

Fire Fighter's Access shafts are located on the east side of Yonge Street; one opposite the Automatic Entrance, and one on the southeast corner of Yonge and Clark Avenue.

9.4 Concourse Level

In order to reduce the station box length, utility rooms have been located at concourse level thus dividing the concourse in two. This layout also provides the fire separation for two egress routes required under OBC 3.13 from platform to surface. A public passageway connects the two areas on the east side of the concourse with two sets of fire doors. It is likely that this corridor will also require sprinklers to meet code requirements. Emergency ventilation fans are also located at concourse level, with two fan assemblies located at each end of the station box.

Entering the concourse from the Main Entrance, patrons move past the Collector’s Booth and through a low gate fare array. We are recommending the Collector’s Booth be located on the south end of the fare array, contrary to the traditional “right-hand flow”, in order that the collector will have the best view of the south concourse and associated passenger flows. Moving through the fare line patrons have two escalators, a set of stairs and an elevator down to platform.

Entering the concourse from the second Entrance Building, patrons move past the second Collector’s Booth and through a low gate fare array. Note that future discussions with TTC Collectors Division could result in this booth being designated for part-time occupancy, in which case this would be converted to a high fare array. We are recommending that this Collector’s Booth also be located on the north end of the fare array, contrary to the traditional “right-hand flow”, in order that the collector will have the best view towards the primary collector’s booth and associated passenger flows.

Entering the concourse from the Automatic Entrance patrons move through a high gate fare array, with provision for future installation of an Easier Access Portal Unit (EAPU), and then have two escalators and a set of stairs providing access to the platform. Provision has also been made for installation of a future elevator from the north concourse to the platform. A knockout panel is also provided to allow for a future developer connection from the east side of Yonge Street.

9.5 Platform Level

The center platform is 152.4m long to accommodate the current six-car train consists operated by TTC. As this is the standard length for platforms in the TTC subway system it is assumed that future ATC (Automatic Train Control) train operation will allow the operation of longer trains, including the possibility of seven-car consists.

Patrons move between concourse and platform using four escalators, two sets of stairs, and an elevator. Provision has been made for the addition of a second elevator route through the north concourse. Vertical circulation has been designed to accommodate both normal and emergency passenger loads using the normal vertical circulation elements. This is our preferred design approach, as observation has shown that in emergencies, people tend to follow familiar routes out of buildings rather than follow emergency exits routes.

9.6 Electrical Substation

As identified in the TPAP, the substation would be located above the Main Entrance building in the northeast corner of the Yonge Street/Clark Avenue intersection. Two options for locating the traction power substation have been shown above the Main Entrance; the first is a 2-storey substation with some rooms at grade, the alternate layout elevates the entire substation above the Main Entrance/Bus Loop. The second option allows for retail at grade, and adds mass to the station which may contribute to urban design street-wall affect.

9.7 Bus Loop

The proposed bus bay allocation for YRT routes are summarized in **Table 9-2**.

Table 9-2: Proposed YRT Bus Bay Allocation at Clark Station

Route	Type	Future Peak Headway (minutes’ seconds’)	No. of Bus Bays
2/2A Milliken/14 th Ave	Terminating	10’ 00’’	1 (Shared)
5 Clark	Terminating	10’ 00’’	
23 Thornhill Woods	Terminating	15’ 00’’	1 (Shared)
77 Highway 7/Centre	Terminating	15’ 00’’	
99 Yonge (Southbound)	Through	10’ 00’’	0
99 Yonge (Northbound)	Through	10’ 00’’	0
		Mobility Plus	Use least busiest bay
		Future Service Growth	1
		Unload Only	
		TOTAL	3

9.8 Utilities and Relocation Strategy

The majority of the underground utilities in the vicinity of the Clark Station are north / south along the west side of the roadway right-of-way and are beyond the influence of the proposed station with the exception of the two entrance locations on the west side. The proposed entrance building in the northwest quadrant will require the relocation of two small diameter sanitary sewers and one 1350mm diameter storm sewer. There is a 250mm sanitary sewer and a 250mm watermain that will require relocation along the east side of the station. The local storm sewers within the road will need to be temporarily relocated during construction but can be reinstated within the roadway above the station box once station construction has been completed.

Existing gas and hydro infrastructure will require relocation during construction and hydro infrastructure may need improvements in order to provide the required power to the substation located at this station.

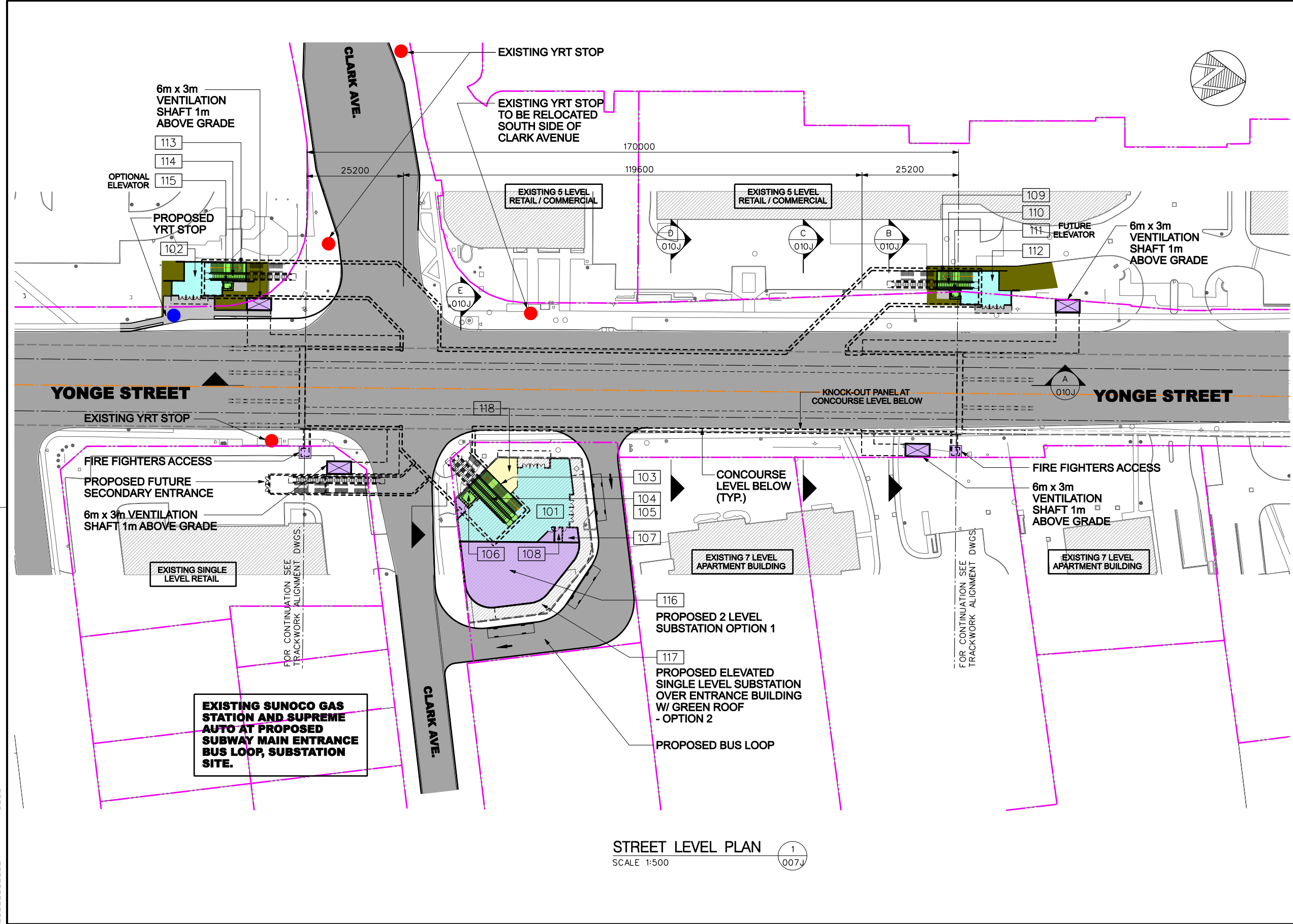

STREET LEVEL PLAN
SCALE 1:500

ROOM SCHEDULE LEGEND		
RM. No.	ROOM NAME	APPROX. RM. AREA
101	MAIN SUBWAY ENTRANCE	365
102	SECONDARY ENTRANCE	82
103	STAIR 1	-
104	ESCALATOR 1	-
105	ESCALATOR 2	-
106	ELEVATOR 1	-
107	BUS OPERATOR WASHROOM	10
108	JANITOR CLOSET	6
109	STAIR 2	-
110	ESCALATOR 3	-
111	FUTURE ELEVATOR 2	-
112	AUTOMATIC ENTRANCE	82
113	STAIR 3	-
114	ESCALATOR 4	-
115	ELEVATOR 3 (OPTIONAL)	-
116	ELECTRICAL SUBSTATION OPT.1	930
117	ELECTRICAL SUBSTATION OPT.2	1200
118	RETAIL	45

ROOM LEGEND - TYPICAL SUBSTATION		
RM. No.	ROOM NAME	APPROX. RM. AREA
	HYDRO INCOMING LINE METERING	6
	SUBSTATION CONTROL ROOM	300
	CABLE ROOM	VARIES
	BATTERY ROOM	18
	WASHROOM	5
	STAFF LUNCH ROOM	10
	RECTIFIER ROOM	90
	TRANSFORMER YARD	300-350
	STORAGE	10
	MECHANICAL ROOM	TBD
	SERVICE ROAD /YARD	AS REQ'D
	SERVICE STAIR	* AS REQ'D
	FREIGHT LIFT /SHAFT	* AS REQ'D
	FREIGHT LIFT MACHINE RM.	* AS REQ'D

* AS REQUIRED PER INDIVIDUAL SUBSTATION

LEGEND	
[Grey Box]	ROAD
[Light Grey Box]	ELEVATED ROAD
[Light Blue Box]	PUBLIC AREA
[Light Purple Box]	SERVICE ROOMS
[Light Green Box]	VERTICAL CIRCULATION
[Yellow Box]	RETAIL
[Dark Green Box]	LANDSCAPE AREA
[Dashed Line]	NORMAL OPERATION EXIT WAY

DRAWING No. SHEET No. FILE BLDG. REF. No.

REVISIONS	REVISIONS

CONCEPTUAL DESIGN
 NOT FOR CONSTRUCTION

Hatch Mott MacDonald
MRC McCormick Rankin Corporation
 A member of MMM GROUP

DRAWN	
CHECKED	
CORRECT	
SCALE	0 5 10 15 20m

YONGE SUBWAY EXTENSION
CLARK STATION
 STREET LEVEL

Plot Date: 8/26/2011

TORONTO TRANSIT COMMISSION
 ENGINEERING DEPARTMENT
 Dwg. No. **SK-A-007J** Sheet No.

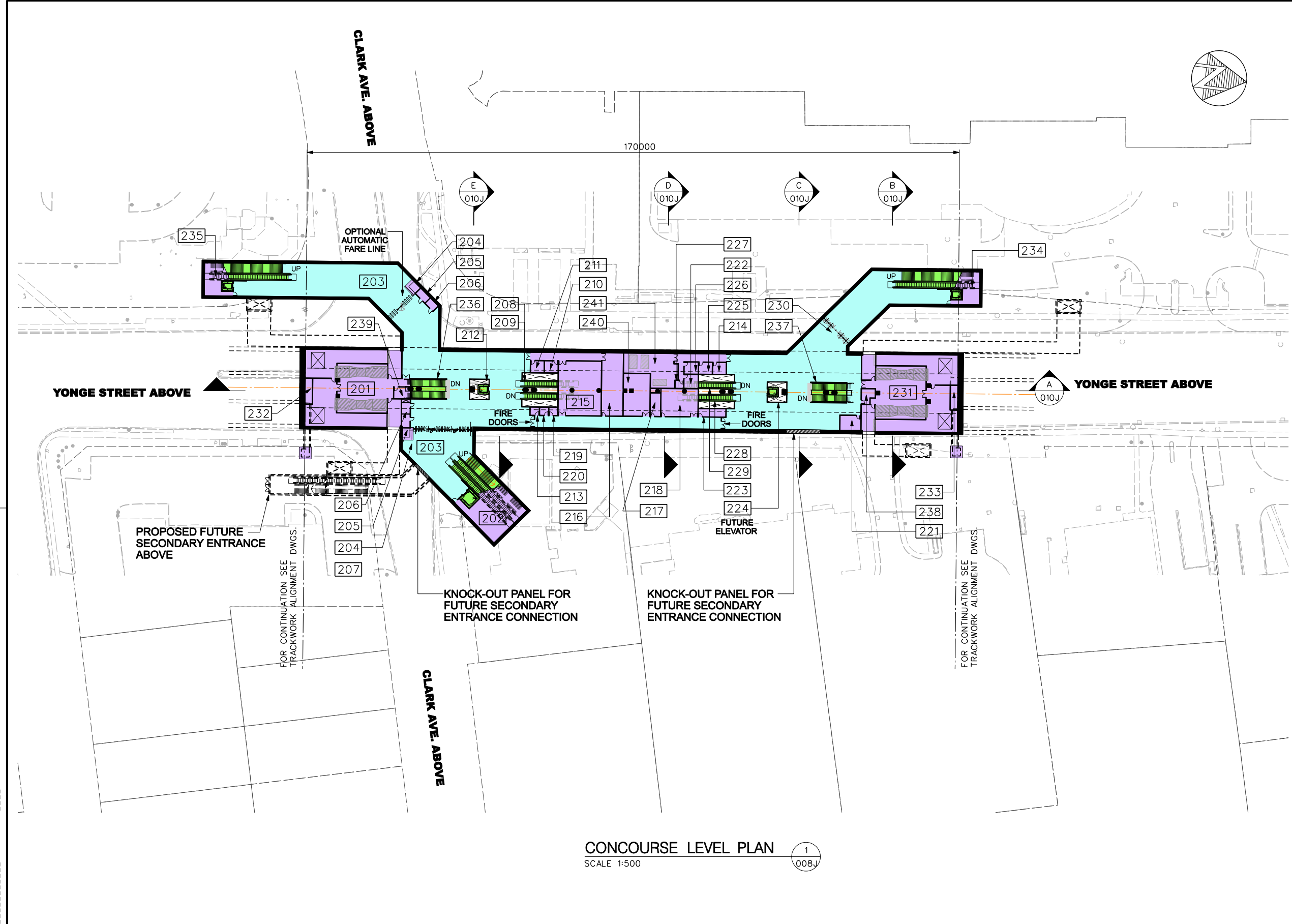

CONCOURSE LEVEL PLAN
SCALE 1:500

ROOM SCHEDULE LEGEND		
RM. No.	ROOM NAME	APPROX. RM. AREA
201	SUBWAY VENTILATION RM.	500
202	ELEV./ESCALATOR MACH. RM.	30
203	FARE LINE	-
204	COLLECTOR'S BOOTH	-
205	COLECTOR'S ANTEROOM	-
206	COLLECTOR'S WASHROOM	-
207	PIPE SPACE	TBD
208	ESCALATOR 5	-
209	ESCALATOR 6	-
210	STAFF WASHROOM FEMALE	10
211	STAFF WASHROOM MALE	10
212	ELEVATOR 4	-
213	STORAGE	4.5
214	VALVE ROOM	10
215	A.C. SWITCHBOARD RM.	145
216	A.C. SWITCHGEAR RM.	85
217	EMERGENCY POWER RM.	15
218	COMM. EQUIPMENT RM.	68
219	JANITOR CLOSET	4
220	JANITOR CHANGE RM.	4
221	FIRE PREVENTION ROOM	20
222	SMART CARD POWER /COMM.	12
223	STORAGE	14
224	FUTURE ELEVATOR 5	-
225	SUMP ROOM	10
226	ELEVATING DEVICE STORAGE	10
227	TELEPHONE EQUIPMENT RM.	4.5
228	ESCALATOR 7	-
229	ESCALATOR 8	-
230	AUTOMATIC FARE LINE	-
231	SUBWAY VENTILATION RM.	500
232	FIRE FIGHTERS ACCESS	15
233	FIRE FIGHTERS ACCESS	15
234	ELEV./ESCALATOR MACH. RM.	30
235	ELEV./ESCALATOR MACH. RM.	30
236	STAIR 4	-
237	STAIR 5	-
238	ELECTRICAL DISTRIBUTION RM.	12
239	ELECTRICAL DISTRIBUTION RM.	12
240	ELECTRICAL HIGH VOLTAGE RM.	70
241	MECHANICAL /HVAC RM.	TBD

LEGEND	
	ROAD
	ELEVATED ROAD
	PUBLIC AREA
	SERVICE ROOMS
	VERTICAL CIRCULATION
	RETAIL
	LANDSCAPE AREA
	NORMAL OPERATION EXIT WAY

DRAWING No. SHEET No. FILE BLDG. REF. No.

REVISIONS	REVISIONS

CONCEPTUAL DESIGN
 NOT FOR CONSTRUCTION

Hatch Mott MacDonald
 MRC McCORMICK RANKIN CORPORATION
A member of MMM GROUP

DRAWN _____
 CHECKED _____
 CORRECT _____
 SCALE

YONGE SUBWAY EXTENSION
CLARK STATION
 CONCOURSE LEVEL

Plot Date: 8/26/2011

 TORONTO TRANSIT COMMISSION
 ENGINEERING DEPARTMENT
 Dwg. No. **SK-A-008J** Sheet No. _____

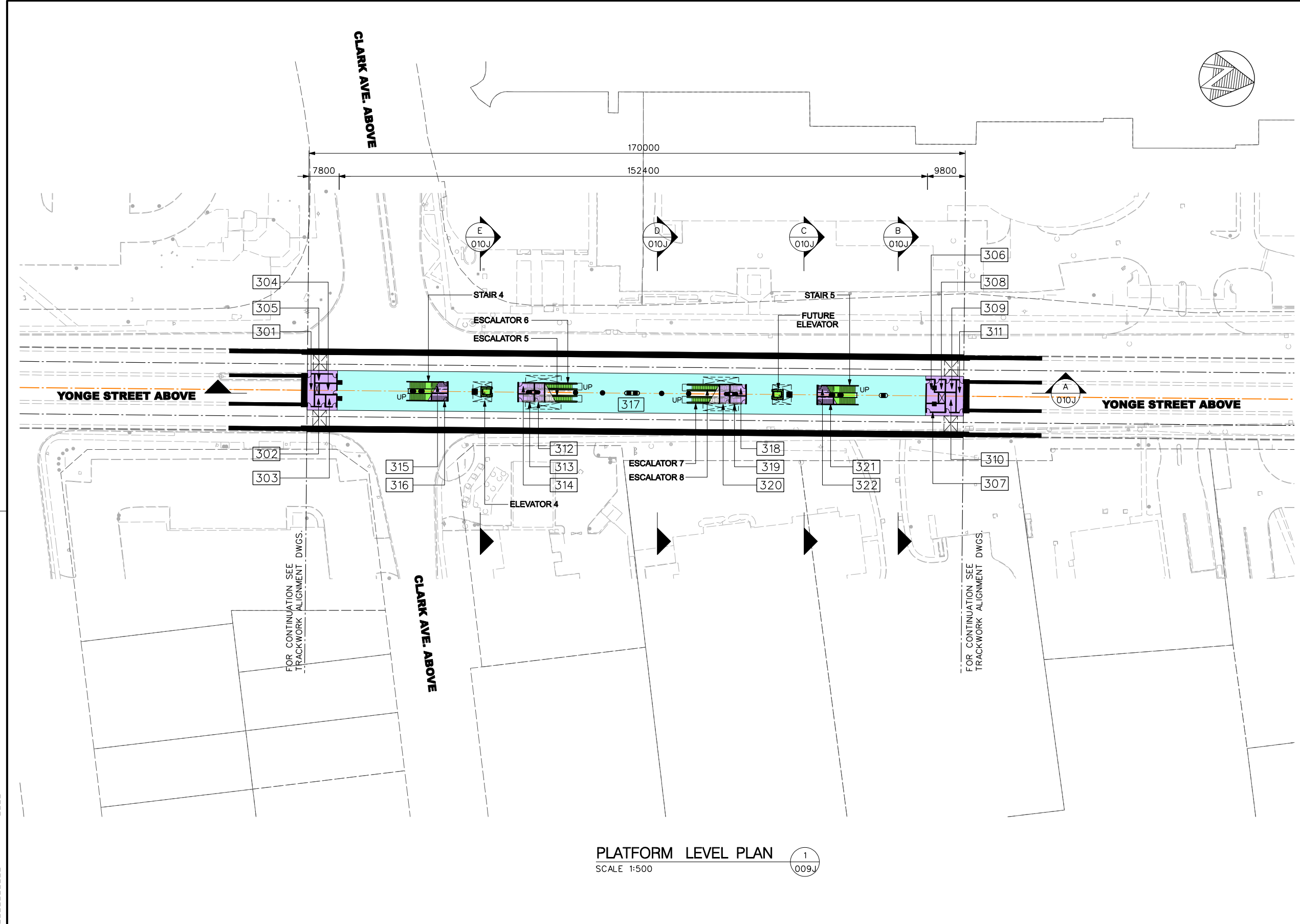

ROOM SCHEDULE LEGEND

RM. No.	ROOM NAME	APPROX. RM. AREA
301	FIRE FIGHTERS ACCESS	12
302	POWER CABLE PULL RM	8
303	SYS. & COMM. CABLE PULL RM	8
304	TRACTION POWER ROOM	12
305	AUXILLARY ELECTRICAL RM.	12
306	AUXILLARY ELECTRICAL RM.	12
307	SUMP PUMP ROOM	10
308	SYS. & COMM. CABLE PULL RM	8
309	POWER CABLE PULL RM	8
310	P.E.D. ROOM (E.R.R.)	12
311	FIRE FIGHTERS ACCESS	15
312	SUMP PUMP ROOM	10
313	ESCALATOR STORAGE ROOM	7.5
314	ESCALATOR SERVICE ROOM	9
315	ELEVATOR MACHINE ROOM	7.3
316	ELEVATOR HVAC ROOM	11
317	SUBWAY PLATFORM	-
318	ESCALATOR SERVICE ROOM	9
319	ESCALATOR STORAGE ROOM	7.5
320	JANITOR SERVICE ROOM	10
321	FUTURE ELEVATOR MACHINE RM.	7.3
322	FUTURE ELEVATOR HVAC RM.	11

LEGEND

- ROAD
- ELEVATED ROAD
- PUBLIC AREA
- SERVICE ROOMS
- VERTICAL CIRCULATION
- RETAIL
- LANDSCAPE AREA
- NORMAL OPERATION EXIT WAY

PLATFORM LEVEL PLAN 1
SCALE 1:500 009J

DRAWING No. SHEET No. FILE BLDG. REF. No.

REVISIONS	REVISIONS

CONCEPTUAL DESIGN
 NOT FOR CONSTRUCTION

Hatch Mott MacDonald
McCORMICK RANKIN CORPORATION
A member of MMM GROUP

DRAWN _____
 CHECKED _____
 CORRECT _____
 SCALE 0 5 10 15 20m

YONGE SUBWAY EXTENSION
CLARK STATION
 PLATFORM LEVEL

Plot Date: 8/26/2011

 TORONTO TRANSIT COMMISSION
 ENGINEERING DEPARTMENT
 Dwg. No. SK-A-009J Sheet No.

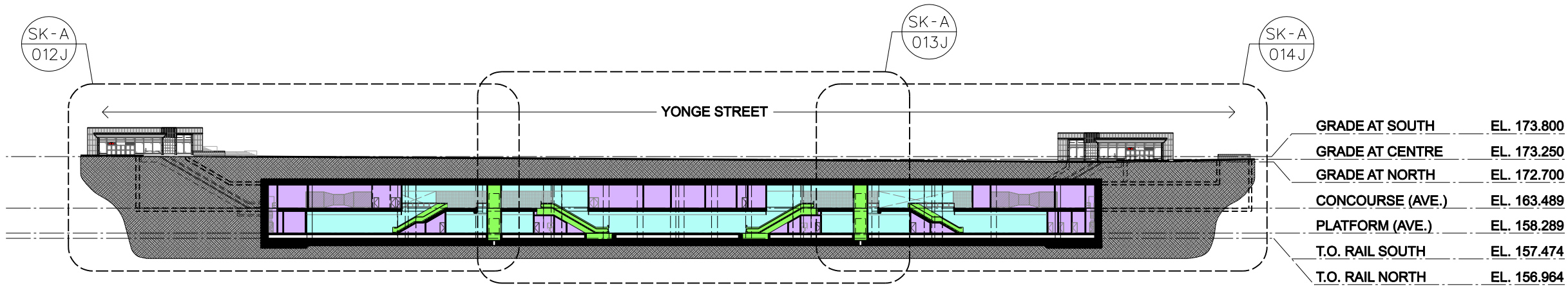

SECTION A-A
SCALE 1:500 LOOKING WEST SK-A-010J

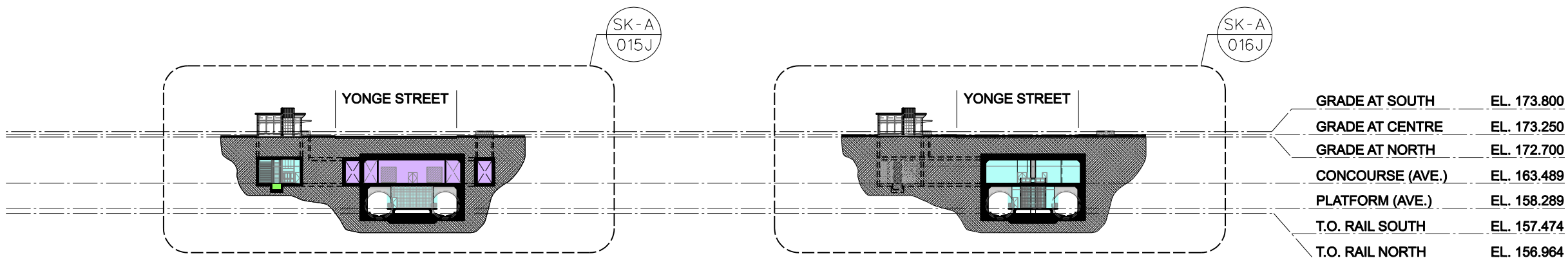

SECTION B-B
SCALE 1:500 LOOKING NORTH SK-A-010J

SECTION C-C
SCALE 1:500 LOOKING NORTH SK-A-010J

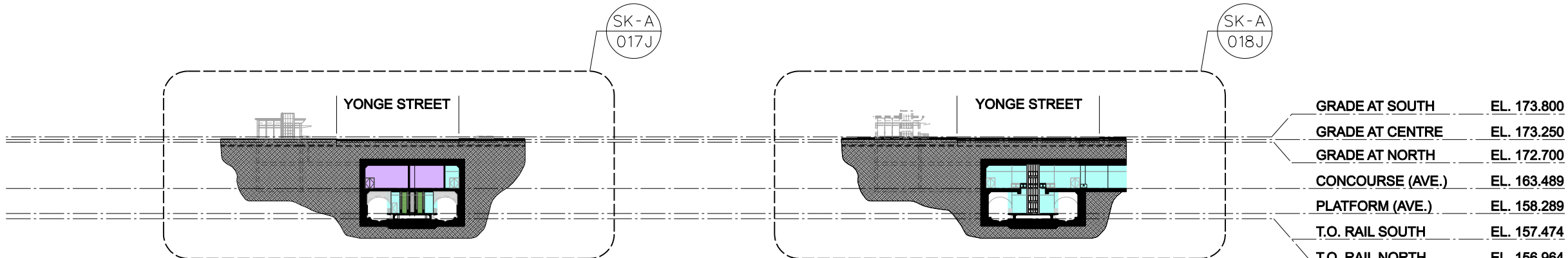

SECTION D-D
SCALE 1:500 LOOKING NORTH SK-A-010J

SECTION E-E
SCALE 1:500 LOOKING NORTH SK-A-010J

LEGEND

	ROAD
	ELEVATED ROAD
	PUBLIC AREA
	SERVICE ROOMS
	VERTICAL CIRCULATION
	RETAIL
	LANDSCAPE AREA
	NORMAL OPERATION EXIT WAY

BLDG. REF. NO.

FILE

SHEET No.

REVISIONS	REVISIONS

CONCEPTUAL DESIGN
NOT FOR CONSTRUCTION

DRAWN _____
CHECKED _____
CORRECT _____
SCALE 0 5 10 15 20m

YONGE SUBWAY EXTENSION
CLARK STATION
OVERALL CROSS SECTIONS

Plot Date: 8/26/2011

TORONTO TRANSIT COMMISSION
ENGINEERING DEPARTMENT
Dwg. No. **SK-A-010J** Sheet No. _____

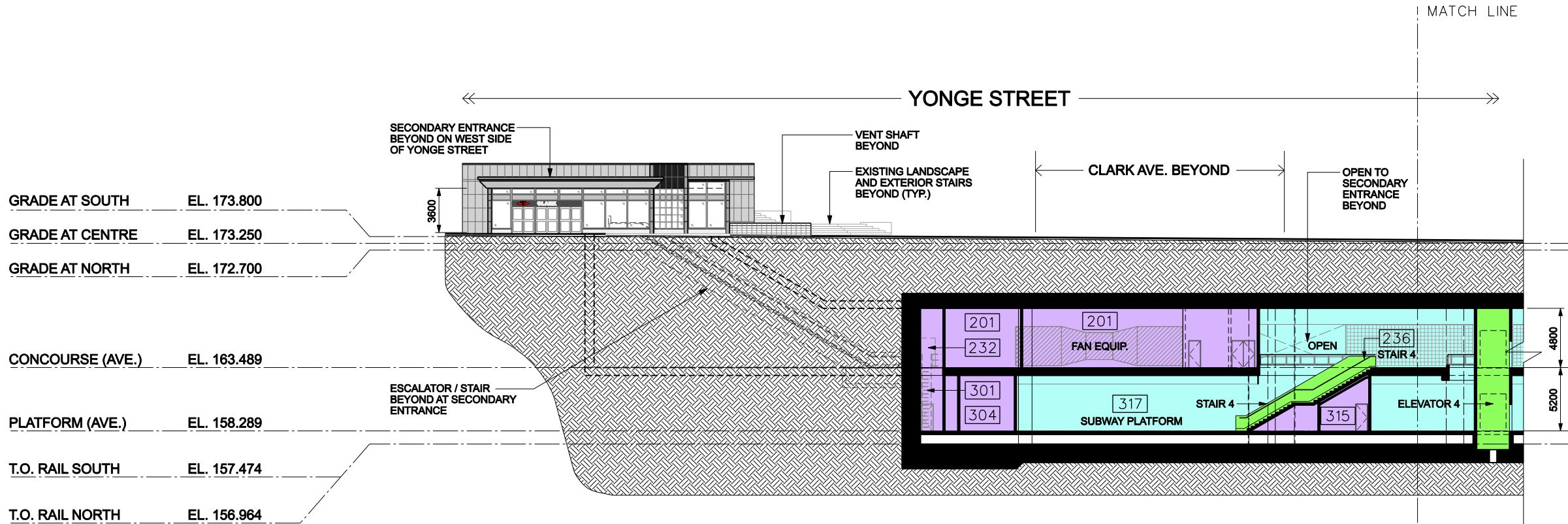

SECTION A-A - SOUTH END
SCALE 1:200
LOOKING WEST
A
SK-A-012J

- LEGEND**
- ROAD
 - ELEVATED ROAD
 - PUBLIC AREA
 - SERVICE ROOMS
 - VERTICAL CIRCULATION
 - RETAIL
 - LANDSCAPE AREA
 - NORMAL OPERATION EXIT WAY

BLDG. REF. NO.
FILE
SHEET No.
DRAWING No.

REVISIONS	REVISIONS

CONCEPTUAL DESIGN
 NOT FOR CONSTRUCTION

DRAWN _____
 CHECKED _____
 CORRECT _____
 SCALE: 0 1 2 3 4 5 8m

YONGE SUBWAY EXTENSION
CLARK STATION
 PART CROSS SECTIONS

Plot Date: 8/26/2011

 TORONTO TRANSIT COMMISSION
 ENGINEERING DEPARTMENT
 Dwg. No. **SK-A-012J** Sheet No. _____

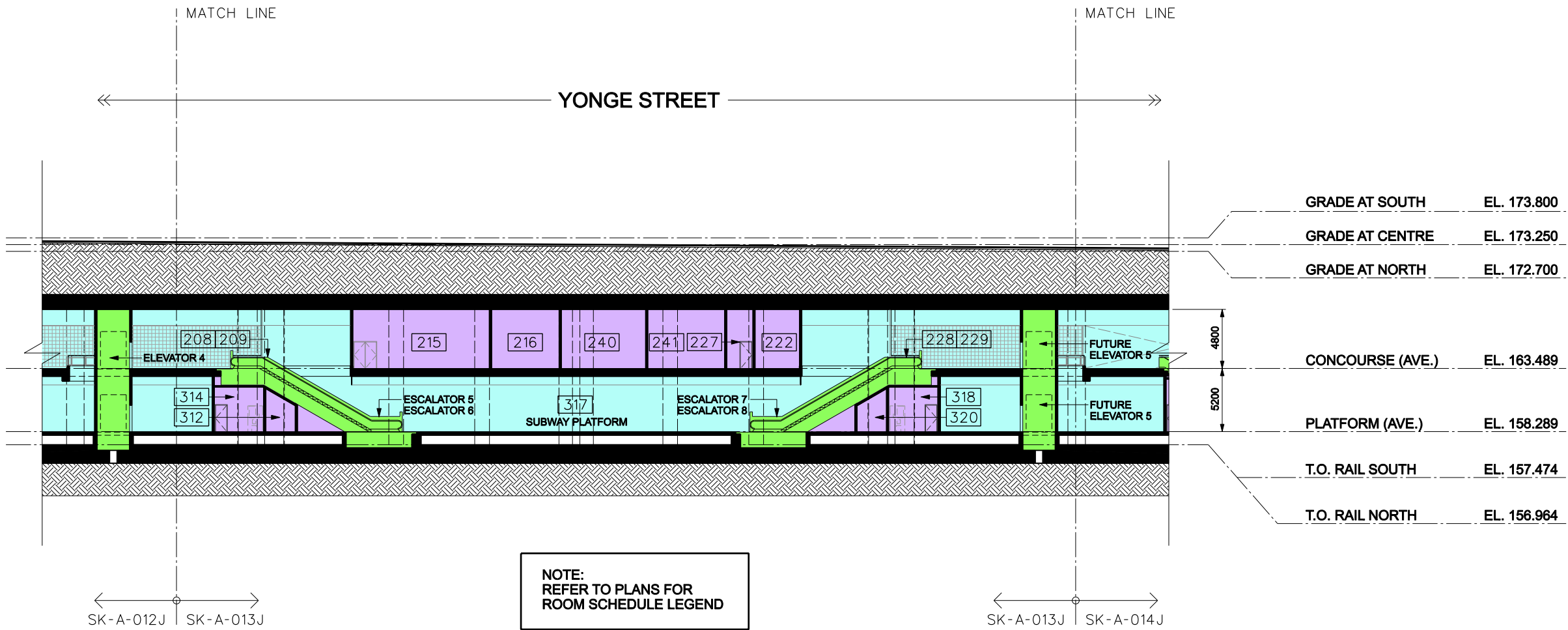

NOTE:
REFER TO PLANS FOR
ROOM SCHEDULE LEGEND

SECTION A-A - CENTRE
SCALE 1:200
LOOKING WEST
A
SK-A-013J

- LEGEND
- ROAD
 - ELEVATED ROAD
 - PUBLIC AREA
 - SERVICE ROOMS
 - VERTICAL CIRCULATION
 - RETAIL
 - LANDSCAPE AREA
 - NORMAL OPERATION EXIT WAY

BLDG. REF. No. FILE SHEET No. DRAWING No.

REVISIONS	REVISIONS

CONCEPTUAL DESIGN
 NOT FOR CONSTRUCTION

DRAWN _____
 CHECKED _____
 CORRECT _____
 SCALE

YONGE SUBWAY EXTENSION
CLARK STATION
 PART CROSS SECTIONS

Plot Date: 8/26/2011

 TORONTO TRANSIT COMMISSION
 ENGINEERING DEPARTMENT
 Dwg. No. **SK-A-013J** Sheet No. _____

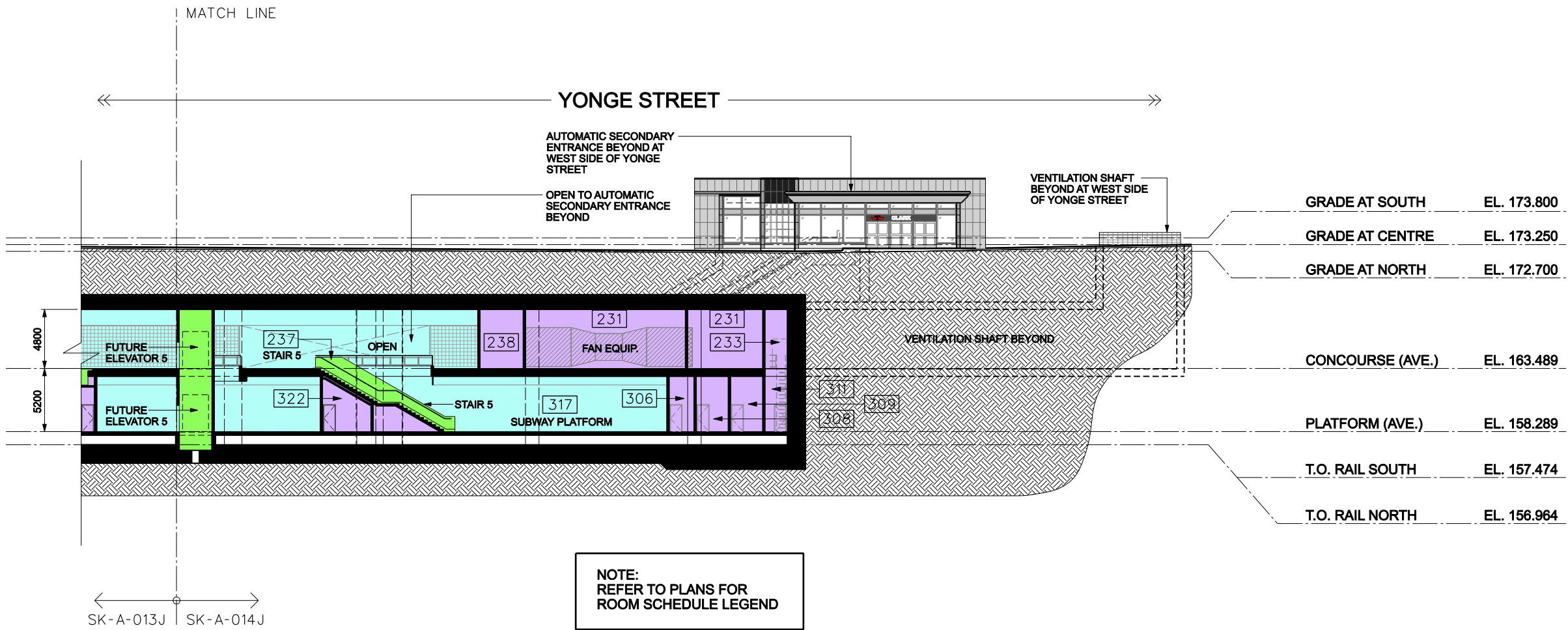

BLDG. REF. No.
 FILE
 SHEET No.
 DRAWING No.

LEGEND

	ROAD
	ELEVATED ROAD
	PUBLIC AREA
	SERVICE ROOMS
	VERTICAL CIRCULATION
	RETAIL
	LANDSCAPE AREA
	NORMAL OPERATION EXIT WAY

REVISIONS	REVISIONS

CONCEPTUAL DESIGN
 NOT FOR CONSTRUCTION

Hatch Mott MacDonald
MRC McCORMICK RANKIN CORPORATION
 A member of MMM GROUP

DRAWN _____
 CHECKED _____
 CORRECT _____
 SCALE: 5m

YONGE SUBWAY EXTENSION
CLARK STATION
 PART CROSS SECTIONS

Plot Date: 8/26/2011

 TORONTO TRANSIT COMMISSION
 ENGINEERING DEPARTMENT
 Dwg. No. **SK-A-014J** Sheet No. _____

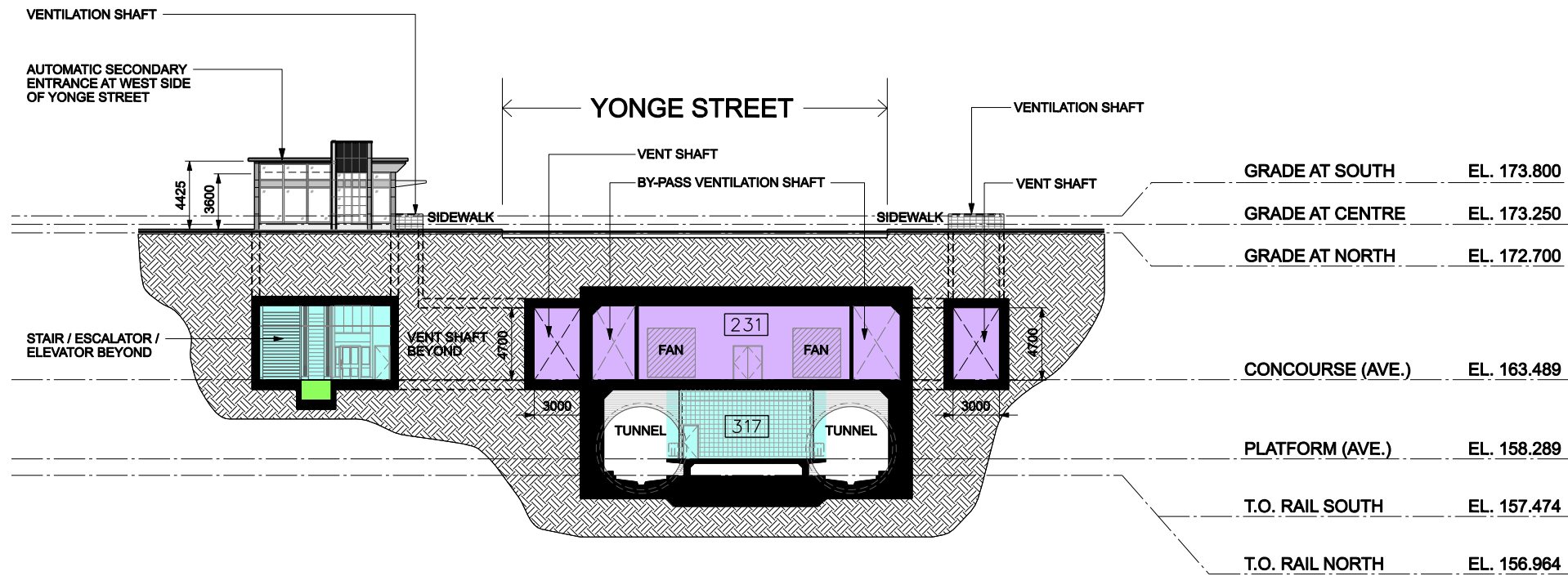

NOTE:
REFER TO PLANS FOR
ROOM SCHEDULE LEGEND

SECTION B-B
SCALE 1:200 LOOKING NORTH A
SK-A-015J

- LEGEND
- ROAD
 - ELEVATED ROAD
 - PUBLIC AREA
 - SERVICE ROOMS
 - VERTICAL CIRCULATION
 - RETAIL
 - LANDSCAPE AREA
 - NORMAL OPERATION EXIT WAY

BLDG. REF. No. FILE SHEET No. DRAWING No.

REVISIONS	REVISIONS
△	△
△	△
△	△

CONCEPTUAL DESIGN
 NOT FOR CONSTRUCTION

DRAWN _____
 CHECKED _____
 CORRECT _____
 SCALE: 5m

YONGE SUBWAY EXTENSION
CLARK STATION
 PART CROSS SECTIONS

Plot Date: 8/26/2011

 TORONTO TRANSIT COMMISSION
 ENGINEERING DEPARTMENT
 Dwg. No. **SK-A-015J** Sheet No. _____

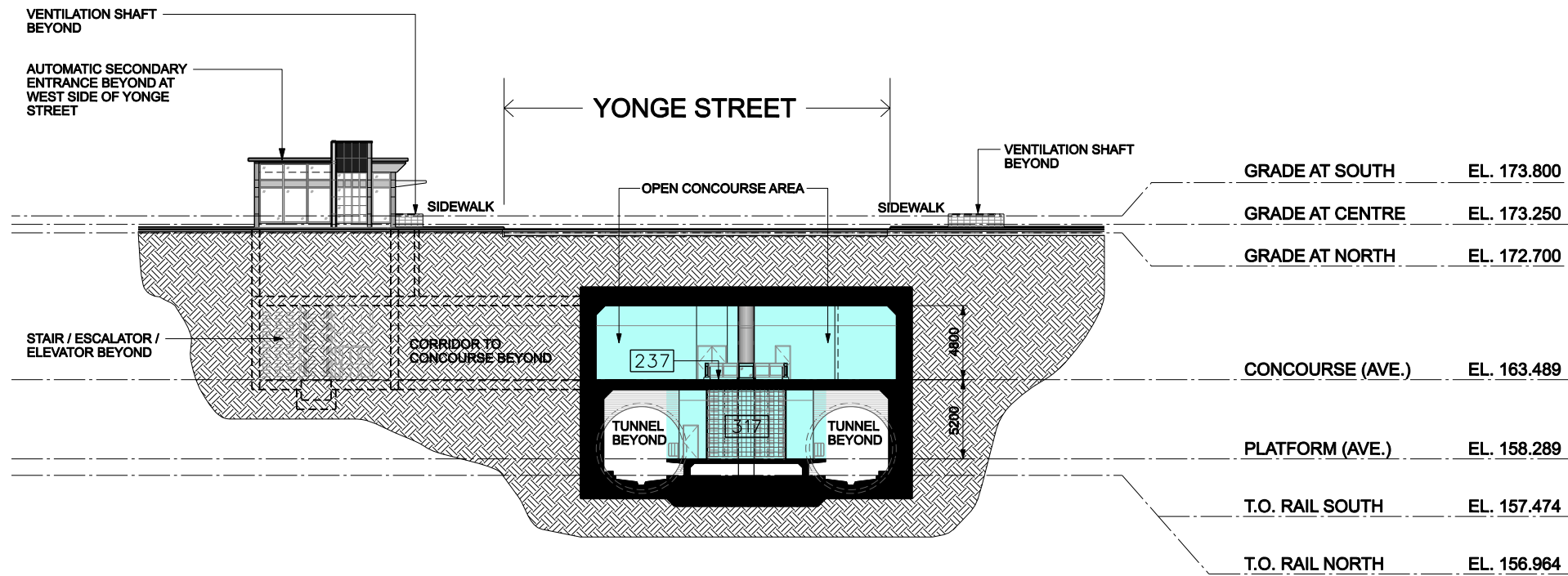

NOTE:
REFER TO PLANS FOR
ROOM SCHEDULE LEGEND

SECTION C-C
SCALE 1:200 LOOKING NORTH A SK-A-016J

- LEGEND**
- ROAD
 - ELEVATED ROAD
 - PUBLIC AREA
 - SERVICE ROOMS
 - VERTICAL CIRCULATION
 - RETAIL
 - LANDSCAPE AREA
 - NORMAL OPERATION EXIT WAY

BLDG. REF. No.
FILE
SHEET No.
DRAWING No.

REVISIONS	REVISIONS

CONCEPTUAL DESIGN
 NOT FOR CONSTRUCTION

DRAWN _____
 CHECKED _____
 CORRECT _____
 SCALE: 5m

YONGE SUBWAY EXTENSION
CLARK STATION
 PART CROSS SECTIONS

Plot Date: 8/26/2011

 TORONTO TRANSIT COMMISSION
 ENGINEERING DEPARTMENT
 Dwg. No. **SK-A-016J** Sheet No. _____

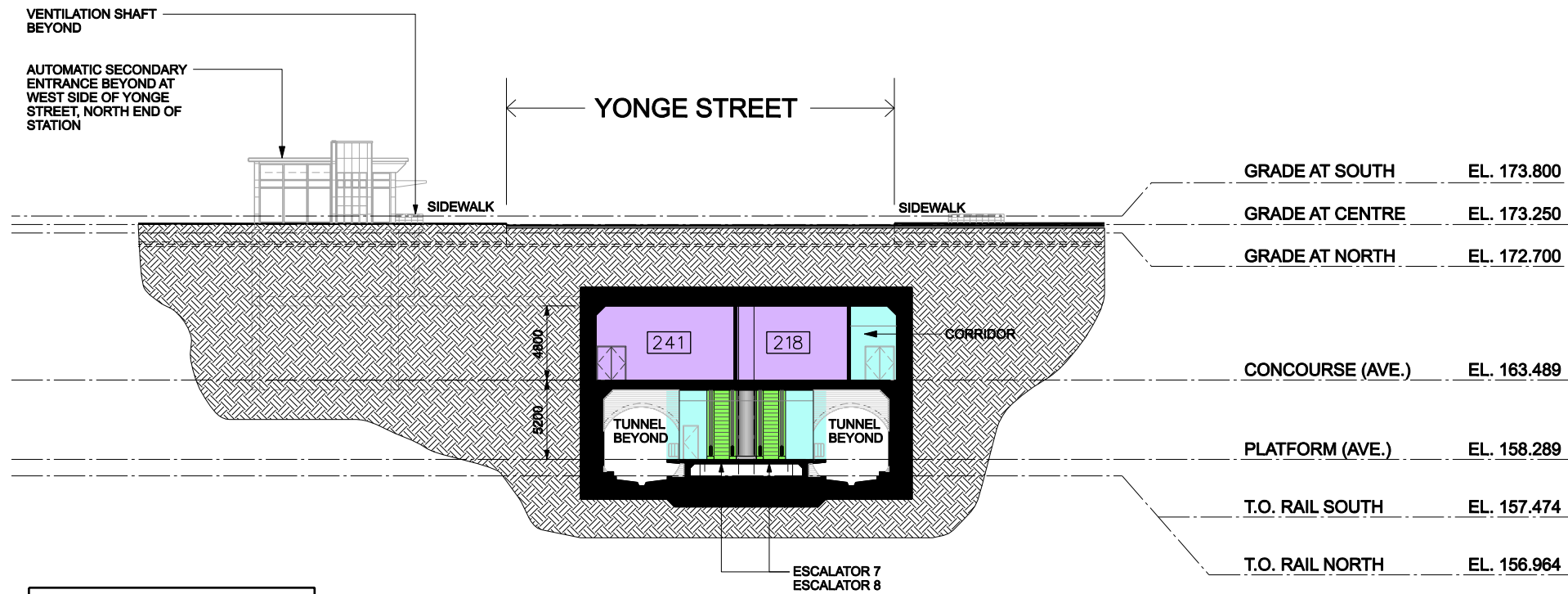

NOTE:
REFER TO PLANS FOR
ROOM SCHEDULE LEGEND

SECTION D-D
SCALE 1:200
LOOKING NORTH
A SK-A-017J

- LEGEND
- ROAD
 - ELEVATED ROAD
 - PUBLIC AREA
 - SERVICE ROOMS
 - VERTICAL CIRCULATION
 - RETAIL
 - LANDSCAPE AREA
 - NORMAL OPERATION EXIT WAY

BLDG. REF. No.
FILE
SHEET No.
DRAWING No.

REVISIONS	REVISIONS

CONCEPTUAL DESIGN
 NOT FOR CONSTRUCTION

DRAWN _____
 CHECKED _____
 CORRECT _____
 SCALE

YONGE SUBWAY EXTENSION
CLARK STATION
 PART CROSS SECTIONS

Plot Date: 8/26/2011

 TORONTO TRANSIT COMMISSION
 ENGINEERING DEPARTMENT
 Dwg. No. **SK-A-017J** Sheet No. _____

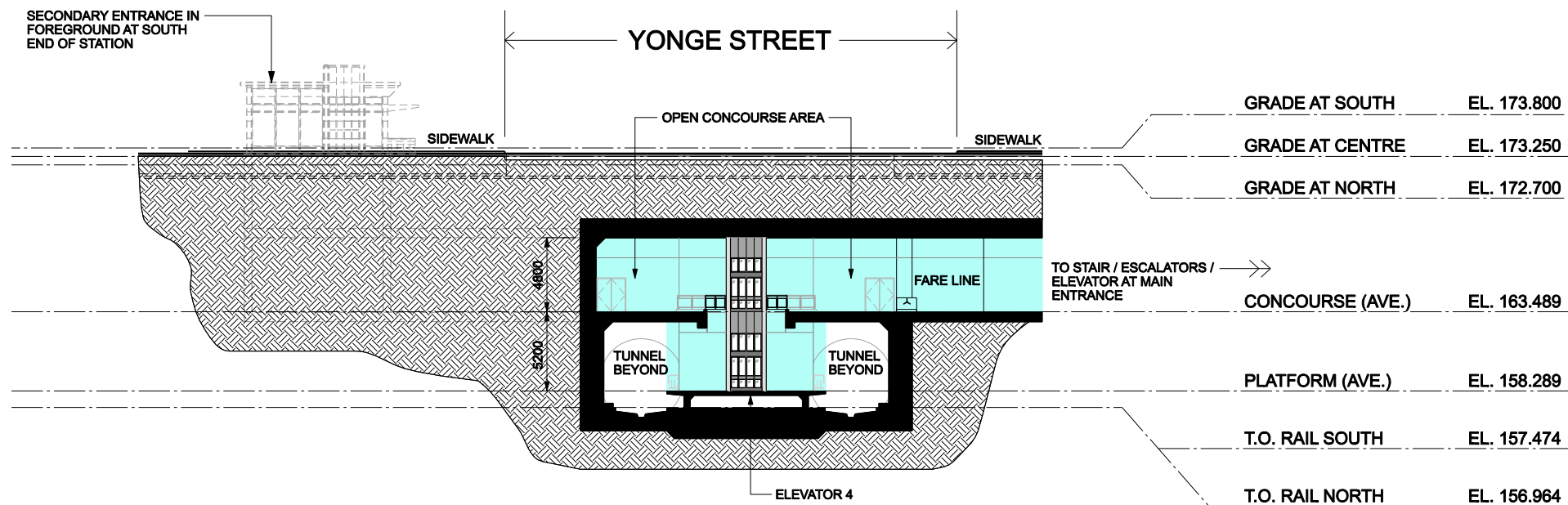

NOTE:
REFER TO PLANS FOR
ROOM SCHEDULE LEGEND

SECTION E-E
SCALE 1:200
LOOKING NORTH
A SK-A-018J

- LEGEND
- ROAD
 - ELEVATED ROAD
 - PUBLIC AREA
 - SERVICE ROOMS
 - VERTICAL CIRCULATION
 - RETAIL
 - LANDSCAPE AREA
 - NORMAL OPERATION EXIT WAY

BLDG. REF. No.
FILE
SHEET No.
DRAWING No.

REVISIONS	REVISIONS

CONCEPTUAL DESIGN
 NOT FOR CONSTRUCTION

DRAWN _____
 CHECKED _____
 CORRECT _____
 SCALE:

YONGE SUBWAY EXTENSION
CLARK STATION
 PART CROSS SECTIONS

Plot Date: 8/26/2011

 TORONTO TRANSIT COMMISSION
 ENGINEERING DEPARTMENT
 Dwg. No. **SK-A-018J** Sheet No. _____

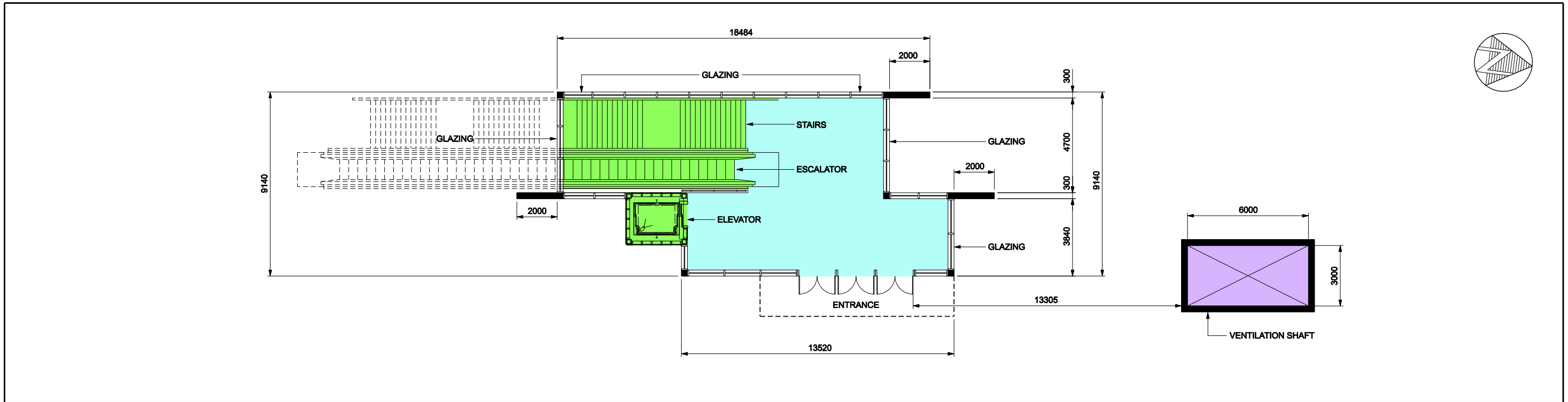

AUTOMATIC ENTRANCE PLAN
SCALE 1:100

1
019J

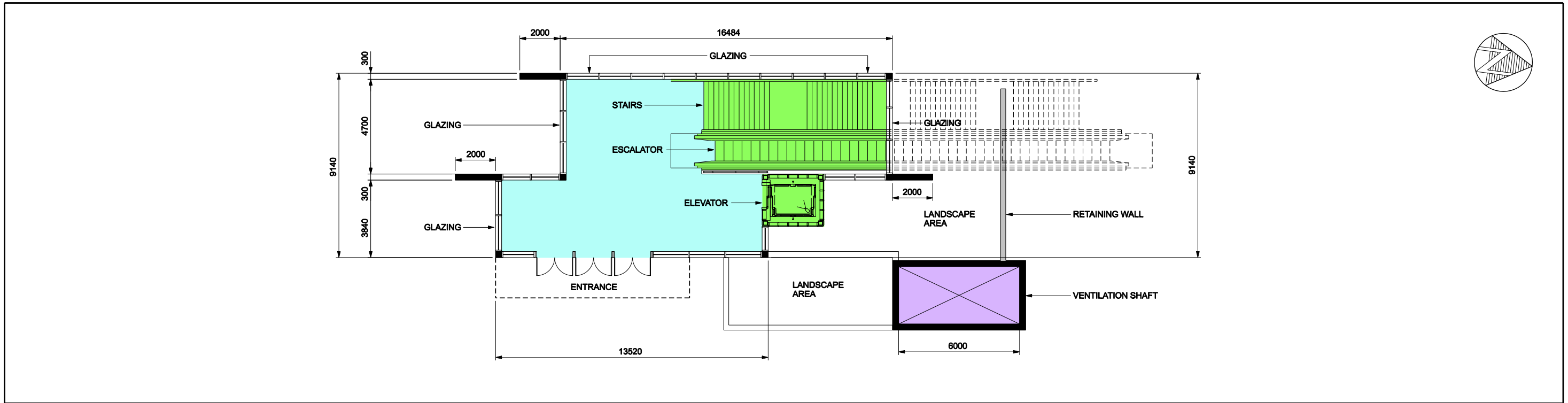

SECONDARY ENTRANCE PLAN
SCALE 1:100

2
019J

BLDG. REF. No.

FILE

SHEET No.

DRAWING No.

REVISIONS	REVISIONS

CONCEPTUAL DESIGN
NOT FOR CONSTRUCTION

Hatch Mott MacDonald

MRC McCORMICK RANKIN CORPORATION
A member of **MMM GROUP**

DRAWN _____
CHECKED _____
CORRECT _____

SCALE
0 1 2 3 4m

YONGE SUBWAY EXTENSION

CLARK STATION
STREET LEVEL - ENTRANCES

Plot Date: 8/26/2011

TORONTO TRANSIT COMMISSION
ENGINEERING DEPARTMENT

Dwg. No. **SK-A-019J** Sheet No. _____

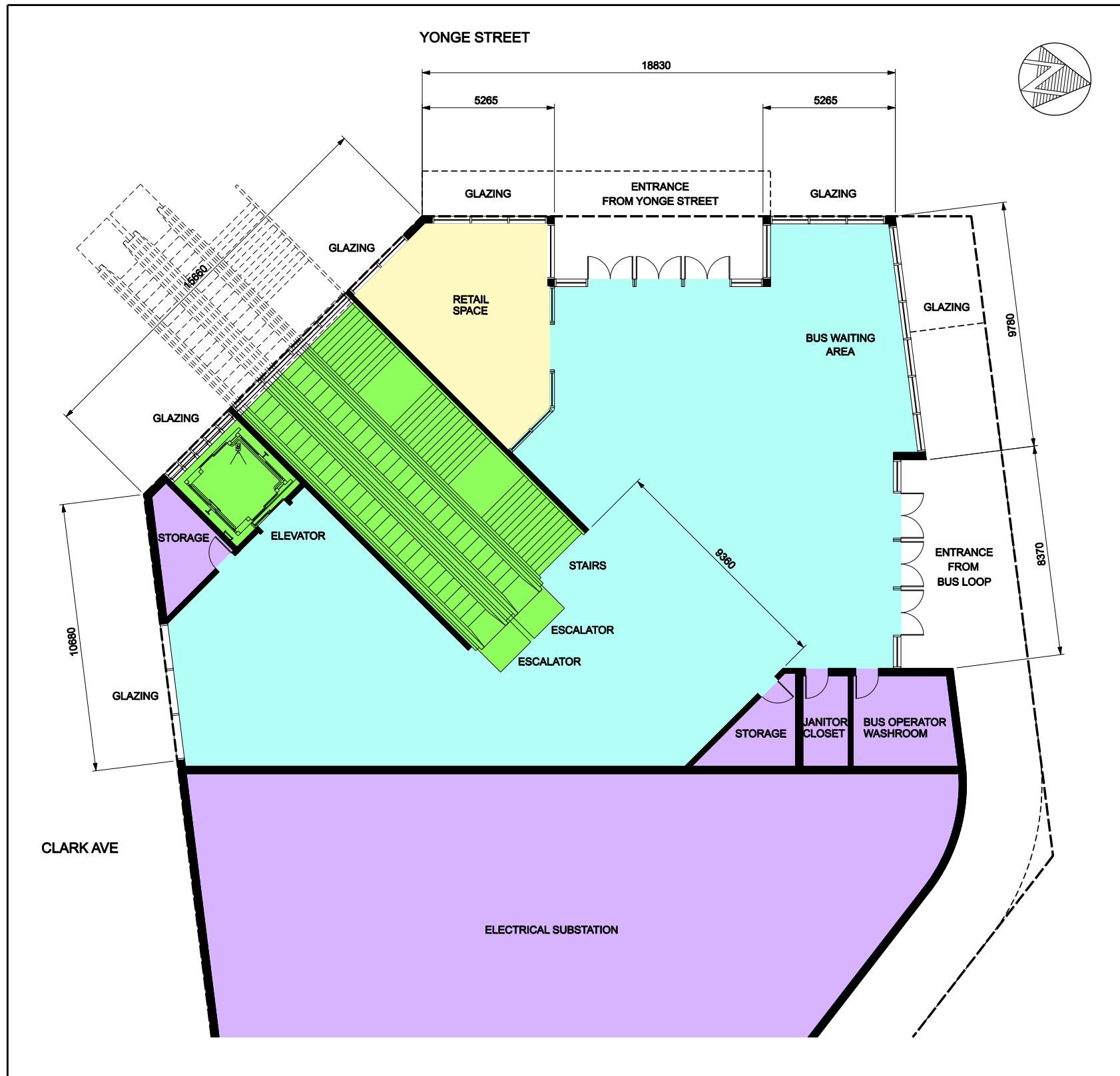

MAIN ENTRANCE PLAN

SCALE 1:100

1
020J

DRAWING No. SHEET No. FILE BLDG. REF. No.

REVISIONS	REVISIONS

CONCEPTUAL DESIGN
 NOT FOR CONSTRUCTION

 Hatch Mott MacDonald
 MRC McCormick Rankin Corporation
A member of MMM GROUP

DRAWN
 CHECKED
 CORRECT
 SCALE

YONGE SUBWAY EXTENSION
CLARK STATION
 STREET LEVEL - ENTRANCES

Plot Date: 8/26/2011

 TORONTO TRANSIT COMMISSION
 ENGINEERING DEPARTMENT
 Dwg. No. SK-A-020J Sheet No.

10. LANGSTAFF STATION

Langstaff Station is located under Yonge Street between Longbridge Road and Langstaff Road. The station's zone of influence would cover an area bounded approximately by Riverside Boulevard to the west, Ruggles Avenue to the east, Uplands Avenue to the south, and Highway 407 to the north. This station would be adjacent to the Langstaff Gateway transit dependent development area in the Town of Markham, as well as the Richmond Hill/Langstaff Gateway Urban Growth Centre which has been designated as a Mobility Hub by Metrolinx.

A commuter park and ride (1,800-2,200 spaces) and a passenger pick-up and drop-off facility is provided on the west side of the station. One of the station entrances will be located at the south end of the station on the west side of Yonge Street to service the commuter parking riders. Another entrance will be located at the north end of the station on the east side of Yonge Street to service the proposed high density transit dependent Langstaff Gateway lands.

Key station features are as follows:

- Future transit-oriented redevelopment on the east side of Yonge Street within the Langstaff Gateway development site
- Future transit-oriented redevelopment on the west side of Yonge Street
- Commuter park-and-ride lot and passenger pick-up/drop-off facilities within the Hydro Corridor

Descriptions on the proposed design for Langstaff Station are summarized in the following sections.

10.1 Passenger Transfer Movements

The passenger transfer movements at Langstaff Station were estimated based on the passenger demand forecast analysis described in Section 2 and Appendix 'A' of this report. A breakdown of the forecast 2031 AM peak hour transfer movements by mode and by direction can be found in **Table 10-1**.

Table 10-1: Estimated Passenger Transfer Movements at Langstaff Station (2031)

AM Peak Hour		OUT OF STATION			
TRANSFERS		SUBWAY		WALK OUT	TOTAL
INTO STATION	DIR	NB	SB		
SUBWAY	NB	0	0	200	200
	SB	0	0	10	10
PARK'N'RIDE		0	1750	0	1750
WALK IN		80	220	0	300
TOTAL		80	1970	210	2260

As shown in Table 9-7, transfer movements at Langstaff Station are predominantly between the commuter park-and-ride lot and the subway. Of the total 2,260 AM peak hour passenger movements projected at Langstaff Station, about 77% (1,750) are between the park-and-ride lot and the subway while the remaining 23% (510) are between the subway and walk-in/out. As previously noted, the estimated passengers are

expected to increase as the connections between the Langstaff Gateway lands and the subway station improve.

Passenger flow diagrams prepared for Langstaff Station can be found in Appendix 'E' of this report.

10.2 Station Entrances

One of the station entrances is located on the west side of Yonge Street between Longbridge Road and the exit ramp from eastbound Highway 407. Another entrance is located on the east side of Yonge Street just south of Langstaff Road East and will provide direct connection to proposed TOD within the Langstaff Gateway lands.

The west entrance is fully accessible with an elevator, two escalators, and stairs. The east entrance has been designed with two escalators, stairs, and provision for future installation of a second elevator route. We recommend that the structural elements of all elevators be built in order to reduce the initial capital cost and impact of adding these vertical circulation elements in the future. As development occurs to the east of the station, it is anticipated that the initial entrance building will be integrated into TOD and that extensions of the underground connection to the concourse could be extended further into the development.

10.3 Street Level

Emergency ventilation shafts are located on both sides of Yonge Street south of the intersection with the Highway 407 Exit Ramp and Langstaff Road East. At the south end of the station, both vent shafts will be located on the west side of Yonge Street – one north of Longbridge Road and one to the south. Note that additional station ventilation shafts are required for normal exhaust and makeup air to staffed spaces below grade, and will be sized and located in the next phase of design.

Fire Fighter's Access shafts are located; one on the west side of Yonge Street south of the 407 Exit Ramp, and one on the west side of Yonge Street just south of the cemetery entrance.

10.4 Concourse Level

In order to reduce the station box length, utility rooms have been located at concourse level thus dividing the concourse in two. This layout also provides the fire separation for two egress routes required under OBC 3.13 from platform to surface. A public passageway connects the two areas on the west side of the concourse with two sets of fire doors. It is likely that this corridor will also require sprinklers to meet code requirements. Emergency ventilation fans are also located at concourse level, with two fan assemblies located at each end of the station box.

Entering the concourse from the Main Entrance, passengers move past the Collector's Booth and through a low gate fare array. Moving through the fare line, passengers have two escalators, a set of stairs and an elevator down to platform. Entering the concourse from the Automatic Entrance, passengers move through a high gate fare array, with provision for future installation of an Easier Access Portal Unit (EAPU), and then have two escalators and a set of stairs providing access to the platform. Provision has also been made for installation of a future elevator from the north concourse to the platform.

10.5 Platform Level

Passengers move between concourse and platform using four escalators, two sets of stairs, and an elevator. Provision has been made for the addition of a second elevator route through the north concourse. Vertical circulation has been designed to accommodate both normal and emergency passenger loads using the normal vertical circulation elements. This is our preferred design approach, as observation has shown that in emergencies, people tend to follow familiar routes out of buildings rather than follow emergency exits routes.

10.6 Commuter Parking and Passenger Pick-Up/Drop-Off

The design of the commuter parking lot and the Passenger Pick-Up/Drop-Off (PPUDO) has been advanced to provide new stormwater management ponds required as part of the stormwater management strategy for the site. Layout of the parking lot (including the PPUDO), noise attenuation measures, as well as sustainable design features will be determined as part of the next stage of design. Future work should be carried out in consultation with the local community, the Holy Cross Cemetery, and all affected municipal and technical stakeholders.

10.7 Drainage and Stormwater Management

As part of the Conceptual Design Study, a preliminary drainage and stormwater management analysis was carried out on the site of the commuter parking lot. The purpose of the analysis was to investigate the drainage pattern on site under current (green field) and future (parking lot) conditions, as well as to develop a preliminary stormwater management strategy for controlling surface runoff from the parking lot. A detailed description of the analysis can be found in **Appendix 'G'** of this report.

The site is elongated in an east west direction with a drainage divide situated near the middle of the site. Under existing conditions, the east half of the site drains to Pomona Mills Creek and the west half drains to the East Don River. The site is an open space land with thick bushes located under the Hydro One transmission lines. To maintain the existing drainage patterns, approximately one half of the proposed parking lot will drain west to the East Don River and the remaining half of the parking lot will drain east to Pomona Mills Creek.

The stormwater management strategy proposed for the site includes two stormwater management (SWM) ponds, vegetated filter strips, enhanced grassed swales, bio retention trenches, and an exfiltration system in addition to Goss Traps at the catchbasins. The two SWM ponds will service the parking lot, providing erosion control, quantity control, and quality treatment for the runoff draining from the parking lot.

The West SWM Pond will service approximately one half of the parking lot and the East SWM Pond will service the remaining half of the parking lot. The West SWM Pond will control the outflows from the pond to less than the allowable flow rates to the East Don River. The East SWM Pond will control the outflows from the pond to less than the allowable flow rates to Pomona Mills Creek. Due to elevation constraint, the runoff from the access road to the parking lot and passenger drop off area (Catchment 230) cannot be conveyed to the East SWM Pond to provide quantity control, and it does not appear to be feasible to construct a second pond in the area. The controlled outflows from the pond plus the uncontrolled flows from Catchment 230 will exceed the allowable flow rates to Pomona Creek. Additional retention measures and consultation with TRCA during subsequent stages of design will be required.

Low Impact Development measures such as vegetated filter strips, enhanced grassed swales, and bio retention trenches are proposed to provide additional measures of water quality treatment. A treatment train approach was designed where feasible. Bio retention trenches and an exfiltration system are proposed to meet the water balance requirements, where a minimum of 5 mm of runoff must be retained from the site.

10.8 Utilities and Relocation Strategy

There are no significant utilities that cannot be temporarily or permanently relocated for the station construction.

10.9 Archaeological Assessment

The Stage 1 Archaeological Assessment carried out as part of the Yonge Subway Extension TPAP identified parcels within the station area with archaeological potential that may be impacted by the planned commuter park-and-ride lot and station entrance building at Langstaff Station. As such, a Stage 2 Archaeological Assessment (Property Assessment) was carried out on these lands as part of the Conceptual Design assignment. In spite of a comprehensive test pit survey at 5 metre intervals, no archaeological resources were recovered on the subject lands. As such, these lands previously determined to have archaeological potential can be considered clear of archaeological concern, and no further archaeological assessment is required. Details on the Stage 2 Archaeological Assessment can be found in Appendix 'D' of this report.

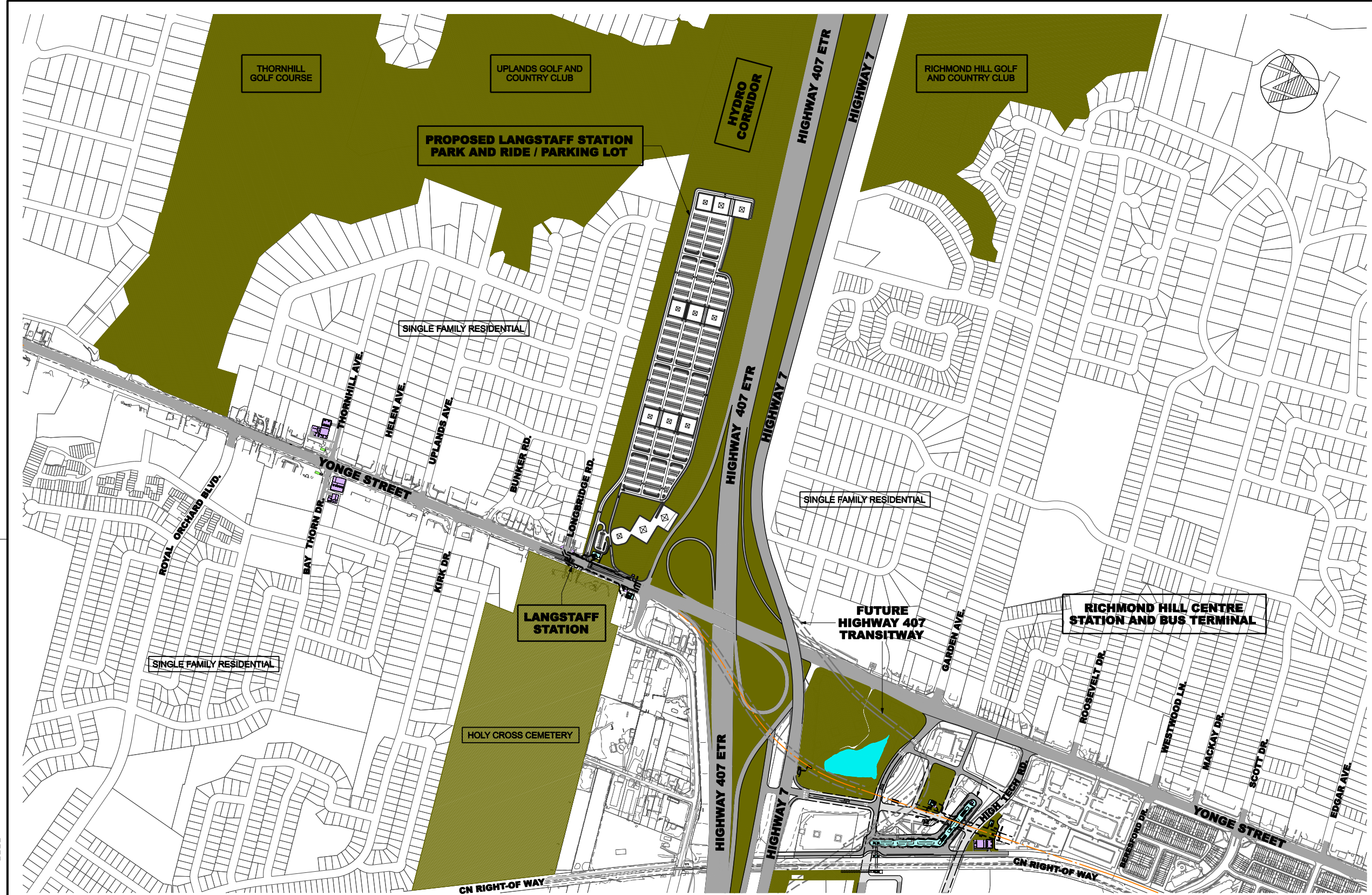

- LEGEND**
- ROAD
 - ELEVATED ROAD
 - PUBLIC AREA
 - SERVICE ROOMS
 - VERTICAL CIRCULATION
 - RETAIL
 - LANDSCAPE AREA
 - NORMAL OPERATION EXIT WAY

LOCATION PLAN
SCALE 1:5000

DRAWING No. SHEET No. FILE BLDG. REF. No.

REVISIONS	REVISIONS

CONCEPTUAL DESIGN
NOT FOR CONSTRUCTION

Hatch Mott MacDonald
MRC McCORMICK RANKIN CORPORATION
A member of MMM GROUP

DRAWN _____
CHECKED _____
CORRECT _____
SCALE 0 100 200m

YONGE SUBWAY EXTENSION
LANGSTAFF STATION
LOCATION PLAN

Plot Date: 8/26/2011

TORONTO TRANSIT COMMISSION
ENGINEERING DEPARTMENT

Dwg. No. **SK-A-001E** Sheet No. _____

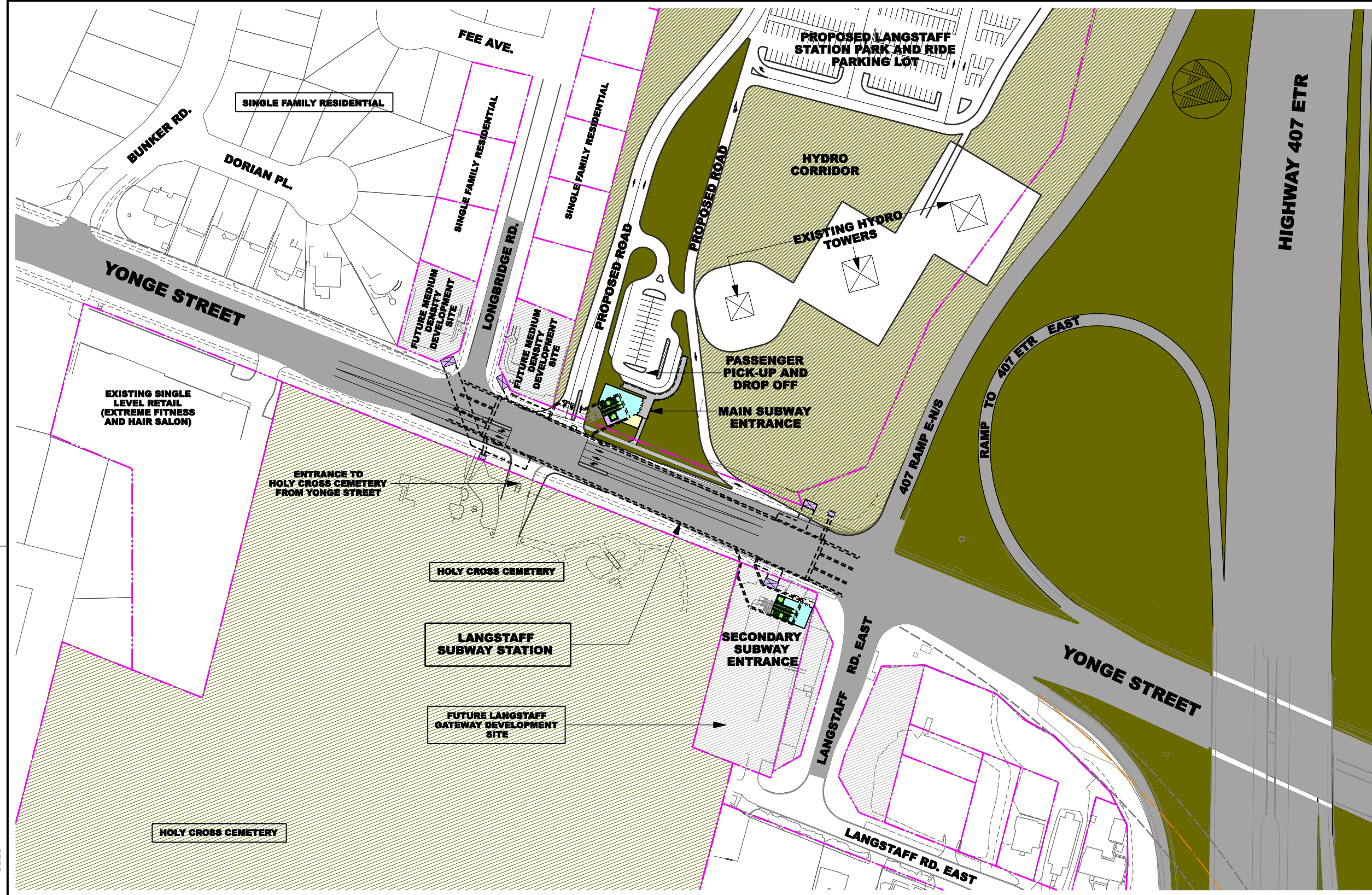

- LEGEND**
- ROAD
 - ELEVATED ROAD
 - PUBLIC AREA
 - SERVICE ROOMS
 - VERTICAL CIRCULATION
 - RETAIL
 - LANDSCAPED AREA
 - NORMAL OPERATION EXIT WAY

SITE PLAN
1:1000

DRAWING No. SHEET No. FILE BLDG. REF. No.

REVISIONS	REVISIONS

CONCEPTUAL DESIGN
 NOT FOR CONSTRUCTION

DRAWN _____
 CHECKED _____
 CORRECT _____
 SCALE: 0 10 20 30 40m

YONGE SUBWAY EXTENSION
LANGSTAFF STATION
 SITE PLAN

Plot Date: 8/26/2011

 TORONTO TRANSIT COMMISSION
 ENGINEERING DEPARTMENT
 Dwg. No. SK-A-002E
 Sheet No.

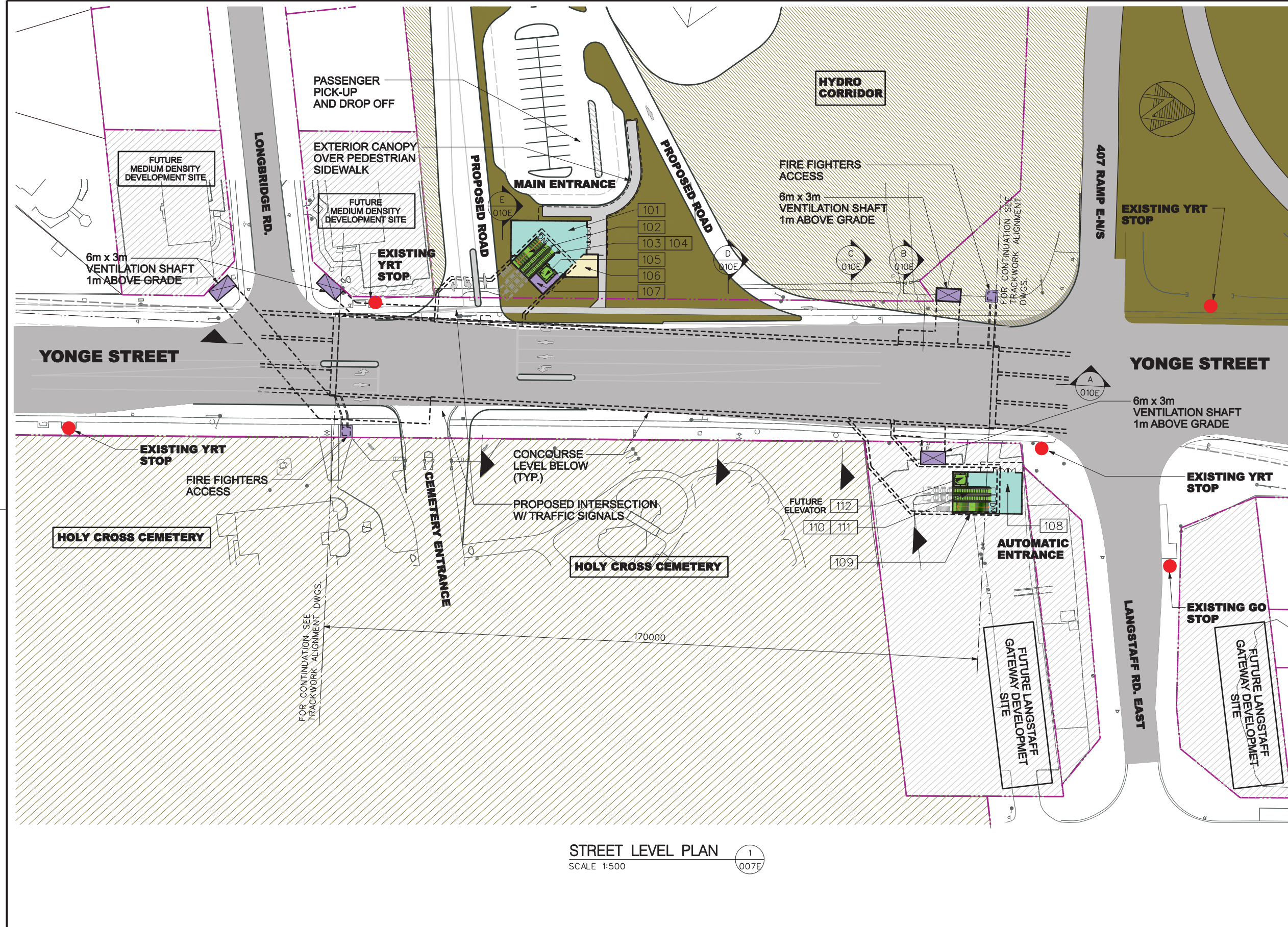

ROOM SCHEDULE LEGEND		
RM. No.	ROOM NAME	APPROX. RM. AREA
101	MAIN SUBWAY ENTRANCE	180
102	STAIR 1	-
103	ESCALATOR 1	-
104	ESCALATOR 2	-
105	ELEVATOR 1	-
106	RETAIL	35
107	STORAGE	16
108	SECONDARY ENTRANCE	105
109	STAIR 2	-
110	ESCALATOR 3	-
111	ESCALATOR 4	-
112	FUTURE ELEVATOR 2	-

LEGEND	
	ROAD
	ELEVATED ROAD
	PUBLIC AREA
	SERVICE ROOMS
	VERTICAL CIRCULATION
	RETAIL
	LANDSCAPE AREA
	NORMAL OPERATION EXIT WAY

STREET LEVEL PLAN
SCALE 1:500

DRAWING No. SHEET No. FILE BLDG. REF. No.

REVISIONS	REVISIONS

CONCEPTUAL DESIGN
 NOT FOR CONSTRUCTION

Hatch Mott MacDonald
 MRC McCORMICK RANKIN CORPORATION
A member of MMM GROUP

DRAWN _____
 CHECKED _____
 CORRECT _____
 SCALE 0 5 10 15 20m

YONGE SUBWAY EXTENSION
LANGSTAFF STATION
 STREET LEVEL

Plot Date: 8/26/2011

 TORONTO TRANSIT COMMISSION
 ENGINEERING DEPARTMENT
 Dwg. No. SK-A-007E Sheet No.

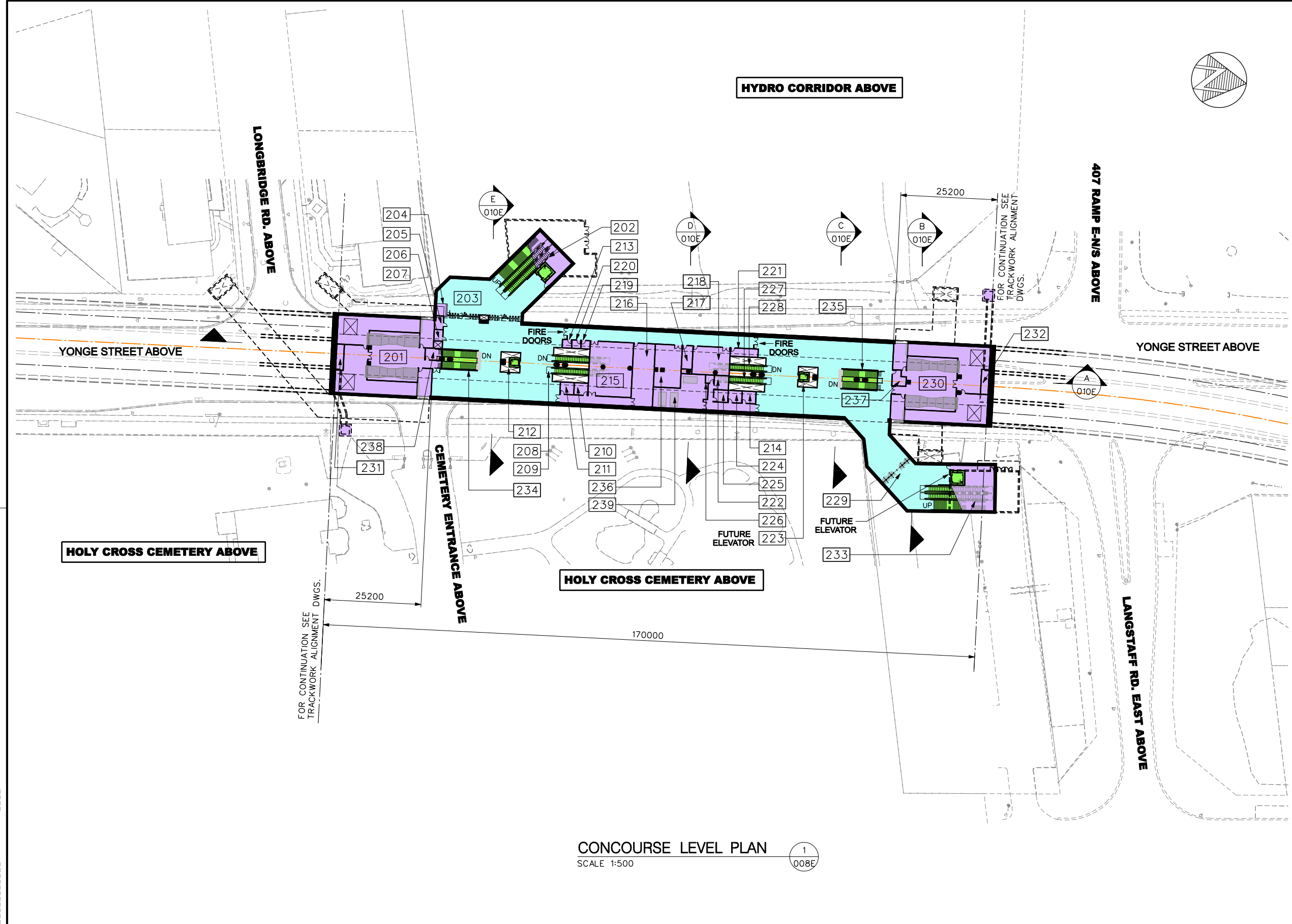

CONCOURSE LEVEL PLAN
SCALE 1:500

ROOM SCHEDULE LEGEND		
RM. No.	ROOM NAME	APPROX. RM. AREA
201	SUBWAY VENTILATION RM.	500
202	ELEV./ESCALATOR MACH. RM.	-
203	FARE LINE	-
204	COLLECTOR'S BOOTH	-
205	COLLECTOR'S ANTEROOM	-
206	COLLECTOR'S WASHROOM	-
207	PIPE SPACE	TBD
208	ESCALATOR 5	-
209	ESCALATOR 6	-
210	STAFF WASHROOM FEMALE	10
211	STAFF WASHROOM MALE	10
212	ELEVATOR 3	-
213	STORAGE	4.5
214	VALVE ROOM	10
215	A.C. SWITCHBOARD RM.	145
216	A.C. SWITCHGEAR RM.	85
217	EMERGENCY POWER RM.	15
218	COMM. EQUIPMENT RM.	68
219	JANITOR CLOSET	4
220	JANITOR CHANGE RM.	4
221	MECHANICAL/HVAC MAINT. SHOP	14
222	SMART CARD POWER /COMM.	12
223	FUTURE ELEVATOR 4	-
224	SUMP ROOM	10
225	ELEVATING DEVICE STORAGE	10
226	TELEPHONE EQUIPMENT RM.	4.5
227	ESCALATOR 7	-
228	ESCALATOR 8	-
229	AUTOMATIC FARE LINE	-
230	SUBWAY VENTILATION RM.	500
231	FIRE FIGHTERS ACCESS	-
232	FIRE FIGHTERS ACCESS	-
233	ELEV./ESCALATOR MACH. RM.	-
234	STAIR 3	-
235	STAIR 4	-
236	ELECTRICAL HIGH VOLTAGE RM.	70
237	ELECTRICAL DISTRIBUTION RM.	12
238	ELECTRICAL DISTRIBUTION RM.	12
239	MECHANICAL/HVAC RM.	TBD

LEGEND	
	ROAD
	ELEVATED ROAD
	PUBLIC AREA
	SERVICE ROOMS
	VERTICAL CIRCULATION
	RETAIL
	LANDSCAPE AREA
	NORMAL OPERATION EXIT WAY

DRAWING No. SHEET No. FILE BLDG. REF. No.

REVISIONS	REVISIONS

CONCEPTUAL DESIGN
NOT FOR CONSTRUCTION

Hatch Mott MacDonald

MRC McCORMICK RANKIN CORPORATION
A member of MMM GROUP

DRAWN _____
CHECKED _____
CORRECT _____

SCALE: 0 5 10 15 20m

YONGE SUBWAY EXTENSION

LANGSTAFF STATION
CONCOURSE LEVEL

Plot Date: 8/26/2011

TORONTO TRANSIT COMMISSION
ENGINEERING DEPARTMENT

Dwg. No. **SK-A-008E** Sheet No. _____

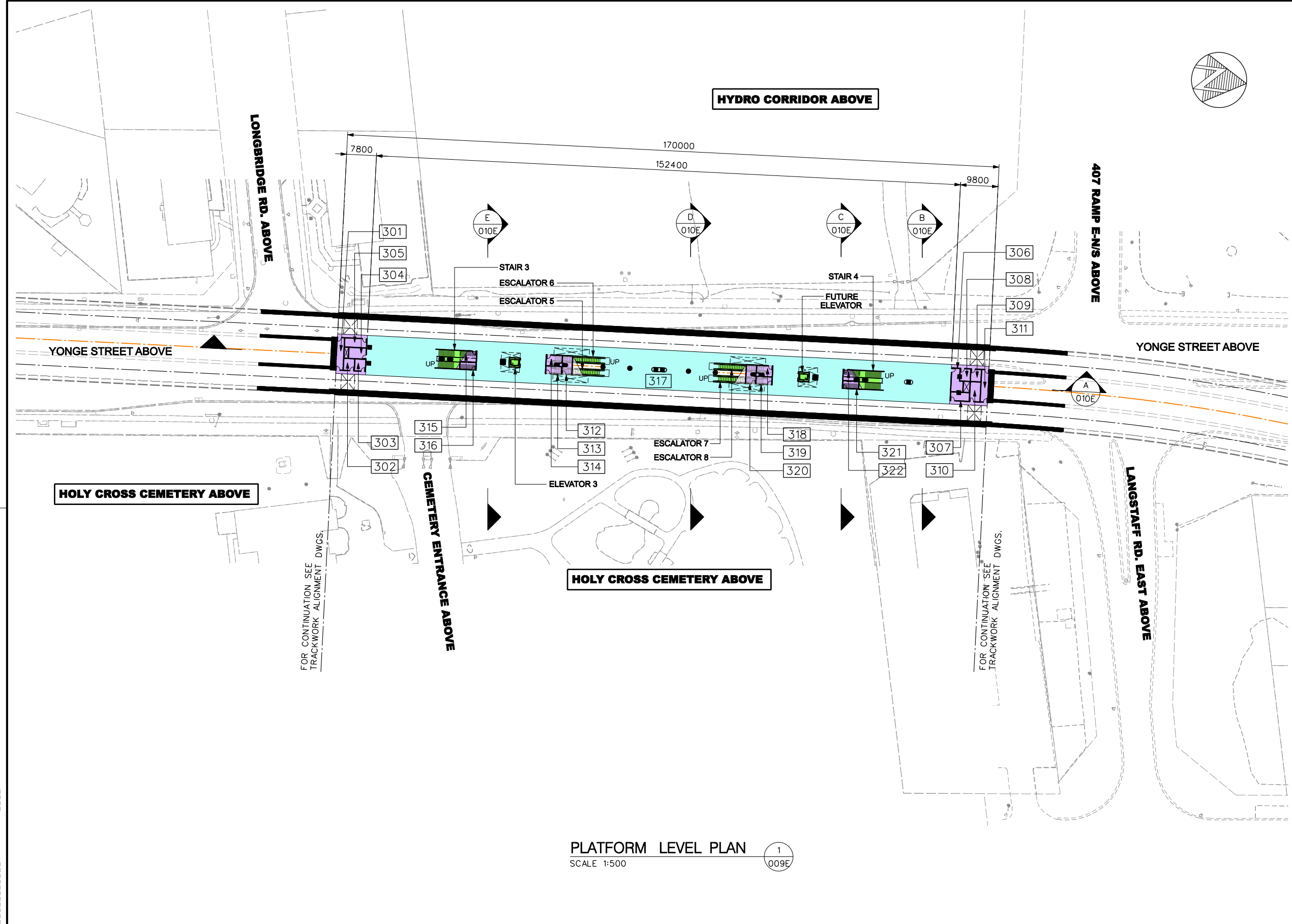

ROOM SCHEDULE LEGEND		
RM. No.	ROOM NAME	APPROX. RM. AREA
301	FIRE FIGHTERS ACCESS	12
302	POWER CABLE PULL RM	8
303	SYS. & COMM. CABLE PULL RM	8
304	D.C. TIEBREAKER ROOM	12
305	AUXILLARY ELECTRICAL RM.	12
306	AUXILLARY ELECTRICAL RM.	12
307	SUMP PUMP ROOM	10
308	SYS. & COMM. CABLE PULL RM	8
309	POWER CABLE PULL RM	8
310	P.E.D. ROOM (E.R.R.)	12
311	FIRE FIGHTERS ACCESS	15
312	SUMP PUMP ROOM	10
313	ESCALATOR STORAGE ROOM	7.5
314	ESCALATOR SERVICE ROOM	9
315	ELEVATOR MACHINE ROOM	7.3
316	ELEVATOR HVAC ROOM	11
317	SUBWAY PLATFORM	-
318	ESCALATOR SERVICE ROOM	9
319	ESCALATOR STORAGE ROOM	7.5
320	JANITOR SERVICE ROOM	10
321	FUTURE ELEVATOR MACHINE RM.	7.3
322	FUTURE ELEVATOR HVAC RM.	11

LEGEND	
	ROAD
	ELEVATED ROAD
	PUBLIC AREA
	SERVICE ROOMS
	VERTICAL CIRCULATION
	RETAIL
	LANDSCAPE AREA
	NORMAL OPERATION EXIT WAY

PLATFORM LEVEL PLAN 1/009E
SCALE 1:500

DRAWING No. SHEET No. FILE BLDG. REF. No.

REVISIONS	REVISIONS

CONCEPTUAL DESIGN
 NOT FOR CONSTRUCTION

DRAWN _____
 CHECKED _____
 CORRECT _____
 SCALE 0 5 10 15 20m

YONGE SUBWAY EXTENSION
LANGSTAFF STATION
 PLATFORM LEVEL

Plot Date: 8/26/2011

 TORONTO TRANSIT COMMISSION
 ENGINEERING DEPARTMENT
 Dwg. No. SK-A-009E Sheet No.

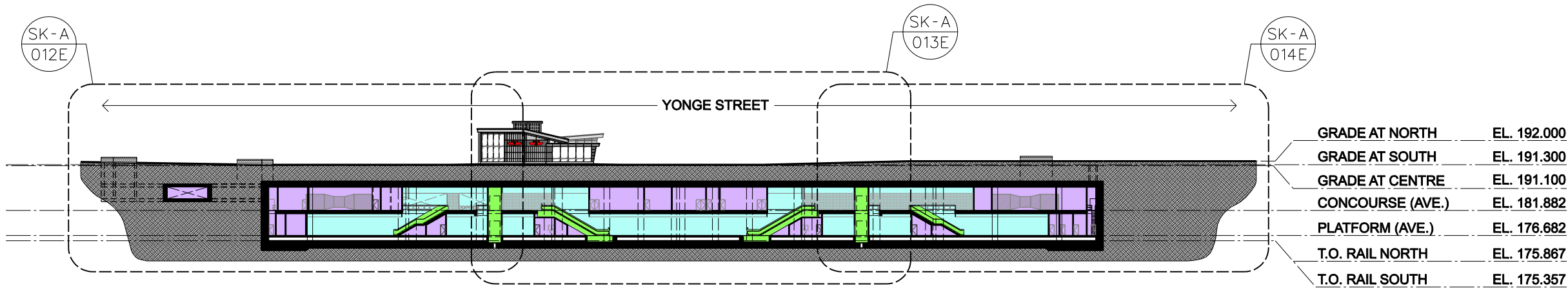

SECTION A-A
SCALE 1:500 LOOKING WEST
A SK-A-010E

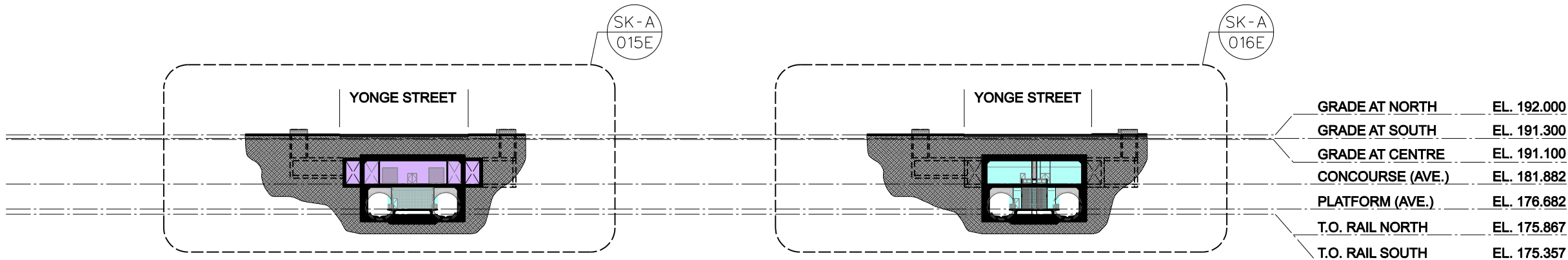

SECTION B-B
SCALE 1:500 LOOKING NORTH
B SK-A-010E

SECTION C-C
SCALE 1:500 LOOKING NORTH
C SK-A-010E

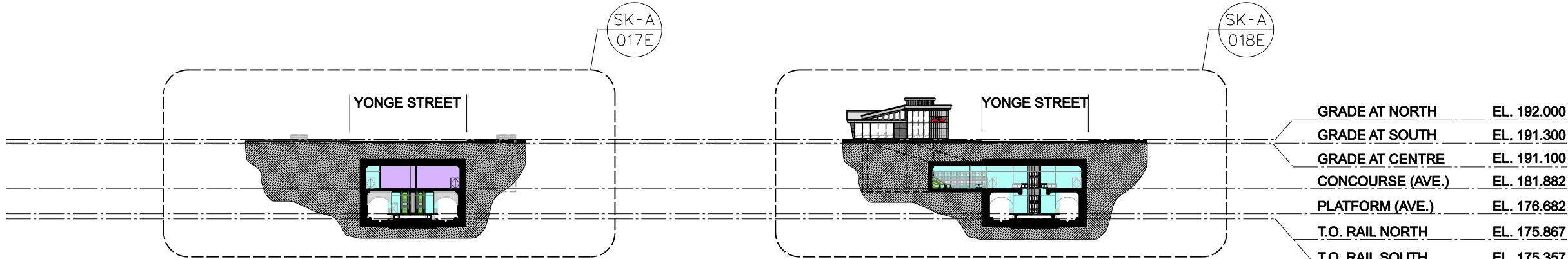

SECTION D-D
SCALE 1:500 LOOKING NORTH
D SK-A-010E

SECTION E-E
SCALE 1:500 LOOKING NORTH
E SK-A-010E

LEGEND

- ROAD
- ELEVATED ROAD
- PUBLIC AREA
- SERVICE ROOMS
- VERTICAL CIRCULATION
- RETAIL
- LANDSCAPE AREA
- NORMAL OPERATION EXIT WAY

BLDG. REF. No.

FILE

SHEET No.

DRAWING No.

REVISIONS	REVISIONS

CONCEPTUAL DESIGN
 NOT FOR CONSTRUCTION

DRAWN _____
 CHECKED _____
 CORRECT _____
 SCALE:

YONGE SUBWAY EXTENSION
LANGSTAFF STATION
 OVERALL CROSS SECTIONS

Plot Date: 8/26/2011

 TORONTO TRANSIT COMMISSION
 ENGINEERING DEPARTMENT
 Dwg. No. **SK-A-010E** Sheet No. _____

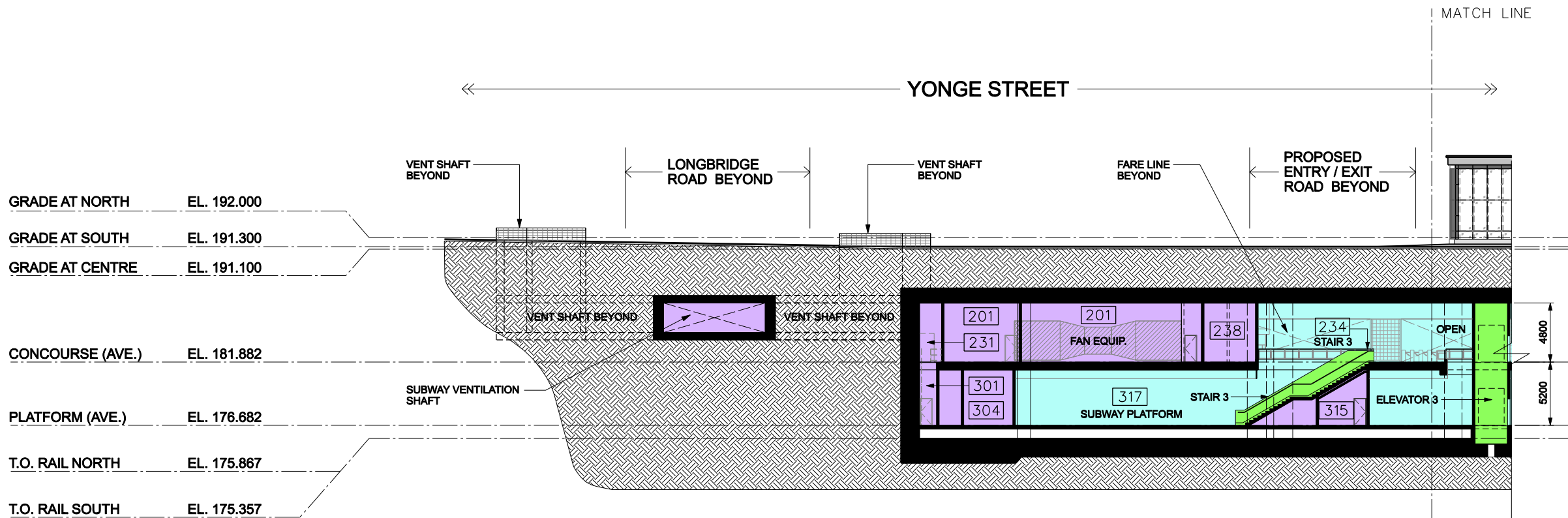

NOTE:
REFER TO PLANS FOR
ROOM SCHEDULE LEGEND

SK-A-012E | SK-A-013E

SECTION A-A - SOUTH END
SCALE 1:200 LOOKING WEST

- LEGEND
- ROAD
 - ELEVATED ROAD
 - PUBLIC AREA
 - SERVICE ROOMS
 - VERTICAL CIRCULATION
 - RETAIL
 - LANDSCAPE AREA
 - NORMAL OPERATION EXIT WAY

BLDG. REF. No. FILE SHEET No. DRAWING No.

REVISIONS	REVISIONS

CONCEPTUAL DESIGN
 NOT FOR CONSTRUCTION

DRAWN _____
 CHECKED _____
 CORRECT _____
 SCALE 0 1 2 3 4 5 8m

YONGE SUBWAY EXTENSION
LANGSTAFF STATION
 PART CROSS SECTIONS

Plot Date: 8/26/2011

 TORONTO TRANSIT COMMISSION
 ENGINEERING DEPARTMENT
 Dwg. No. SK-A-012E Sheet No.

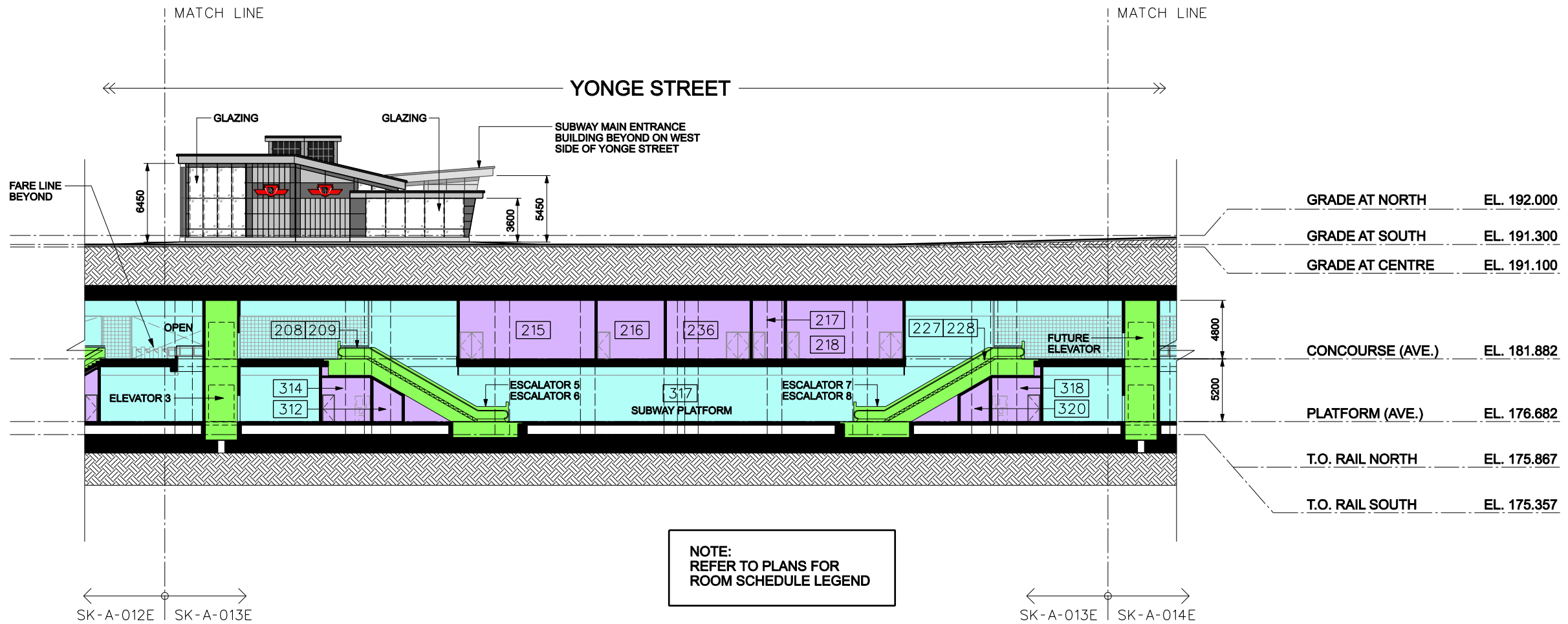

NOTE:
REFER TO PLANS FOR
ROOM SCHEDULE LEGEND

SECTION A-A - CENTRE
SCALE 1:200
LOOKING WEST
A
SK-A-013E

- LEGEND
- ROAD
 - ELEVATED ROAD
 - PUBLIC AREA
 - SERVICE ROOMS
 - VERTICAL CIRCULATION
 - RETAIL
 - LANDSCAPE AREA
 - NORMAL OPERATION EXIT WAY

BLDG. REF. NO.
FILE
SHEET No.
DRAWING No.

REVISIONS	REVISIONS

CONCEPTUAL DESIGN
 NOT FOR CONSTRUCTION

DRAWN _____
 CHECKED _____
 CORRECT _____
 SCALE

YONGE SUBWAY EXTENSION
LANGSTAFF STATION
 PART CROSS SECTIONS

Plot Date: 8/26/2011

TORONTO TRANSIT COMMISSION
 ENGINEERING DEPARTMENT
 Dwg. No. **SK-A-013E** Sheet No.

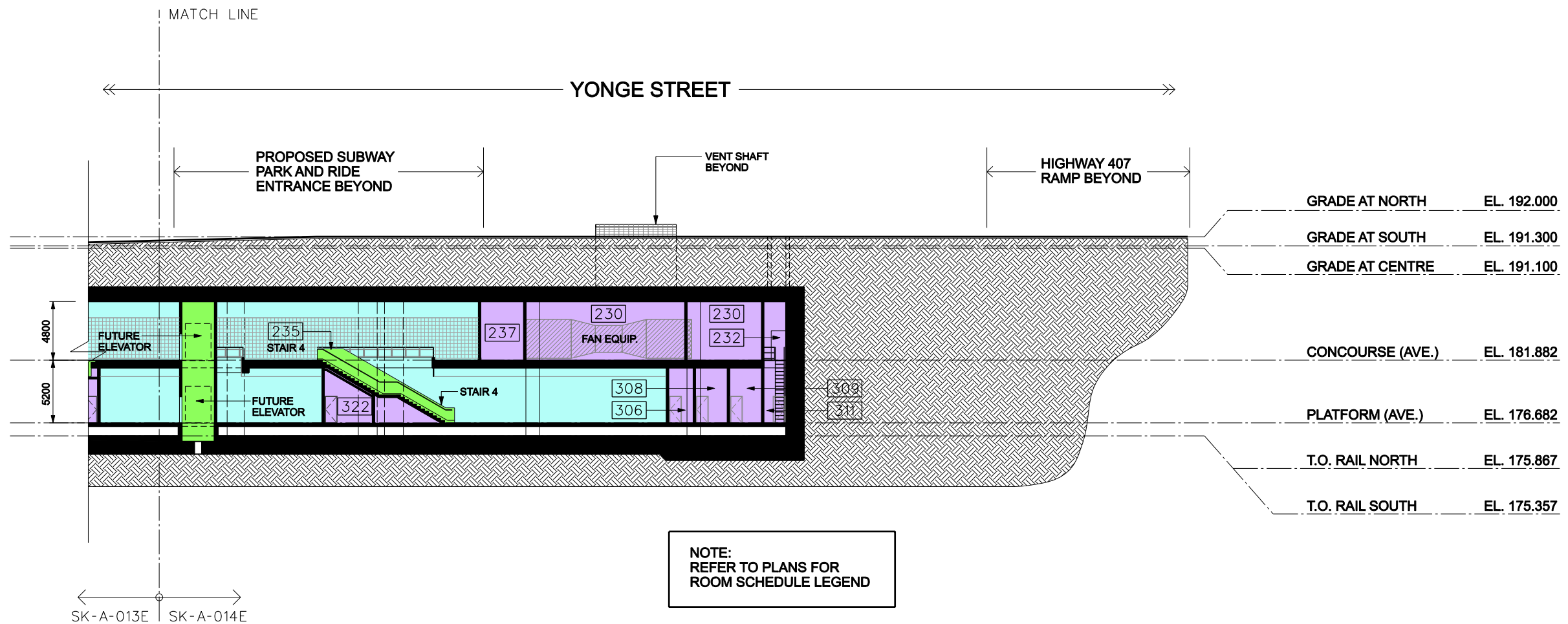

NOTE:
REFER TO PLANS FOR
ROOM SCHEDULE LEGEND

SECTION A-A - NORTH END
SCALE 1:200 LOOKING WEST

- LEGEND
- ROAD
 - ELEVATED ROAD
 - PUBLIC AREA
 - SERVICE ROOMS
 - VERTICAL CIRCULATION
 - RETAIL
 - LANDSCAPE AREA
 - NORMAL OPERATION EXIT WAY

BLDG. REF. No. FILE SHEET No. DRAWING No.

REVISIONS	REVISIONS

CONCEPTUAL DESIGN
 NOT FOR CONSTRUCTION

DRAWN _____
 CHECKED _____
 CORRECT _____
 SCALE: 5m

YONGE SUBWAY EXTENSION
LANGSTAFF STATION
 PART CROSS SECTIONS

Plot Date: 8/26/2011

 TORONTO TRANSIT COMMISSION
 ENGINEERING DEPARTMENT
 Dwg. No. **SK-A-014E** Sheet No. _____

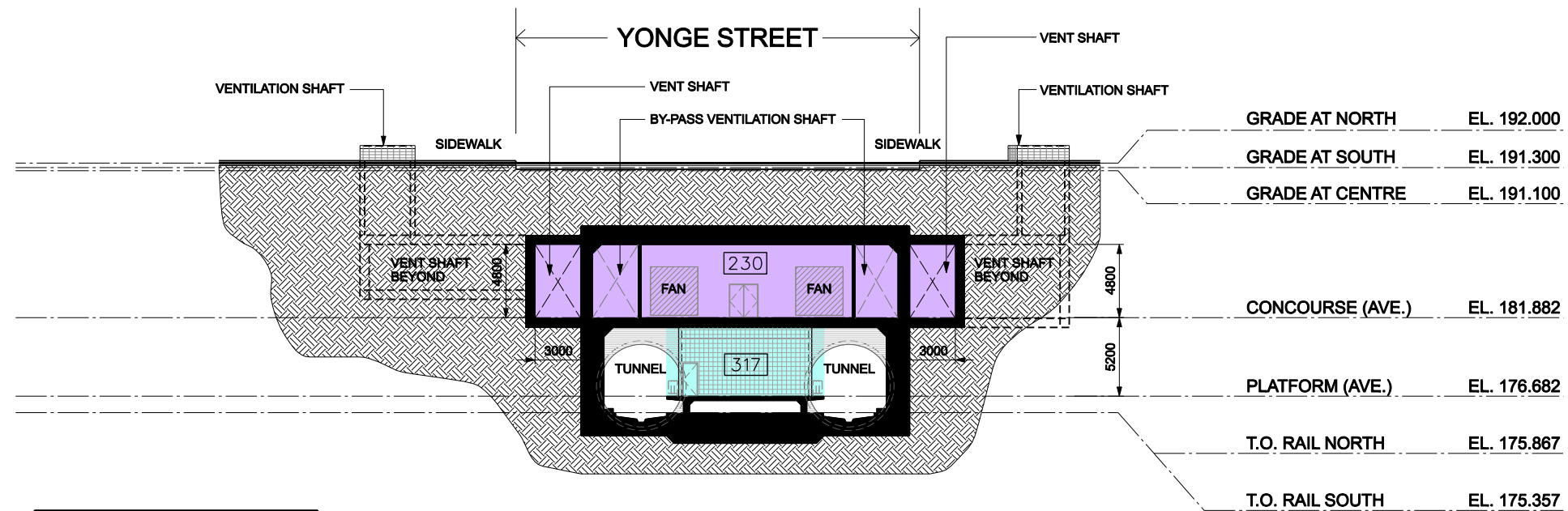

NOTE:
REFER TO PLANS FOR
ROOM SCHEDULE LEGEND

SECTION B-B
SCALE 1:200 LOOKING NORTH A
SK-A-015E

- LEGEND
- ROAD
 - ELEVATED ROAD
 - PUBLIC AREA
 - SERVICE ROOMS
 - VERTICAL CIRCULATION
 - RETAIL
 - LANDSCAPE AREA
 - NORMAL OPERATION EXIT WAY

BLDG. REF. No.
FILE
SHEET No.
DRAWING No.

REVISIONS	REVISIONS

CONCEPTUAL DESIGN
 NOT FOR CONSTRUCTION

DRAWN _____
 CHECKED _____
 CORRECT _____
 SCALE: 5m

YONGE SUBWAY EXTENSION
LANGSTAFF STATION
 PART CROSS SECTIONS

Plot Date: 8/26/2011

 TORONTO TRANSIT COMMISSION
 ENGINEERING DEPARTMENT
 Dwg. No. **SK-A-015E** Sheet No. _____

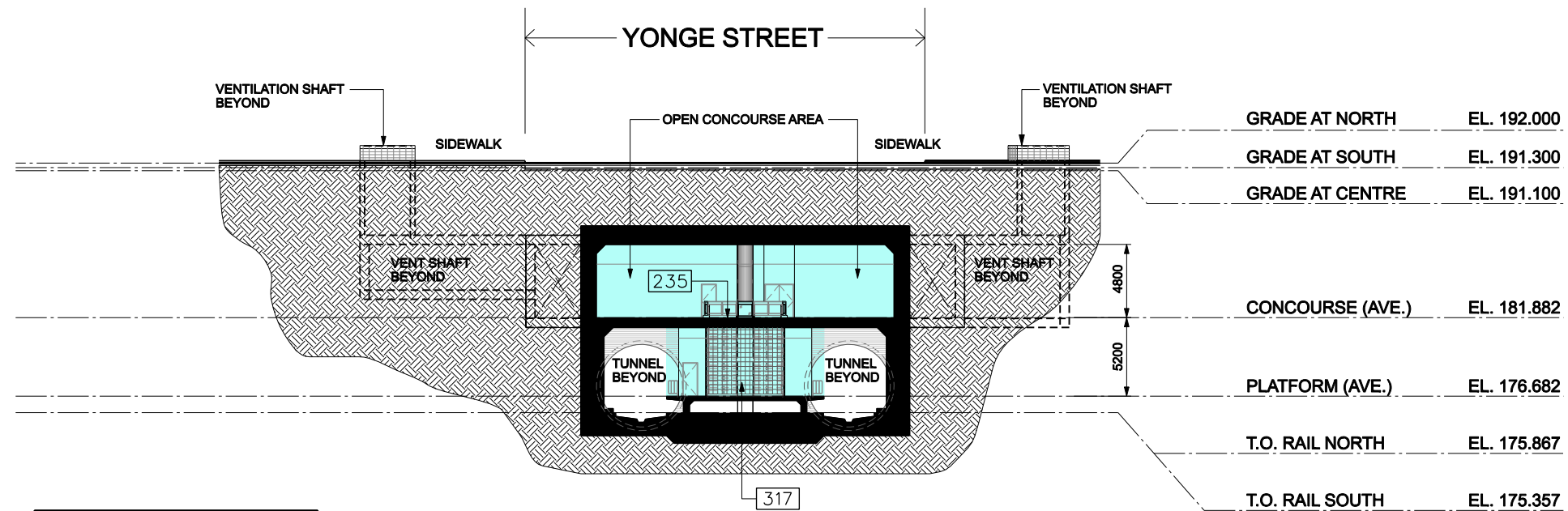

NOTE:
REFER TO PLANS FOR
ROOM SCHEDULE LEGEND

SECTION C-C
SCALE 1:200 LOOKING NORTH A SK-A-016E

- LEGEND**
- ROAD
 - ELEVATED ROAD
 - PUBLIC AREA
 - SERVICE ROOMS
 - VERTICAL CIRCULATION
 - RETAIL
 - LANDSCAPE AREA
 - NORMAL OPERATION EXIT WAY

BLDG. REF. No.
FILE
SHEET No.
DRAWING No.

REVISIONS	REVISIONS
△	△
△	△
△	△

CONCEPTUAL DESIGN
NOT FOR CONSTRUCTION

DRAWN _____
CHECKED _____
CORRECT _____

SCALE
0 1 2 3 4 5 8m

YONGE SUBWAY EXTENSION
LANGSTAFF STATION
PART CROSS SECTIONS

Plot Date: 8/26/2011

TORONTO TRANSIT COMMISSION
ENGINEERING DEPARTMENT

Dwg. No. **SK-A-016E** Sheet No. _____

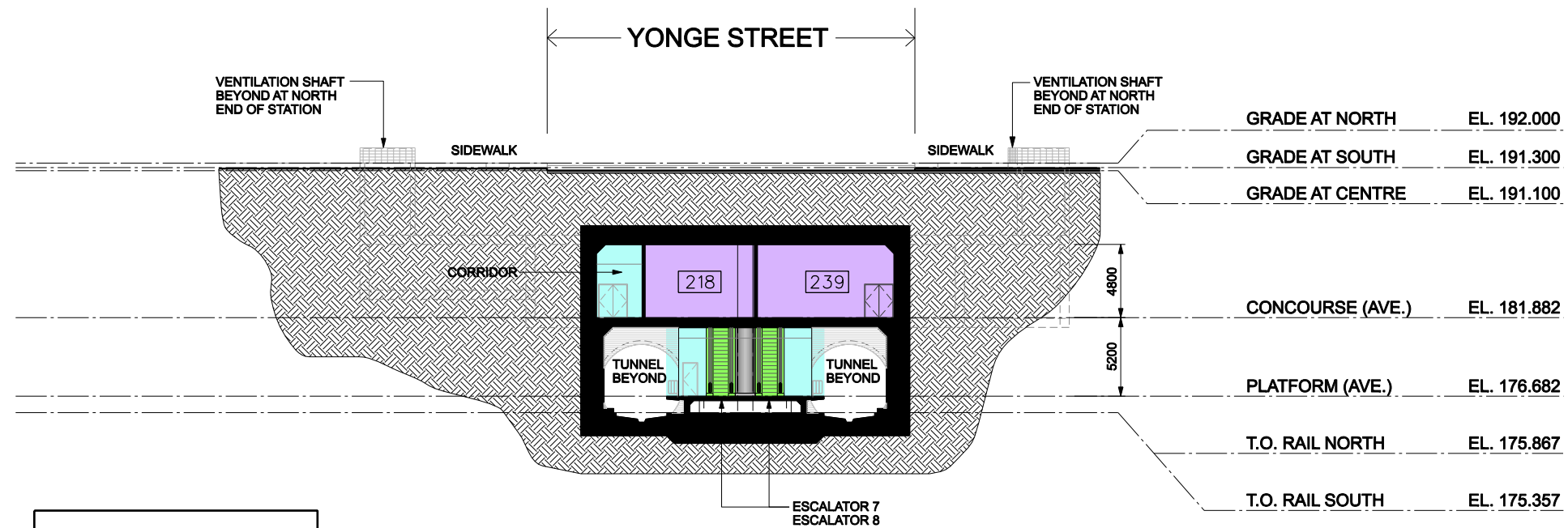

NOTE:
REFER TO PLANS FOR
ROOM SCHEDULE LEGEND

SECTION D-D
SCALE 1:200
LOOKING NORTH
A SK-A-017E

LEGEND

[Grey Box]	ROAD
[Light Grey Box]	ELEVATED ROAD
[Light Blue Box]	PUBLIC AREA
[Purple Box]	SERVICE ROOMS
[Green Box]	VERTICAL CIRCULATION
[Yellow Box]	RETAIL
[Dark Green Box]	LANDSCAPE AREA
[Dashed Line]	NORMAL OPERATION EXIT WAY

BLDG. REF. No.
FILE
SHEET No.
DRAWING No.

REVISIONS	REVISIONS
△	△
△	△
△	△

CONCEPTUAL DESIGN
 NOT FOR CONSTRUCTION

Hatch Mott MacDonald
MRC McCormick Rankin Corporation
 A member of MMM GROUP

DRAWN _____
 CHECKED _____
 CORRECT _____

SCALE
 0 1 2 3 4 5 8m

YONGE SUBWAY EXTENSION
LANGSTAFF STATION
 PART CROSS SECTIONS

Plot Date: 8/26/2011

TORONTO TRANSIT COMMISSION
 ENGINEERING DEPARTMENT

Dwg. No. **SK-A-017E** Sheet No. _____

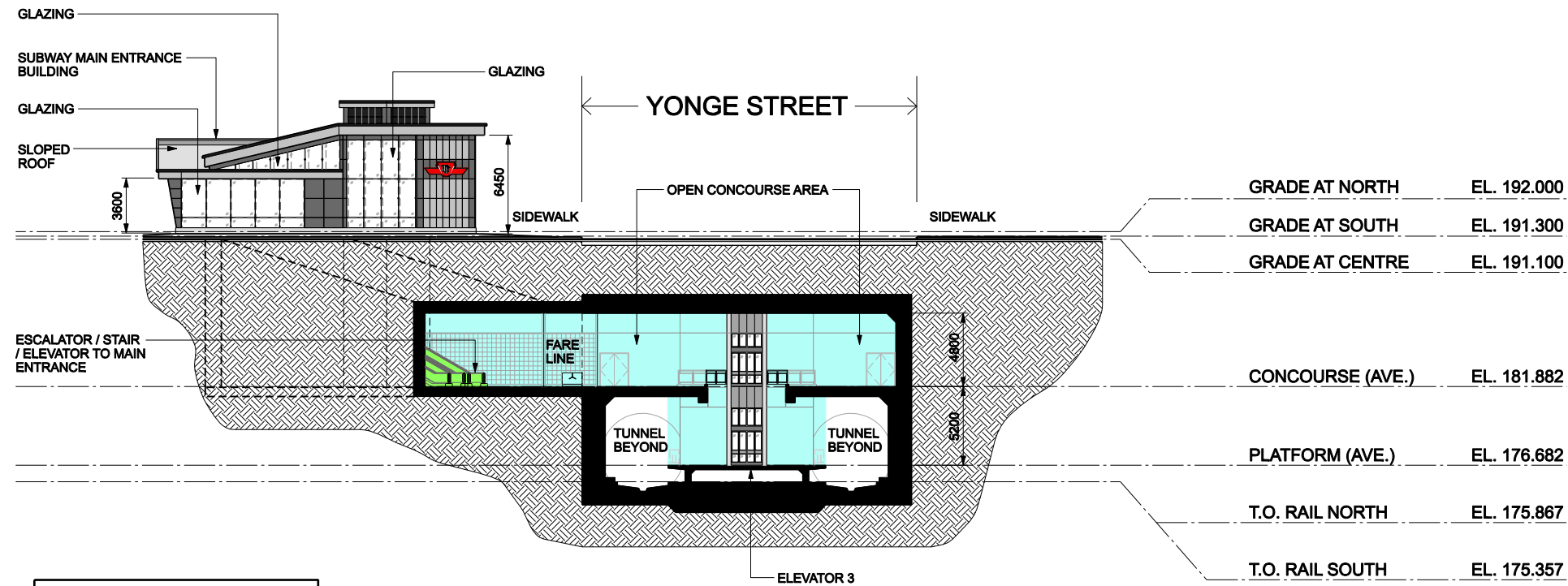

NOTE:
REFER TO PLANS FOR
ROOM SCHEDULE LEGEND

SECTION E-E
SCALE 1:200 LOOKING NORTH A SK-A-018E

- LEGEND**
- ROAD
 - ELEVATED ROAD
 - PUBLIC AREA
 - SERVICE ROOMS
 - VERTICAL CIRCULATION
 - RETAIL
 - LANDSCAPE AREA
 - NORMAL OPERATION EXIT WAY

BLDG. REF. No. FILE SHEET No. DRAWING No.

REVISIONS	REVISIONS

CONCEPTUAL DESIGN
 NOT FOR CONSTRUCTION

DRAWN _____
 CHECKED _____
 CORRECT _____
 SCALE: 0 1 2 3 4 5 8m

YONGE SUBWAY EXTENSION
LANGSTAFF STATION
 PART CROSS SECTIONS

Plot Date: 8/26/2011

 TORONTO TRANSIT COMMISSION
 ENGINEERING DEPARTMENT
 Dwg. No. **SK-A-018E** Sheet No.

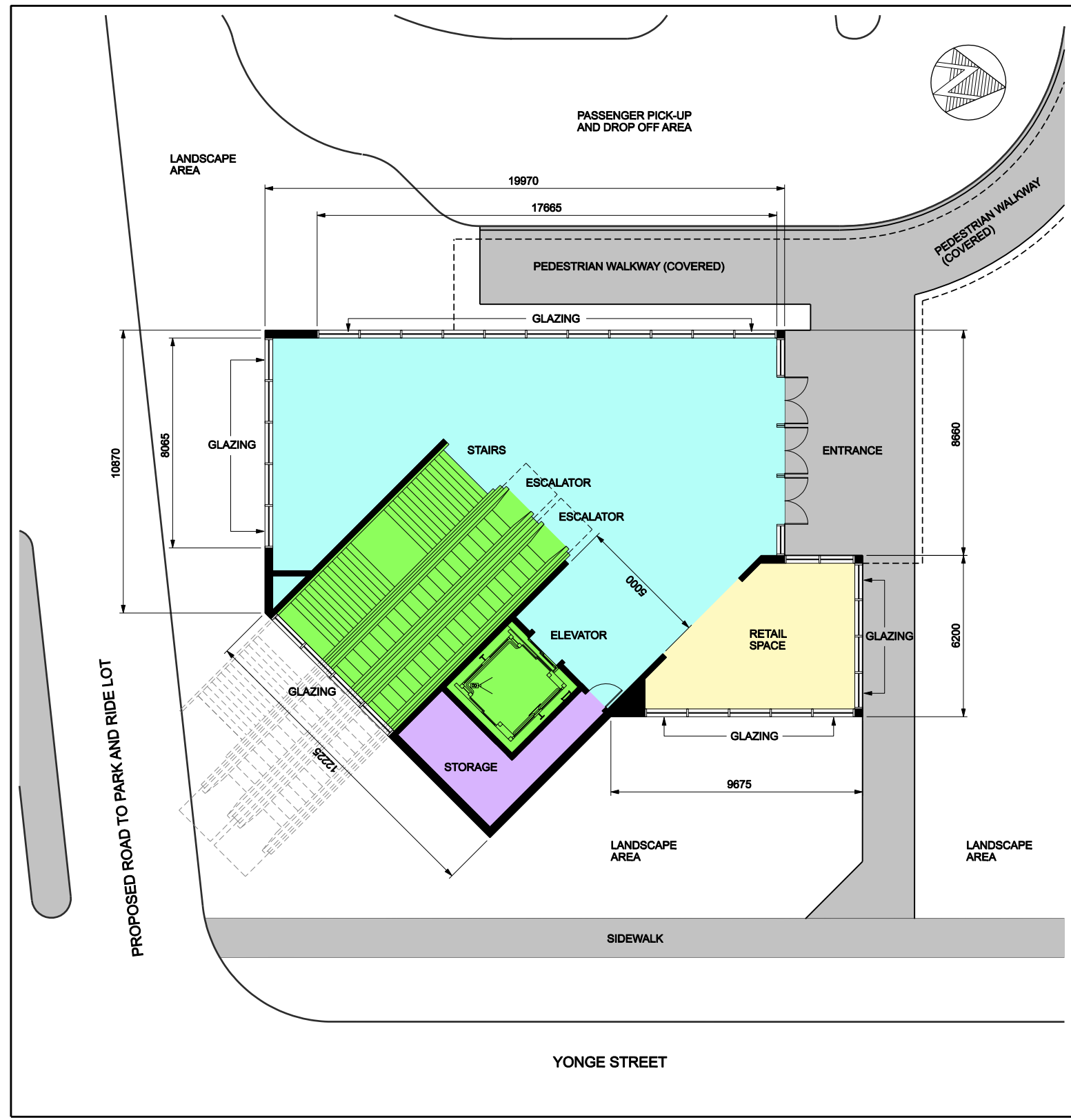

MAIN ENTRANCE PLAN
SCALE 1:100

1
019E

DRAWING No. SHEET No. FILE BLDG. REF. No.

REVISIONS	REVISIONS

CONCEPTUAL DESIGN
 NOT FOR CONSTRUCTION

 Hatch Mott MacDonald
 MRC McCormick Rankin Corporation
A member of MMM GROUP

DRAWN
 CHECKED
 CORRECT
 SCALE

YONGE SUBWAY EXTENSION
LANGSTAFF STATION
 STREET LEVEL - ENTRANCES

Plot Date: 8/26/2011

 TORONTO TRANSIT COMMISSION
 ENGINEERING DEPARTMENT
 Dwg. No. SK-A-019E
 Sheet No.

11. RICHMOND HILL CENTRE STATION

Richmond Hill Centre Station is located off the Yonge Street alignment in the Richmond Hill Centre with the station box positioned approximately 250m east of Yonge Street and directly below the existing High Tech road overpass and current Silver City theatre complex. A crossover will be located south of the station with tail tracks and a train storage facility located north of the station. A 25-bay bus terminal, for YRT, Viva and GO Transit services, has been identified; however, five of those bus bays, allotted for GO Transit, could potentially be diverted to the proposed 407 Transitway Station. An existing GO Transit rail station is located east of the CN Bala Subdivision rail line and is connected to the existing Viva/407 bus terminal on the west side by an overhead pedestrian bridge.

At the time the YSE TPAP was completed, the preferred layout of the subway station and the associated surface facilities (bus terminal, PPUDO, station entrances, etc.) was developed based on the current road network surrounding the station site. Since then, the Town of Richmond Hill has completed a new land use plan for the Richmond Hill Centre area that is built upon a network of elevated roads within the station area. The station area – currently bounded by High Tech Road to the north, Garden Avenue to the south, and Yonge Street to the west – will be transformed by a network of roads that begins at ground level at Yonge Street and then rises up to approximately one to two levels above ground with the high point located over the CN Bala Subdivision. Garden Avenue would be realigned and extended to the east over the CN rail corridor. The proposed Station Street would provide a direct north-south connection between Highway 7 and High Tech Road.

Balancing the transit commuter needs along with transit oriented development aspirations, a number of bus terminal options were developed to various levels of detail as part of this work. A single level option was used for the purpose of costing estimation. However, the terminal design will continue to evolve during the next phases of design.

For the single level bus facility, the following assumptions were included within the costing exercise:

- There are two connections from the bus terminal to the station concourse.
- The main entrance is located at the south end of the station box on the west side and a secondary entrance located on the west side of the station box and positioned on the north side of the High Tech Bridge overpass.
- A single level substation is also located on the north side of the High Tech Bridge overpass but on the east side of the station box.
- A future entrance is located at the south end of the station box on the east side.

Richmond Hill Centre Station is the proposed terminus of the YSE. The planned station box would be located east of Yonge Street traversing High Tech Road, west of the CN Bala Subdivision, and north of Highway 7. The location of the terminus station provides a high potential for intensification and an integrated inter-modal transportation hub. The station box location is based on the TPAP preferred subway alignment (Alignment C) which acts as an anchor between the GO Richmond Hill line and the planned future Highway 407 Transitway.

Key station features are as follows:

- Crossover at the south end of the station
- A major inter-regional bus terminal for YRT/Viva and GO Bus services
- Entrances at the north and south ends of the station
- An electrical substation at the north end of the station
- A passenger pick-up/drop-off facility

The biggest challenge for a successful design solution at this station is the integration of multimodal transit elements to minimise transfer times between modes. In particular, the following elements must be integrated:

- GO Transit trains, via existing bridge to existing YRT bus platform;
- A new Viva/YRT bus terminal with 25 bays:
 - If the Highway 407 Transitway is built at the same time this can be reduced by 5 bays.
- The Highway 407 Transitway station with side platforms; and
- The TTC subway station, including:
 - Crossover south of the station;
 - Storage facility north of the station; and
 - Passenger Pick-up and Drop-off (PPUDO.)

The level of development and the timing of construction of the future Highway 407 Transitway are key challenges in the development of the station site. The transitway station and associated tunnel are currently shown crossing over the TTC subway tunnels. Unless the Transitway design allows for a crossover of the bus lanes, the transitway station is likely to be a side platform configuration, making connection to the subway difficult without an intermediary concourse level. It would be preferable to adjust the transitway station location to coincide with the TTC subway station and integrate into a single construction project. This will maximise the potential for proper integration between the facilities.

The importance of this location to the developing Richmond Hill Centre requires thorough integration with urban infrastructure and the surrounding developments. Underground transportation infrastructure effectively sterilizes the surface for development due to the difficulty of integrating structure, and the very large spans involved. The next phase of the design must focus on maximising the potential for TOD and urban design of this area without compromising the operational needs of the various transit facilities.

There remain three main design areas that need to be addressed in the next phase of design:

- Design of bus terminal – integrated into future Transit-Oriented Development – to connect with the planned Richmond Hill Centre road network, the subway, the existing GO Rail line, and the future Highway 407 Transitway
- Work with Stakeholders to revise the Transit-Oriented Development plan proposed by the Town of Richmond Hill to
 - Maximize the potential for future TOD;
 - Minimise the impact of future developments on the operations of the intermodal transit facility.
- Enable the transit facilities to be constructed independently from the Richmond Hill Centre development as the timings may not coincide with one another

11.1 Passenger Transfer Movements

The passenger transfer movements at Richmond Hill Centre Station were estimated based on the passenger demand forecast analysis described in Section 2 and Appendix 'A' of this report. A breakdown of the forecast 2031 AM peak hour transfer movements by mode and by direction can be found in **Table 11-1**.

Table 11-1: Estimated Passenger Transfer Movements at Richmond Hill Centre Station (2031)

AM Peak Hour TRANSFERS		OUT OF STATION								TOTAL
INTO STATION	DIR	SUBWAY	GO BUS			GO TRAIN			WALK OUT	
		SB	EB	WB	SB	EB	NB	WB		
SUBWAY	NB	0	60	0	0	160	240	40	290	790
GO BUS	EB	70	0	0	50	0	10	0	0	130
	WB	760	50	0	20	10	40	50	20	950
GO TRAIN	SB	460	0	0	0	0	10	0	10	480
YRT/VIVA	EB	680	110	20	200	10	40	10	0	1070
	SB	5090	30	100	300	160	0	70	30	5780
	WB	5660	10	70	220	0	70	80	20	6130
WALK IN		580	10	30	30	10	30	20	0	710
PARK 'N' RIDE		0	0	0	300	0	0	0	0	300
TOTAL		13300	270	220	1120	350	440	270	370	16340

As shown in Table 11-1, transfer movements at RHC Station are predominantly between the subway and connecting YRT/Viva and GO bus routes. Of the total 16,340 AM peak hour passenger movements projected at Richmond Hill Centre Station, about 78% (12,760) represents transfers between the subway and connecting bus routes, 6% are bus to bus transfers, and 5% (870) are transfers between the subway and walk-in/out. It is worth noting that transfers to and from the GO Train represents about 10% of the total transfer movements at Richmond Hill Centre Station. It is anticipated that future walk in passengers will increase as a result of the development proposed within the Richmond Hill Centre.

Passenger flow diagrams prepared for Richmond Hill Centre Station can be found in Appendix 'E' of this report.

11.2 Bus Terminal

The TPAP preferred concept includes a two-level bus terminal with 28 bus bays to accommodate the large number of YRT/Viva and GO bus routes that will be serving the station. The required number of bus bays has since been reduced to 25 through consultation with YRT staff. The current proposed bus bay allocation for YRT/Viva and GO routes are summarized in **Tables 11-2 and 11-3**.

Based on the 25-bay requirement, several design options for the bus terminal were explored by the design team – they are illustrated in **Figures 11-1 to 11-5**.

Table 11-2: Proposed YRT/Viva Bus Bay Allocation at Richmond Hill Centre Station

Route	Type	Future A.M. Peak Headway (minutes)	Bus Bays	Bus Type
YRT				
300 Business Express	Terminating	Express	2	12m
301 Markham Express	Terminating	Express		
302 Unionville Express	Terminating	Express		
303 Cornell Express	Terminating	Express		
360 Maple Express	Terminating	20' 00"		
New Langstaff Route	TBD	TBD		
91A/B/E Bayview South	Terminating	10	1	12m
1 Highway 7	Terminating	15	1	12m
99 Yonge South NB	Through	10	1	12m
99 Yonge South SB	Through	10	1	12m
85 Rutherford/Carville West	Terminating	10	1	12m
85 Rutherford/Carville East	Terminating	10	1	12m
83/83A Trench	Terminating	15	1	12m
87 Langstaff Maple	Terminating	15		12m
88A Bathurst to RHC	Terminating	10	1	12m
Mobility Plus	On Demand			
Sub-Total			10	
Viva				
Blue	Terminating	2	2	18m
Purple EB	Through	4	1	18m
Purple WB	Through	4	1	18m
Sub-Total			4	
MISC				
Unloading			3	
Growth			3	
Sub-Total			6	
TOTAL			20	

Table 11-3: Proposed GO Bus Bay Allocation at Richmond Hill Centre Station

Route	Type	Future A.M. Peak Headway (minutes)	Bus Bays
32 Brampton Trinity Common	Terminating	15	1
Hwy 404 Northern Route	Terminating	20	
40 Airport Express	Terminating	30	
52 Hwy 407 East (Oshawa) WB	Through	5	1
51 Hwy 407 East (Pickering) WB			
54 Hwy 406 East (Mount Joy) WB			
52 Hwy 407 East (Oshawa) EB	Through	5	1
51 Hwy 407 East (Pickering) EB			
54 Hwy 406 East (Mount Joy) EB			
Sub-Total			4
MISC			
Unloading (GO)			
Growth (GO)			1
Sub-Total			1
TOTAL			5

Figure 11-1: Richmond Hill Centre Station 2 Level Bus Terminal Option 1 (Lower Level)

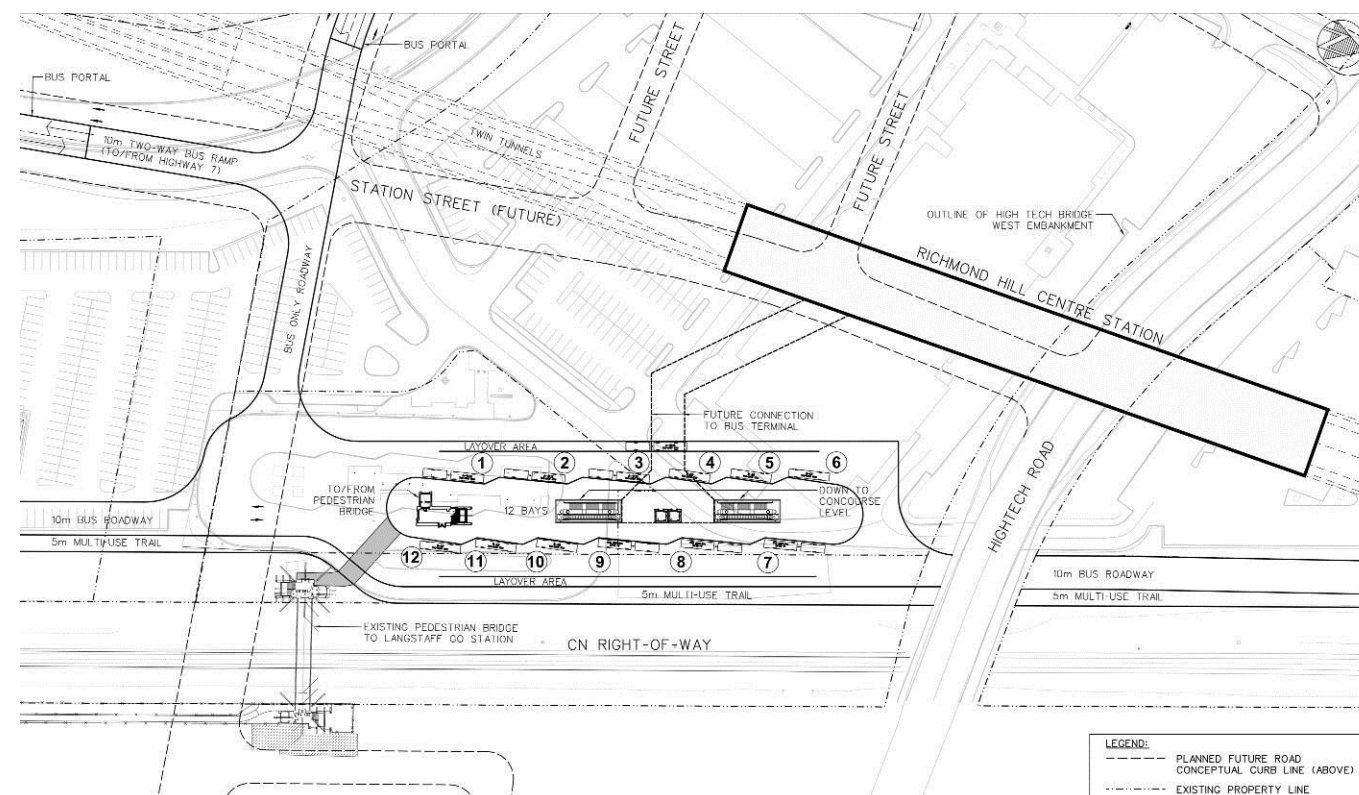

Figure 11-2: Richmond Hill Centre Station 2 Level Bus Terminal Option 1 (Upper Level)

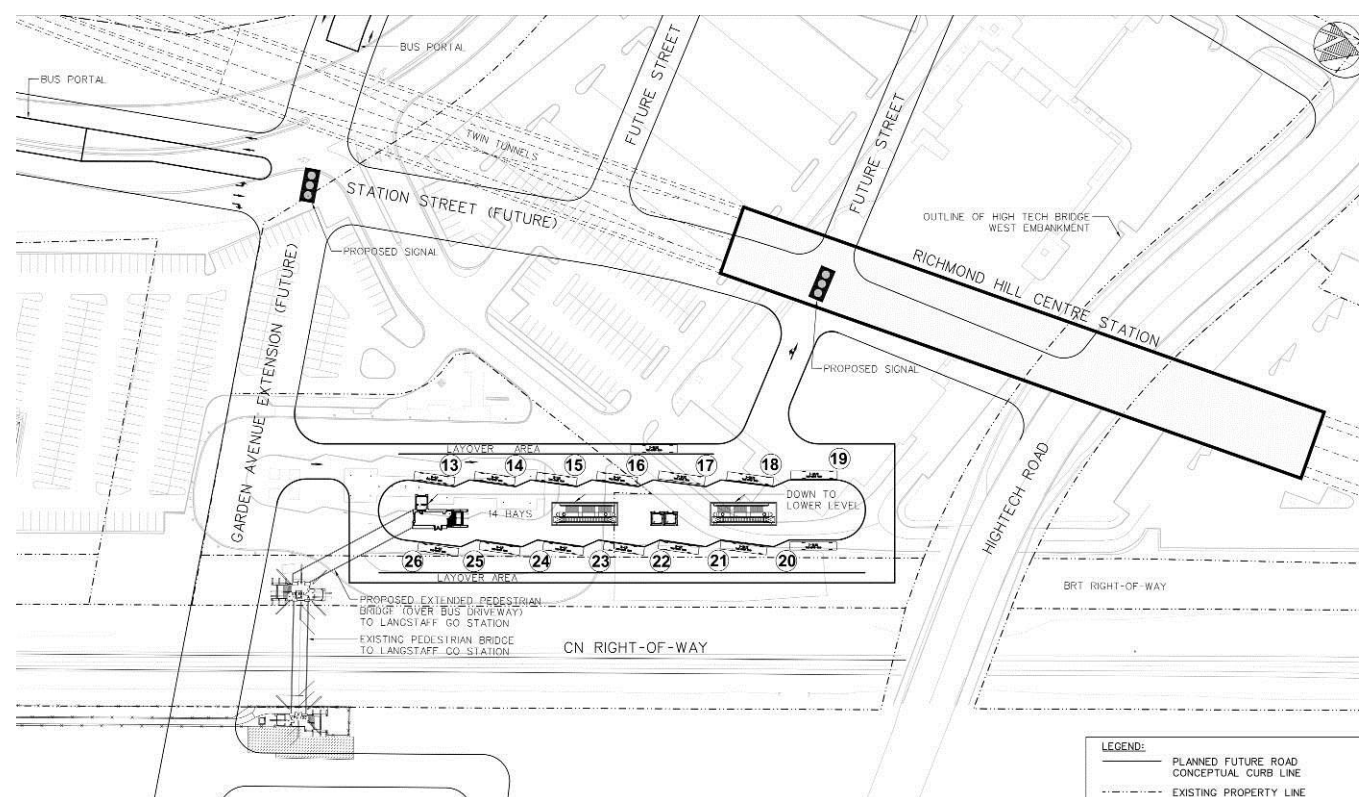

Figure 11-3: Richmond Hill Centre Station Bus Terminal Option 2 (Single Level)

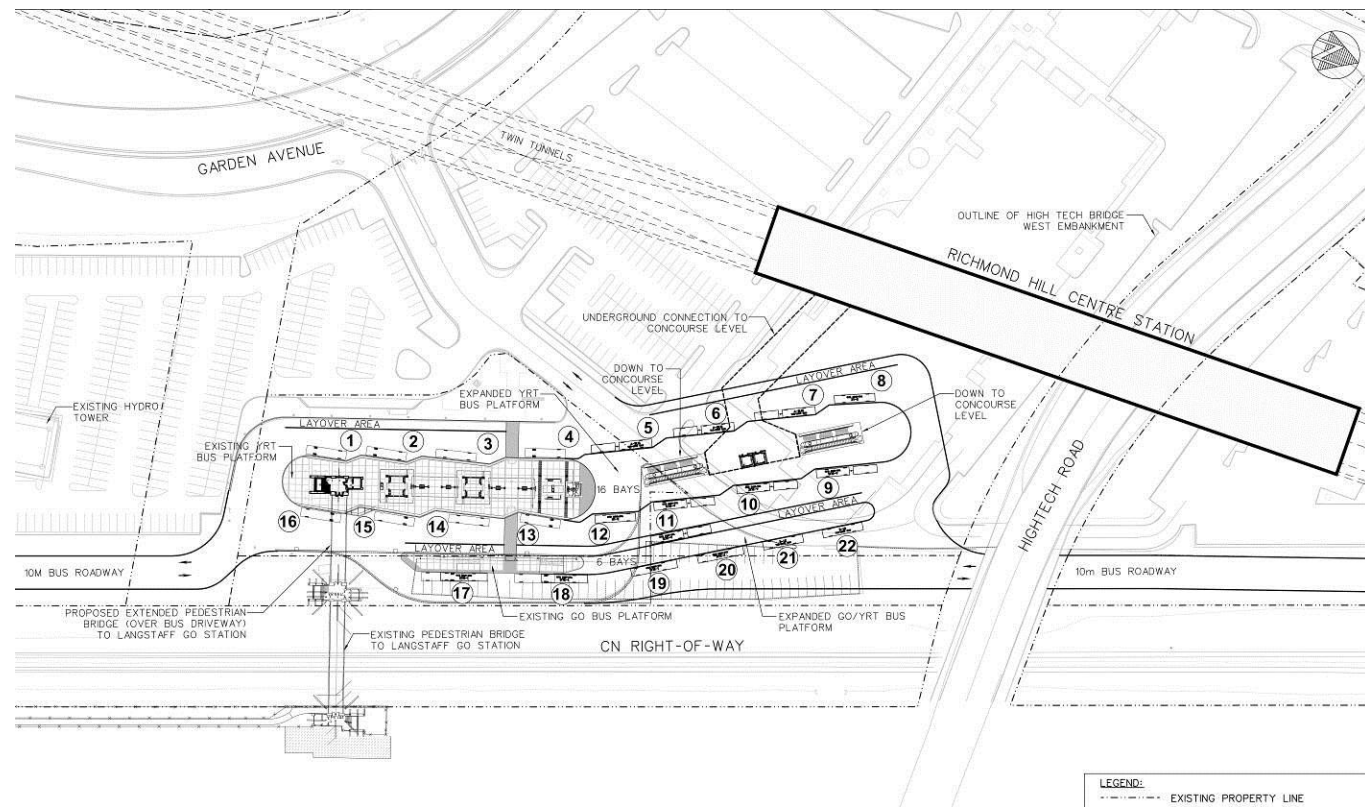
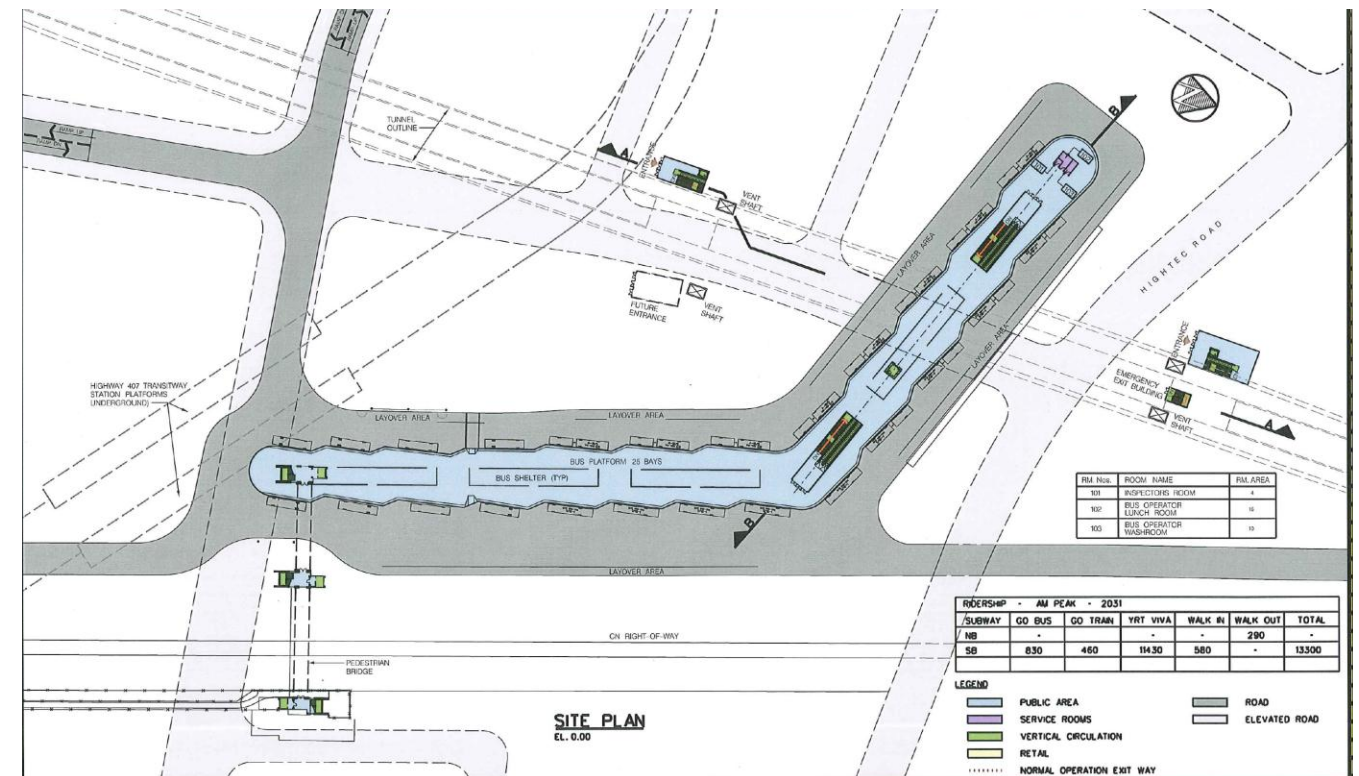
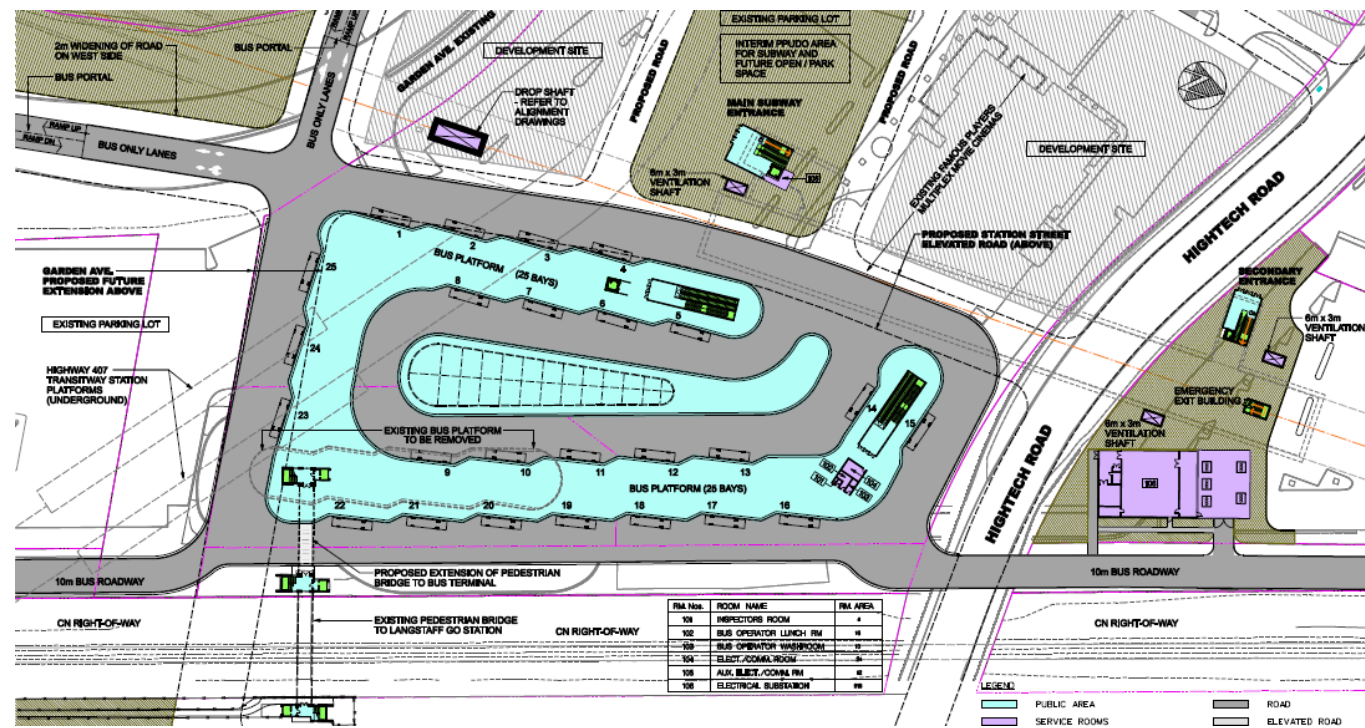

Figure 11-5: Richmond Hill Centre Station Bus Terminal Option 4 (Single Level)



- Option 4 was used for costing purposes.

Figure 11-4: Richmond Hill Centre Station Bus Terminal Option 3 (Single Level)



One option that has been carried forward for costing purposes (Option 4) is a single level terminal that connects the subway station to Langstaff GO Station via the existing pedestrian bridge. The design features a single island platform in a “boomerang” shape that incorporates the existing YRT Richmond Hill Centre Terminal and the pedestrian bridge to Langstaff GO Station. The intent of this option is to reduce the impact on development by placing the bus terminal between development and lands that have a negative impact on development such as the rail line and the road embankment. The bus platform extends northerly from the existing YRT terminal then continues westerly along the south embankment of High Tech Road. A number of glazed shelters provide protection for YRT and GO bus passengers, with two of these containing up and down escalators and a stairwell to the subway concourse level for a total of four escalators and two stairways. A separate shelter provides an elevator for access to the concourse. The design also protects for a future passenger connection to the Highway 407 Transitway. Buses will enter and exit the bus terminal via a bus roadway running parallel to the CN right-of-way at the east end of the terminal, as well as a bus-only driveway connecting to Garden Avenue.

The bus terminal, including the subway station, must be designed to be fully integrated into future development and the future road network planned by the Town of Richmond Hill, but can be constructed independently in case the implementation of YSE and area development do not coincide. As this area develops the grade level will be lifted, so much of the bus terminal will, when the area is fully developed, be one storey below grade. When the bus terminal is below grade, additional ventilation may be required to remove fumes from bus operations.

While option 4 has been carried forward for pricing purposes, the single level option does compromise development opportunities along High Tech Road. Given the complexity and importance of the relationship between TOD and transit facilities within the area, it is recognized that more design and planning work is required for the bus terminal and associated surface facilities around the following key principles:

- Provide a high quality, efficient passenger connection between the various modes of transit included within the anchor hub
- Provide good access to facilitate surface transit operations
- Maximize the use of lands that are already encumbered for development for transit purposes
- Facilitate opportunities for integration with future TOD
- Allow for construction and operation independent of the status of surrounding development

This further work will be developed through the next stage of design in consultation with all key stakeholders including the Town of Richmond Hill, the Town of Markham, the 407 ETR, Metrolinx, and area land owners.

11.3 Station Entrances

The Main Entrance is located in the future Open/Park Space on the west side of the proposed Station Street which is an elevated road situated one level above ground. A Secondary Entrance is located on the north side of High Tech Road, west of the alignment. A future secondary entrance has been located opposite the Main Entrance on the east side of Station Street, and can be built as a development connection. The future Secondary Entrance will require the developer to provide TTC specification stairs, elevator, escalators, and signage that must remain accessible through the same hours as the TTC station.

The Main Entrance is fully accessible with an elevator, two escalators, and stairs. The Secondary Entrance has been designed with an escalator, stairs, and an elevator.

11.4 Street Level

A Station Emergency Exit Building is located directly above the alignment north of High Tech Road next to the Secondary Entrance. A traction power substation is located to the west side of the proposed Bus Roadway at ground level north of High Tech Road.

Emergency ventilation shafts are located at the south end of the station on both sides of the proposed Station Street. At the north end of the station, both vent shafts are located on the north side of High Tech Road adjacent to the Secondary Entrance. Note that additional station ventilation shafts are required for normal exhaust and makeup air to staffed spaces below grade, and will be sized and located in the next phase of design. Fire Fighter's Access shafts will also be located in the next phase of design following further design development.

11.5 Concourse Level

In order to make connections between the various modes at this complex station, the concourse level has been extended. Entering the concourse from the Main Entrance, passengers enter the south end of the station box and pass an automatic fareline to move towards the collector's booth at the centre of the concourse. Entering the concourse from the Secondary Entrance, passengers enter the north end of the station box and pass an automatic fareline identical to that at the south end of the concourse to move towards the collector's booth at the centre of the concourse.

Passengers coming down the eastern set of stair, escalators, and the elevator from the bus terminal enter the concourse close to the collector's booth. All three entrances, along with the future secondary entrance, are connected to the unpaid side of the fareline which makes TOD connections more cost effective (i.e. no need to install automatic fare equipment). Passengers coming down the western set of stairs and escalators from the bus terminal come to an automatic fareline to enter the fare paid part of the concourse. Moving through the fare lines into the paid concourse, passengers have three stair/escalator combinations and an elevator to take them down to the platform level.

The concourse also contains service rooms and two sets of emergency ventilation fans at both ends of the station box.

11.6 Platform Level

Patrons move between concourse and platform using three escalators, three sets of stairs, and an elevator. As the stairs and escalators do not provide sufficient vertical circulation under emergency conditions, an SEEB is provided at the north end of the platform. This will require dynamic signage similar to that installed on the Sheppard Subway (“EXIT when flashing”), triggered by activation of the emergency ventilation system.

11.7 Roads

For all options, the Town of Richmond Hill's proposed road network was used. Assumptions were made for the two level bus terminals regarding the proposed elevation of Garden Avenue over the CN corridor. Modifications to the road network may be considered during the next design phases as the bus terminal and development issues are resolved.

11.8 Passenger Pick-Up/Drop-Off







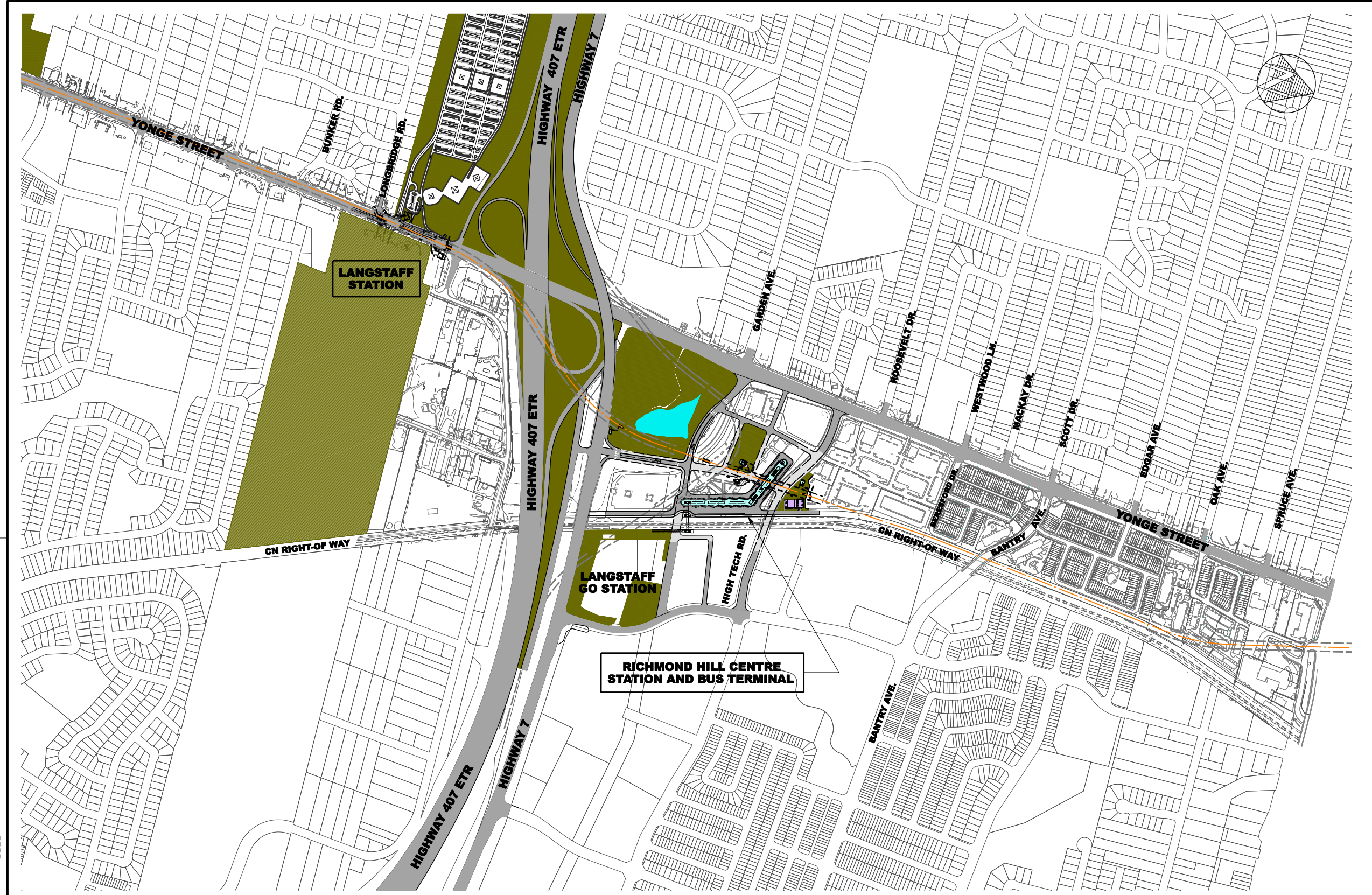

A stand-alone passenger pick-up/drop-off (PPUDO) facility was previously identified during the YSE TPAP and it was to be situated on the west side of the two-level bus terminal. In light of the proposed development plan envisioned by the Town of Richmond Hill for the area around the station, a stand-alone PPUDO facility would not be the most appropriate use of land in the context of the Town's land use plan and policies for the area. Therefore, the most appropriate approach to configure the PPUDO facility is to incorporate it into future Transit-Oriented Development adjacent to the station – with a view of minimizing its land requirement while maximizing its functionality in relations to the station. Configuration of the PPUDO will be determined in the next stage of design.

11.9 Utilities and Relocation Strategy

Due to the uncertainty of the bus terminal, an overall utility relocation strategy was not developed.

To facilitate construction of the crossover box south of the station, the existing concrete box culverts which inlet to the stormwater management pond must be relocated.



- LEGEND**
-  ROAD
 -  ELEVATED ROAD
 -  PUBLIC AREA
 -  SERVICE ROOMS
 -  VERTICAL CIRCULATION
 -  RETAIL
 -  LANDSCAPE AREA
 -  NORMAL OPERATION EXIT WAY

LOCATION PLAN
 SCLE 1:5000

1
001A

DRAWING No. SHEET No. FILE BLDG. REF. No.

REVISIONS	REVISIONS

CONCEPTUAL DESIGN
 NOT FOR CONSTRUCTION

DRAWN _____
 CHECKED _____
 CORRECT _____
 SCALE 

YONGE SUBWAY EXTENSION
RICHMOND HILL CENTRE STATION
 LOCATION PLAN

Plot Date: 8/26/2011

 TORONTO TRANSIT COMMISSION
 ENGINEERING DEPARTMENT
 Dwg. No. **SK-A-001A** Sheet No.

Table 12-1: Technical Comparison of Bridge Alternatives

TECHNICAL COMPARISON OF BRIDGE ALTERNATIVES ¹							
here	ALTERNATIVES	Alternative 1	Alternative 2	Alternative 3	Alternative 4	Alternative 5	Alternative 6
	BRIDGE TYPE	CPCI Precast Girder + Steel Plate Girder	Steel Plate Girder + Haunched Steel Plate Girder	Steel Truss	Tubular Deck Arch	Through Arch	Prestressed Post-tensioned Girder
Evaluation Criteria							
1	STRUCTURAL CHARACTERISTICS						
1.1	FUNCTIONALITY	●	●	●	●	●	●
1.2	REDUNDANCY	●	●	●	●	●	●
2	CONSTRUCTION ISSUES						
2.1	CONSTRUCTABILITY	●	●	●	●	●	●
2.2	CONSTRUCTION DURATION	●	●	●	●	●	●
2.3	AVAILABLE SPACE FOR CONSTRUCTION	●	●	●	●	●	●
3	LONG-TERM MAINTENANCE						
3.1	DURABILITY/MAINTENANCE	●	●	●	●	●	●
3.2	EASE OF INSPECTION	●	●	●	●	●	●
4	SIGNATURE STRUCTURE QUALITIES						
4.1	SIGNATURE STRUCTURE QUALITIES	●	●	●	●	●	●
5	COSTS						
5.1	STRUCTURE COST	●	●	●	●	●	●
	Structure Capital Costs	\$10 - \$15 M	\$15 - \$20 M	\$25 - \$30 M	\$30 - \$35 M	\$35 - \$40 M	\$30 - \$35 M
	Highway Capital Costs (Closed Median Cost Premium)	—	—	—	—	—	—
	75 Year Life-cycle (Structure Only)	—	—	—	—	—	—
PRELIMINARY RECOMMENDATIONS							
PREFERRED ALTERNATIVE FOR FURTHER DEVELOPMENT			X			X	

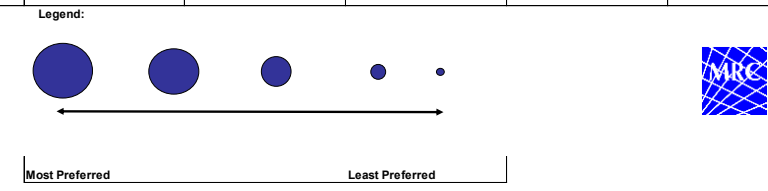

12. EAST DON RIVER BRIDGE

The preferred crossing of the East Don River is a bridge comprised of an elevated structure for both the subway and the roadway - with the roadway running on top and the subway below the road surface. The subway crosses the river on the bridge structure and continues underground north and south of the river valley.

The characteristics of the bridge should reflect the heritage nature of the surrounding area, address noise concerns, and preserve access to the local golf clubs and other entrances along Yonge Street.

The bridge construction and the removal of the existing roadway embankment offer the opportunity to restore the East Don River valley and reconnect the east and west sides of the valley.

12.1 Alternatives Considered

A full range of bridge types, construction materials and span lengths were considered, compared and evaluated for constructability, construction cost, and aesthetics. Pre-tensioned and post-tensioned concrete construction was compared with structural steel construction for the superstructure in order to determine the most suitable material. Reinforced concrete construction was considered for the piers and abutments to support both the steel and concrete alternatives for the superstructure.

All of the structural options and span arrangements investigated have a very similar overall bridge length, alignment, and approach configurations as the concept developed during the TPAP.

12.1.1 SPAN ARRANGEMENTS

The number of spans in any bridge crossing directly affects the total construction cost of the bridge. Generally, the longer the spans of a bridge the greater the construction cost of the bridge superstructure. However, for a given length of bridge, longer spans will require the construction of fewer piers, resulting in a lower construction cost for the bridge substructure. Since the total cost of a bridge is the sum of the costs of the substructure and superstructure, consideration was given to examine a range of spans to identify the least expensive overall cost.

For the structural steel superstructure construction, single and three span bridge configurations were evaluated. For the concrete superstructure, three and five spans alternative were evaluated. Various options considered during the course of the study are briefly outlined as below:

- Option 1: Pre-Stressed Girders (Five Spans)
- Option 2: Steel Plate Girder (Three Spans)
- Option 3: Steel Truss (Three Spans)
- Option 4: Tubular Steel Arch (Single Arch Multi-Span)
- Option 5: Steel Through Arch (Single Span)
- Option 6: Post-Tensioned Box (Three Spans)

A summary of the comparison of these six options is presented in **Table 10-1**.

12.1.2 SUPERSTRUCTURES

12.1.2.1 STEEL PLATE GIRDER

For the structural steel superstructure alternatives, welded plate girder construction has been evaluated and compared to other types such as truss and through arch construction to support the proposed reinforced

concrete bridge deck. Configuration of three spans (45m-55m-45m) was investigated for plate girder construction. The steel truss and through arch structures types are discussed in the sections 12.1.2.3 and 12.1.2.5 respectively.

For the plate girder construction alternative, consideration was given to vary the depth of the girders to produce an attractively curved profile for the underside of the bridge although it might not be the most economical solution.

The steel box girders were not considered to support the deck and thought to be less structurally efficient than the three plate girders. This is due to the fact that the costs of fabricating, shipping and erecting the more complex and bulky boxes are generally considered to be greater than those for the plate girders.

This alternative is considered to be an economical and aesthetically pleasing option. In addition, this is one of the options thought to be preferred by the key stakeholders, as this alternative offers an opportunity to complement existing heritage characteristics by incorporating heritage design details into the final design of the bridge structure.

12.1.2.2 PRE-STRESSED CONCRETE GIRDER

Concrete construction is often less expensive than steel construction for bridges with shorter span lengths. For this reason, five (5) span, (27m-32m-32m-27m) configuration, using pre-stressed concrete 'I' girder construction for the superstructure, was investigated for cost effectiveness.

Concrete construction produced the lowest cost for the structure. Unfortunately, the environmental and aesthetical considerations of the additional piers required to achieve such short spans made this alternative non-competitive with steel construction. Additional piers in the valley are unlikely to provide an aesthetically pleasing solution and less likely to be preferred by Toronto Region Conservation Authority as the steel construction would have a significantly smaller footprint than the pre-stressed concrete alternative.

It was concluded that the construction of a concrete superstructure for the Don River Bridge would not be considered for further development.

12.1.2.3 STEEL TRUSS

This three span continuous truss has spans of 48m, 60m and 48m for a total length of 156m. The 6.45m constant depth trusses spaced 6.75m centre to centre provide a usable deck width of 26.95m with concrete barriers on each side. A 3m combined width for sidewalk and bike lane cantilevers from the outside of the trusses on each side of the bridge. Continuous through trusses carry the floor system, which is composed of a 250mm thick conventionally-reinforced concrete deck, simply supported composite stringers and a plate girder floor system. A parallel chord arrangement rather than a variable depth scheme was considered to facilitate erection. The substructure for the middle span consists of two piers located well outside the existing watercourse.

It was concluded that the construction of a through truss superstructure for the Don River Bridge would not be an economical or an aesthetically pleasing option in comparison with the steel girder construction.

12.1.2.4 TUBULAR STEEL ARCH

The 120m long double deck tubular arch bridge has a 64m arch span which provides clearance over the Don River. The structural system is unusual; the deck is supported on four tubular arches. This alternative is composed of four tubular arches at a typical spacing of 7m and of steel tube columns. At the apex of the arch the deck slab is connected to the arch tubes in a shear stiff manner. The connection between arch tube and columns is welded. The connection of the columns with the superstructure and the foundations is rigid. Arch springs are considered to be clamped to the abutments using pre-stressing bars by means of heavy base plates and stiffeners provided at the main tube ends. The deck slab rests on the arch in the middle region and on columns at the approach regions.

The analysis and structural detailing of the bridge would be quite demanding. Steel Tubular arch bridges are rarely built, because they are considered to be costly and require particular care during erection. In general, this type of structure is appreciated for its high aesthetic value. As pure and simple as these structures may seem, the nodes are difficult to build and comprise various types of stress concentration and extreme lowering of the fatigue strength of the tubular arch bridge of which they are a part. This stress concentration is typically overcome by nodes made from cast steel; casting of nodes mainly mitigates the stress concentrations caused by welding.

A characteristic of steel arches, in general, is concern with the achievement of thrust force after erection. It is imperative that, after erection, the dead weight also contributes to the total thrust force and this may require special erection procedures.

This form of construction is unlikely to have any local previous experience and require specialist input during design and construction. This option is not considered for further development at this stage as it is unlikely to be an economical option and there is likely a lack of expertise for construction.

12.1.2.5 STEEL THROUGH ARCH

The superstructure of this alternative comprises three steel through arches supporting the double deck structure. The span length of the arch is 115m and the arch rise is 20m. The road deck of the bridge accommodates five traffic lanes, 3.5m each, and two 3m wide combined sidewalk and bike lanes. The bridge deck is constructed of steel beams grillage and a 200mm thick concrete slab. Bracing will be provided between the arches to provided lateral stability and strength. Flexible hangers carry the bridge floor system.

The bridge abutments rest on the pile foundations. The abutments will be subjected to intensive horizontal thrust force, and thus the use of battered piles is unavoidable for this reason.

Although this option is more expensive to build, this option is thought to be one of the preferred options as this alternative is highly visual and it increases the potential for a change in character of the heritage district.

12.1.2.6 POST TENSIONED BOX

This crossing alternative is a three (3) span 45m-55m-45m, 7.2m deep, three-cell, pre-stressed concrete box-girder structure. The northbound and southbound subway tracks are located within the outer cells of the

bridge. This option is not considered for further development as it has little aesthetic value and minimal opportunity to incorporate heritage features.

12.1.3 BRIDGE DECK

For each of the superstructure alternatives studied, a constant thickness, reinforced concrete deck has been assumed. The concrete deck will extend uninterrupted between abutments on the structurally continuous superstructure. Expansion joints will be installed at the abutments only where all bridge movements will be accommodated. Eliminating expansion joints from intermediate locations within the deck reduces the maintenance efforts on the bridge and minimizes the number of deck elements which interfere with snow plowing operations.

During the detailed design stage, consideration will be given to use precast, pre-stressed concrete stay-in-place deck panels. This could reduce the cost of deck construction since the contractor does not have to strip the usually difficult to remove deck formwork.

12.2 Substructure and Foundations

The detailed soils investigation has confirmed the presence of bed rock below sandy gravel/ sandy silt deposits at an elevation of 135m at the south abutment end and at an elevation of approximately 145m at the north abutment. The reasonably close proximity of the rock makes it feasible to construct the pier foundations such that they are embedded into its upper competent layers. Consideration should be given during detailed design to using large diameter steel pipe piles/caissons to support the pier footings above the riverbed as a means of reducing the cost of the foundations.

12.3 Bridge Aesthetics

The overall appearance of the bridge and visual impact it will have on York Region has received special attention during this preliminary design study. Care has been taken to select structurally efficient and economical structures that will also harmonize with the existing character/heritage features of the region.

Consultation with key stakeholders will be included during the detailed design phase, with a view of ensuring that relevant heritage features are included on the bridge and in its proximity to blend in and harmonize with the local area.

12.4 Structural Design

The bridge will be designed in accordance with the latest version of Canadian Standards Association (CSA) S6 Canadian Highway Bridge Design Code (CHBDC) for a minimum live (traffic) load of CL625 and subway car loading in accordance with the TTC design manuals. The CHBDC contains provisions for a range of loads and forces appropriate for the geographic location under consideration to be applied to the bridge structure. These can include traffic, earthquake, wind, ice, water and vehicle collisions, to be applied in a number of different combinations.

Consideration should be given to design the lower deck of the bridge to carry the Tunnel Boring Machine (TBM) across the Don River. This may be dictated by the need to meet the overall project schedule so that continuous tunnel boring operations take place with minimal delay or cost.

All materials and components installed in the bridge will be selected, designed and specified to provide a minimum design life of 75 years.

12.4.1 FOOTINGS

Based on the geological conditions, concrete footings supported on piles have been selected for the abutments and piers of the bridge. The abutments footing will be substantially smaller substructure elements than the piers. The footings will be supported on steel piles and will be protected against scour and erosion by riprap.

12.4.2 ABUTMENT AND PIER

Reinforced concrete abutments will be constructed at the ends of the cut and cover approach tunnels. The abutments are to be supported on steel piles drilled or driven through the sandy gravel/sandy silt deposits to refusal at, or slightly into, the underlying bedrock. The pile type, number per abutment, and method of installation will be determined at the detailed design stage.

The reinforced cast-in-place concrete piers required for a plate girder option are to be socketed into the bedrock.

12.4.3 SUPERSTRUCTURE

Whenever possible, the superstructure should be a redundant design. A redundant structure has multiple load paths available to share the loads should a single member fail. Non-redundant structures are fracture critical. Fracture-critical designs should be avoided. If a design contains fracture-critical members, these members must be specifically identified on the plans.

The above criteria were taken in to account in developing the six bridge alternatives included in this report. Option 1 & 2 are considered to be redundant structures with multiple load paths. However, options 3, 4, & 5 are considered to be Non-redundant structures and associated risks should be managed in accordance with the bridge code S6 during the detailed design phase.

The bridge superstructure will consist of viewing platforms and a sidewalk located on both the upstream and downstream sides of the bridge to encourage/provide viewing/photo opportunities.

12.5 Bridge Finishes

The structural steel for the girders will be atmospheric corrosion resistant (ACR) steel to eliminate the need for painting and eventual maintenance repainting, to the extent possible. ACR steel initially corrodes but the corrosion layer tightly adheres to the underlying steel and prevents atmospheric corrosion from progressing further.

As de-icing chemicals can destroy protective rust coating, steel located in areas that could be exposed to such chemicals (generally within about 3 m of each deck joint) will require a paint coat protection that would be applied to the steel prior to delivery to the site. Since the bridge's superstructure girders are to be fabricated from ACR steel, they will not require repainting except for the very short sections adjacent to the area of the expansion joints. These joint paint sections are expected to require repainting approximately every 15-20 years. When these sections are being repainted, standard containment procedures will be followed so as to capture all old paint, expended abrasives, and new paint overspray, and to prevent their entry into the watercourse.

12.6 Navigational Requirements

Navigation clearance requirements will be established by the Canadian Coast Guard via a public consultation process, as required by the Navigable Waters Protection Act (NWPA), and a formal application will be made consistent with the time frames stipulated within the NWPA for commencement and completion of the construction.

12.7 Bridge Construction

12.7.1 PLATE GIRDER OPTION

Preliminary design indicates a maximum girder depth of 2m and each girder line will consist of a number of sections of girder joined together in the field by high strength bolted splice connections.

Shipping dimensions and handling weights will dictate the actual number of sections required in each girder line. Based on past experience, it is expected that there will be 5 to 6 sections per girder with a maximum individual length of around 27 metres. It is anticipated that the steel girders would be produced in certified bridge fabrication facilities in southern Canada and shipped to the site for erection.

The actual steel erection technique selected will depend to some extent on the eventual schedule and timing of the construction. Whichever erection technique is adopted, a detailed engineering procedure will be developed to ensure both the safety of the erection and to avoid any adverse effects on the completed structure. In some instances local strengthening or temporary bracing of the girders may be required specifically to ensure the safety of the erection process. The erection procedure adopted will be the responsibility of the contractor and be independently reviewed by the design consultant.

One possible scenario would be to utilize temporary erection towers located between the permanent substructures to support the sections of girder while the bolted splice connections are completed.

Following the completion of the steel erection, preparation is made for the placement of the deck concrete. A series of plywood forms supported by falsework will be constructed between the steel girders. The deck reinforcing steel will then be placed and the deck concrete poured in a number of discrete sections.

12.7.2 STEEL THROUGH ARCH OPTION

Construction thrust blocks at both ends will be undertaken first. Once completed, the two arch ribs in accordance with the proposed construction staging will be erected. These arch ribs will likely be fabricated

using induction bending to create the required compound curvature. The arches are likely to be erected in two pieces and welded together on site. Temporary bent/trestle supports will be required to undertake the arch installations.

12.7.3 CONSTRUCTION STAGING

The traffic staging plans will be developed during the preliminary and detailed design phases in consultation with York Region, the City of Vaughan, the Town of Markham and the Toronto Transit Commission. A preliminary traffic staging concept is considered to be feasible as reported below:

- *Construction Stage 1:* A four (4) lane detour and a pedestrian walkway will be constructed on the west side of the Yonge Street. The existing East Don River culvert extends far enough from Yonge Street to accommodate 4 lanes of traffic and 2m of construction clearance. A temporary bridge to accommodate pedestrians across the East Don River may be required. Traffic will remain on Yonge Street.
- *Construction Stage 2:* The bridge and north bound approaches will be constructed. Traffic will circulate on the four (4) lane detour built in Stage 1.
- *Construction Stage 3:* The bridge and southbound approaches will be constructed. Northbound traffic will circulate on the new bridge; southbound traffic will use the detour.

12.8 Construction Schedule

The construction of a bridge across the Don River at Yonge Street presents numerous scheduling challenges as follows:

- To provide access to allow a TBM to cross the Don River to maintain continuous tunnel boring operations;
- To accommodate traffic staging requirements in order to maintain the existing traffic on Yonge Street; and
- A constrained construction site which will be relatively congested.

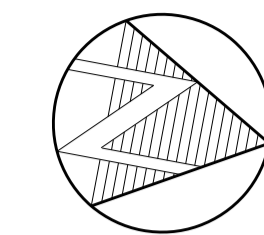
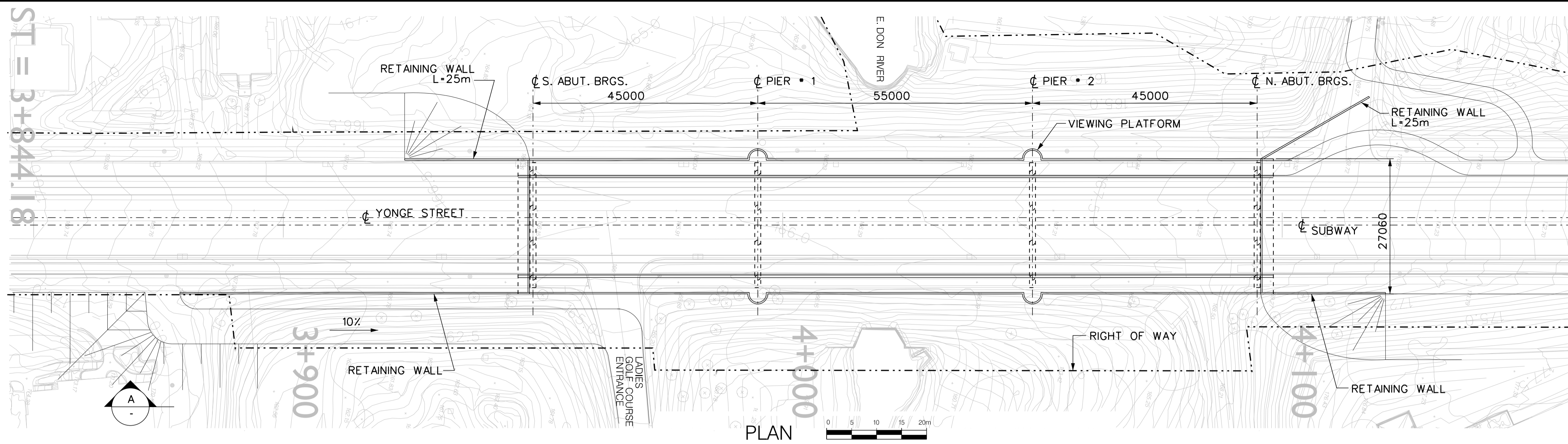

NOTES

1. CLEAR SPACING ABOVE TOP OF EXISTING CULVERT IS APPROXIMATELY 100MM.
2. THIS OPTION NEEDS TO RAISE APPROXIMATELY 1.7M OF YONGE STREET PROFILE BASED ON EA STUDY TO ACCOMMODATE PRECAST CONCRETE GIRDERS, AND TO RE-ALIGN LADIES GOLF COURSE ENTRANCE.

LEGEND

----- RIGHT OF WAY

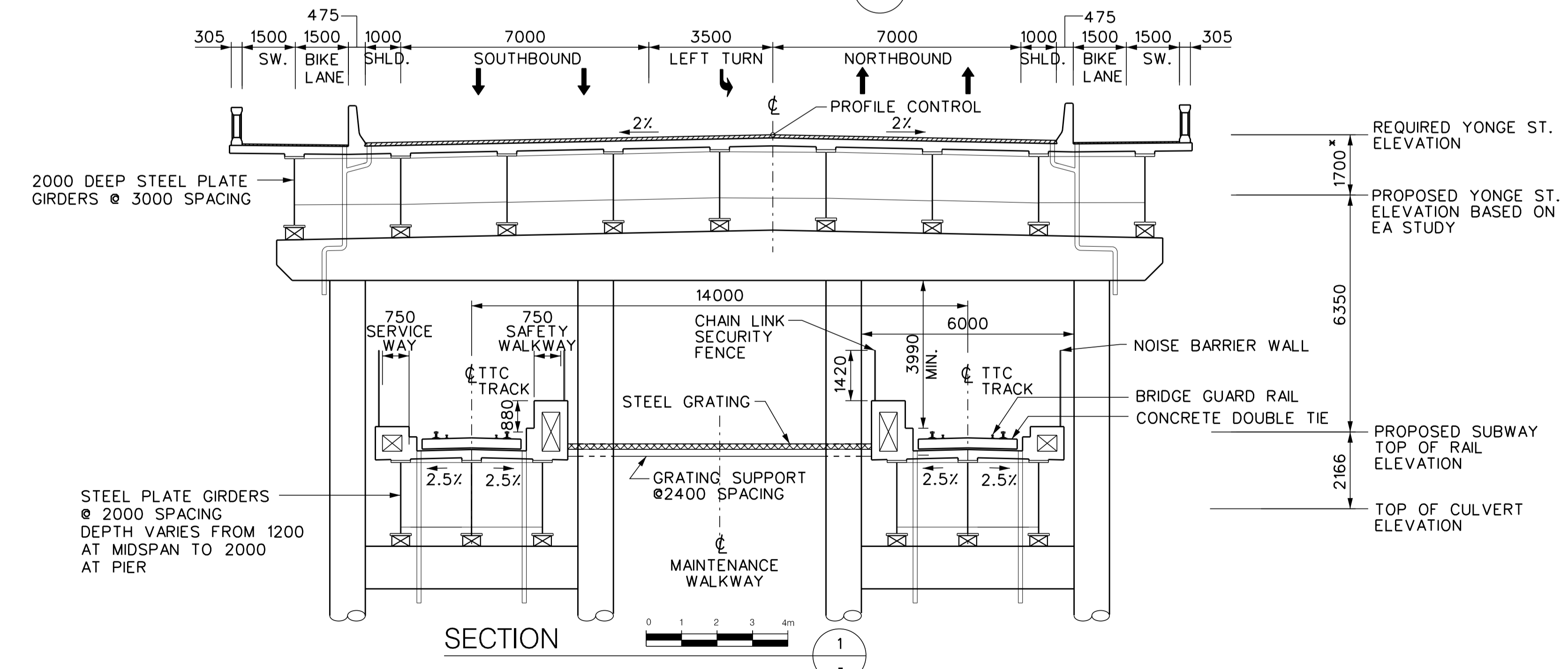
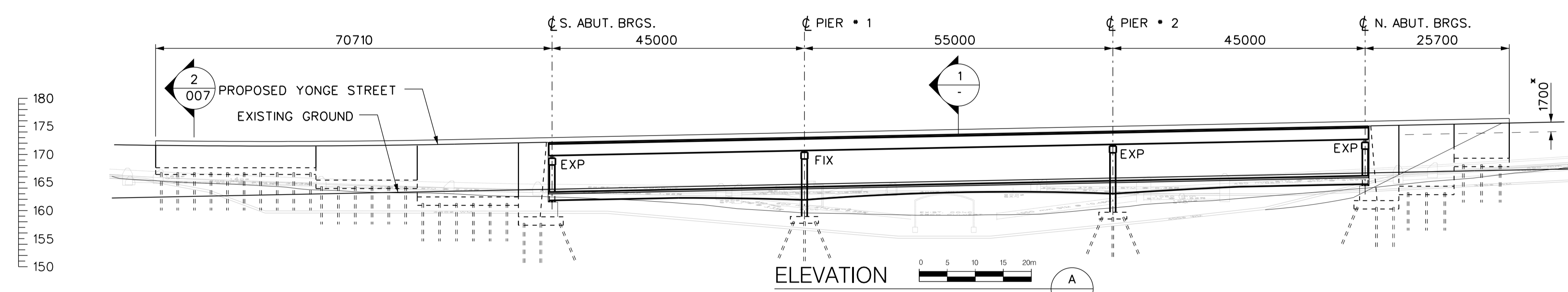

REVISIONS



DRAWN B. TULECKA
 CHECKED G. JEYAGOBY
 CORRECT
 SCALE

YONGE SUBWAY EXTENSION
 EAST DON RIVER BRIDGE
 OPTION 2

Plot Date: 19/10/2011

TORONTO TRANSIT COMMISSION
 ENGINEERING DEPARTMENT

Dwg. No. Sheet No. 002

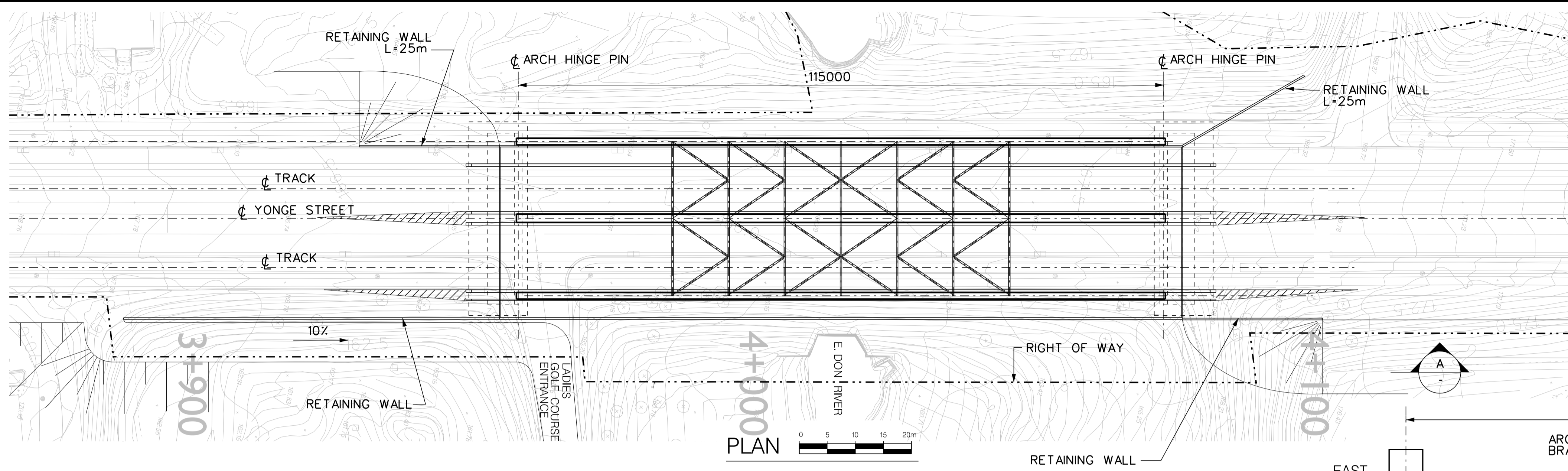

NOTES

1. CLEAR SPACING ABOVE TOP OF EXISTING CULVERT IS APPROXIMATELY 300mm.
2. THIS OPTION NEEDS RE-ALIGNMENT OF LADIES GOLF COURSE ENTRANCE.

LEGEND

--- RIGHT OF WAY

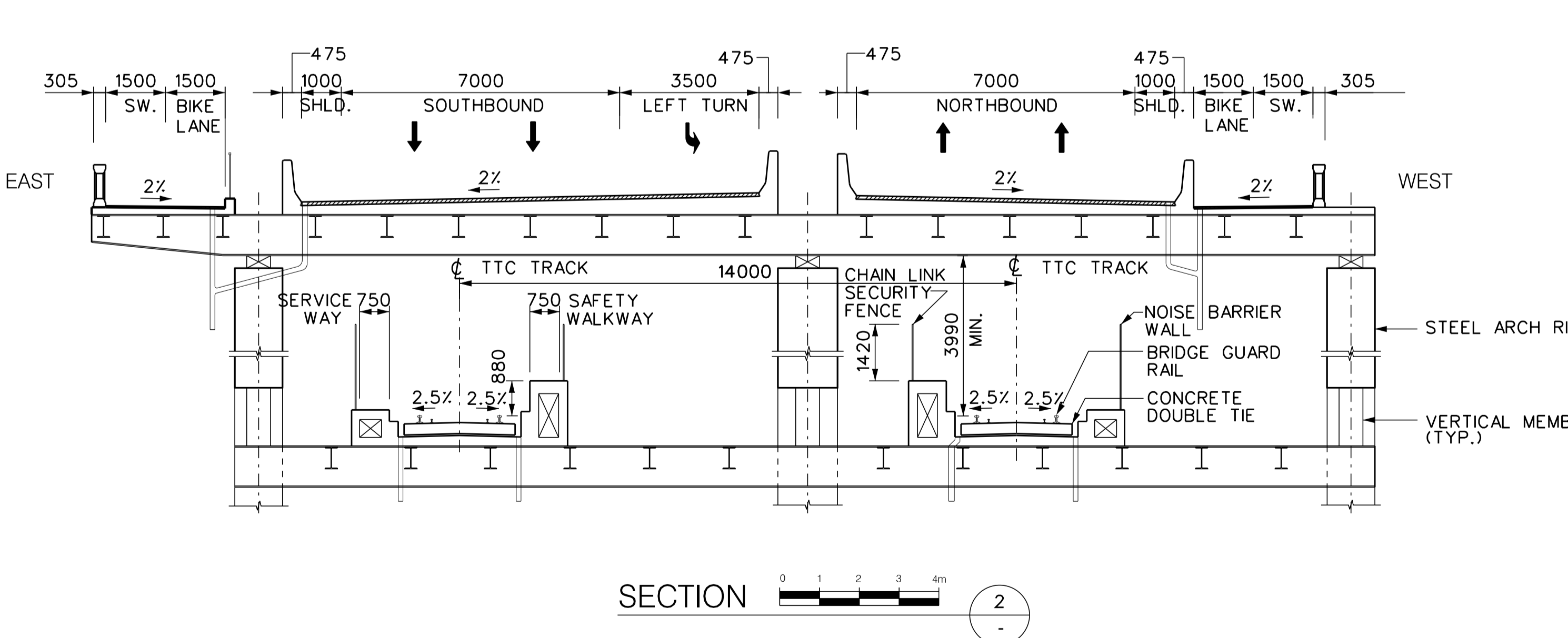
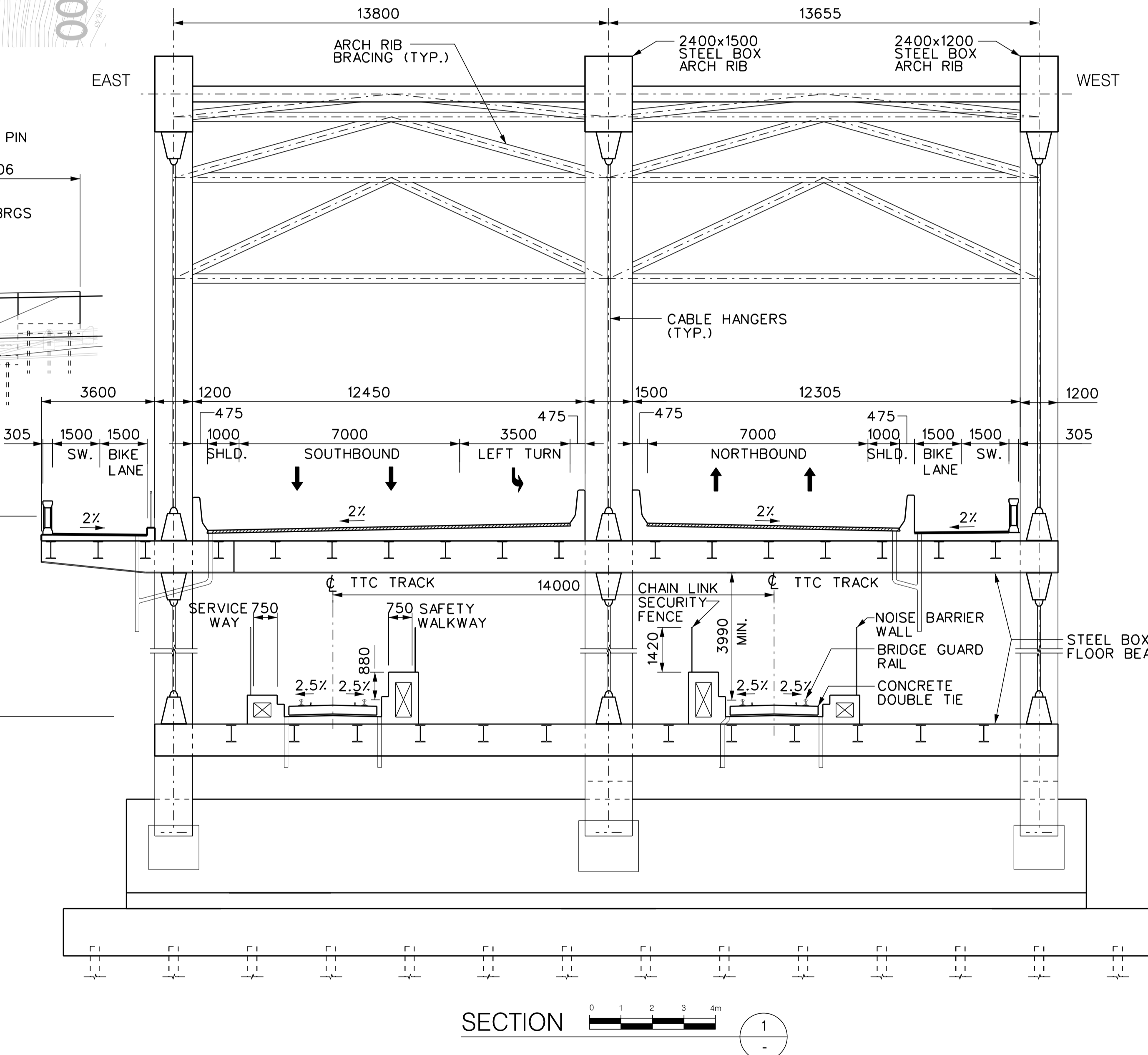
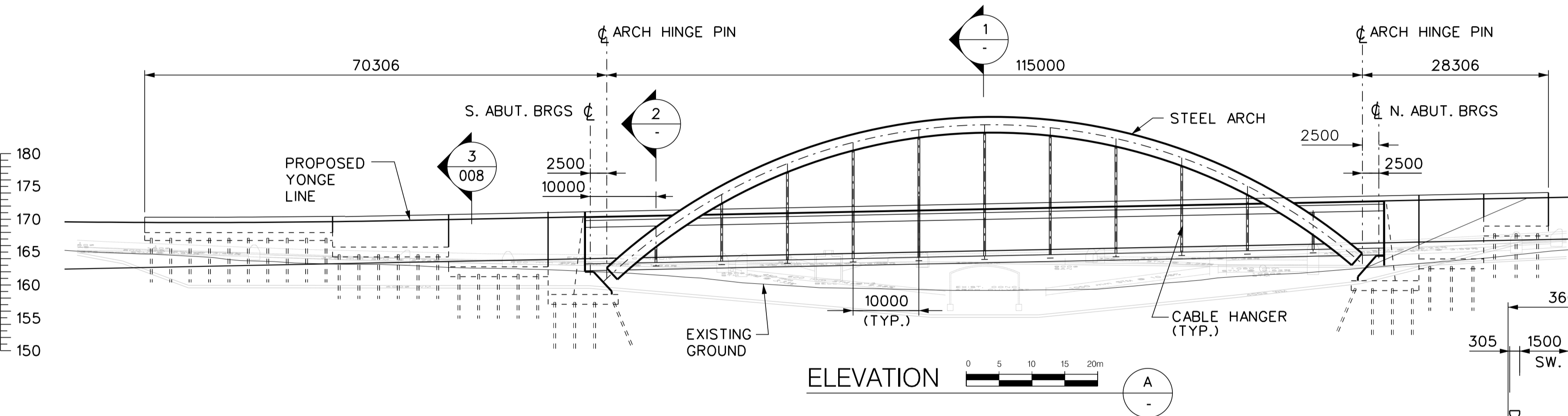

REVISIONS



DRAWN: B. TULECKA
 CHECKED: G. JEYAGOBY
 CORRECT: _____
 SCALE: AS SHOWN

YONGE SUBWAY EXTENSION
 EAST ARCH BRIDGE
 OPTION 5

Plot Date: 19/10/2011

 TORONTO TRANSIT COMMISSION
 ENGINEERING DEPARTMENT
 Dwg. No. _____
 Sheet No. 005

13. TRAIN STORAGE AND MAINTENANCE FACILITY

In 2009-2010, the TTC undertook a review of the subway rail yard needs for the Yonge Subway to the year 2030; it was determined that the car fleet would grow from 62 trains to a total of 88 trains. The increase would be driven by the following key factors:

- A gradual increase in service frequency with ATO;
- The additional fleet needed for the Toronto-York Spadina Subway extension (TYSSE);
- The Yonge Subway Extension fleet (YSE) from Finch Station to Richmond Hill Centre Station, and
- The relocation of the current Spadina Subway short turn from St. Clair West Station to Glencairn Station.

The implication for the Yonge Subway Extension is the need for a 14-car train storage facility in the area of Richmond Hill Centre (scope included in the Conceptual Design) and consideration be given to the purchase of yard property for fleet growth beyond 2030 (scope not part of current Conceptual Design).

The implementation of any train storage facility will be the subject of a separate TPAP as it was not included as part of the YSE TPAP. The requirement for train storage at the north end of the Yonge line was identified by TTC after the YSE TPAP was completed and approved by the MOE.

13.1 Planning Requirements and Design Considerations

Primary maintenance for the Yonge Subway Extension will continue to be at Wilson Yard located south of Downsview Station. However, overnight train storage will be provided in the area of Richmond Hill Centre Station and within an underground train storage facility where light-duty maintenance and cleaning of the subway vehicles will occur.

The determination that a 14-car train storage facility in the area of Richmond Hill Centre was a requirement for the Yonge Subway Extension was premised on four trains being displaced from the current Finch Station and an additional 10 trains being necessary to meet the service requirements for the extension. During preliminary assessment of this need, it was concluded that two trains could be stored at Richmond Hill Centre Station and the remaining 12 trains would be stored in a below grade facility. This facility would be used for overnight storage and light cleaning of the vehicles.

Several alternatives were developed for the storage facility including options which extended under Yonge Street north of the Langstaff Station, under the Commuter Parking Lot within the hydro corridor and extending easterly within the hydro corridor north of Highway 7. Several alternatives were also developed which extended the subway line north of Richmond Hill Centre Station.

Design considerations for the train storage facility were as follows:

- The next station on the line, forming part of a future northern extension, should be located in close proximity to the Yonge Street/16th Avenue intersection
- The facility should be designed in a way that any future construction of a northerly extension should not impact or disrupt train storage or train operation

- The facility should be designed in a way that will allow easy conversion of the train storage facility for future revenue service

13.2 Alignment and Configuration

Based on a high-level screening, three alignment alternatives were developed for detailed assessment. These included:

- Alignment Bi - construction of a three-track structure extending north from the Richmond Hill Centre Station adjacent to the existing CN Rail corridor;
- Alignment Cii - construction of a two-track storage tunnel extending north from the Richmond Hill Centre Station and curving westerly to run under the Yonge Street road alignment, and
- Alignment Gi - construction of a four-track storage structure extending north from the Richmond Hill Centre Station adjacent to the existing CN Rail corridor.

Consistent with the methodology used for the YSE Transit Project Assessment, a matrix (see **Table 11-1**) documents the evaluation of these various alignment alternatives. Alignment Bi (see **Figures 11-1 and 11-2**) has been selected as the recommended alternative. It should be noted that the final alignment of the train storage facility has been influenced by the need to avoid the existing caisson foundations for the condo located at 29 Northern Heights Drive and the need to establish tunnel/station easements for proposed new developments by landowners on the east-east side of Yonge Street south of 16th Avenue. The final alignment of the train storage facility does encroach on the current CN ROW and a subsurface easement will be required.

13.3 Operational Requirements

The following operational requirements were compiled following several meetings with TTC Subway Operations:

- The facility will be below grade/enclosed and will be used for overnight storage and light maintenance interior cleaning and repairs, as well as off-peak storage (i.e. trains are not expected to deadhead to any other yards on YUS during off-peaks);
- Maintenance crew will access/egress the underground facility from the Richmond Hill Centre Station Platform or from EEB #8 provided at the north end of the train storage facility;
- Trains entering revenue service will be delivered by maintenance crew to the south end of the Richmond Hill Centre Station platform to be picked up by the operator, and
- The facility will be staffed overnight to perform preventative maintenance diagnostic checks (self-diagnostics) and to provide a permanent presence (overnight security) in the facility.

13.4 Facility Requirements

The following facility requirements were similarly developed with TTC Subway Operations:

- A transportation reporting centre;
- A parking lot for 25-30 spaces premised on 13-14 people needed to bring trains into operation;
- Cargo elevator;
- Garbage storage room, and
- Small lunch room and locker room

An assessment of the traction power and electrical requirements for the train storage facility (see Appendix 'C') has identified the need for an Electrical Service Building including a high voltage room, communication room, emergency power room, HVAC mechanical room and a switchgear-switchboard room.

An assessment of the ventilation requirements for the Yonge Subway extension including the train storage facility has identified the need for an emergency ventilation fan, a fan room and a ventilation shaft to be located at the north end of the train storage facility. These various facility requirements are indicated in **Figure 13-1**.

Table 13-1: Technical Comparison of Train Storage Facility Alignment Alternatives

Measure		Note	Alternative Bi	Alternative Cii	Alternative Gi
	Description		Construction of a 3-track storage structure extending north from the Richmond Hill station adjacent to the existing CN Rail corridor.	Construction of a 2-track storage tunnel extending north from the Richmond Hill station and curving westerly to run under the Yonge Street road alignment	Construction of a 4-track storage structure extending north from the Richmond Hill station adjacent to the existing CN Rail corridor.
1.0 Train Storage Facility					
1.1	Land use types adjacent to storage facility	General description	Mostly residential to the west. CN rail corridor to the east.	Residential and commercial on both sides	Mostly residential to the west. CN rail corridor to the east.
			●	●	●
1.2	Construction method required	General description	Cut-and-cover between CN rail corridor and residential properties	Tunneling under residential properties from Beresford Drive to 60m north of Oak Avenue/Northern Heights Drive.	Cut-and-cover between CN rail corridor and residential properties (wider construction area than Alternative Bi)
			●	●	●
1.3	Traffic impacts as a result of cut-and-cover construction	Preliminary assessment	Low - requires partial lane closure on Coburg Crescent and Beresford Drive. Access to residential properties can be maintained.	Low to Medium - requires lane closures on Yonge Street around Oak Avenue	Low - requires partial lane closure on Coburg Crescent and Beresford Drive. Access to residential properties can be maintained.
			●	●	●
1.4	Number of buildings and structures within the tunnel easement	tunnel easement defined as a 30 to 32m swath centred on tunnel reference line			
		Commercial - Office	1 (50 High Tech)	1 (50 High Tech)	1 (50 High Tech)
		Commercial - Retail	0	1	0
		Residential - Townhouse Units	0	53	0
		Overpass	1 (Bantry Avenue)	0	1 (Bantry Avenue)
			●	●	●
1.5	Number of potential noise and vibration sensitive receptors within 100m of the storage facility	Preliminary - to be confirmed by future studies	210 townhouse units 4 apartment buildings	179 townhouse units 4 apartment buildings	121 townhouse units 2 apartment buildings
			●	●	●
1.6	Horizontal and vertical alignments - compliance with TTC Design Standards		Complies with technical design standards	Complies with technical design standards	Complies with technical design standards
			●	●	●
1.7	Approx. length of storage facility		820 metres	1049 metres	630 metres
			●	●	●
1.8	Encroachment on CN rail corridor		No	No	Yes
			●	●	●
1.9	Location of ancillary facilities (e.g. staff parking, office, ventilation shafts, EEBs, etc.)		Can be accommodated within the train storage facility easement between the adjacent townhouses and the CN rail corridor.	Will need to be accommodated off Yonge Street on existing commercial/retail properties on the west side of Yonge Street - commercial/business impact.	Can be accommodated within the train storage facility easement between the adjacent townhouses and the CN rail corridor.
1.10	Construction Cost		Initial review would indicate similar capital costs for all 3 alternatives.		
1.11	Residential Property Acquisition Cost	Based on the number of units affected (See 1.4) multiplied by average neighbourhood sales price between April 2010 and April 2011. Intended for qualitative comparison only - does not represent actual property acquisition cost.	No residential property acquisition anticipated	\$22,655,000	No residential property acquisition anticipated

Measure	Note	Alternative Bi	Alternative Cii	Alternative Gi
2.0 Future Subway Extension to 16th Avenue				
2.1	Centroid of the station platform relative to centre of the intersection Location of the future 16th Avenue Station relative to the intersection of Yonge Street and 16th Avenue	120 metres east of the intersection	At the intersection	120 metres east of the intersection
	Option Cii situated at equal distance between Hillcrest Mall and South Hill Plaza station box could straddle the intersection or positioned further north to connect with any preferred entrance location.	●	●	●
2.2	Number of redevelopment sites bisected or crossed by tunnel easement	2 (Great Lands, Haulover)	0	2 (Great Lands, Haulover)
	Despite the subway tunnels crossing the development sites, consultation with land owners indicated that impact on site plan and built-form will be minimal.	●	●	●
2.3	Number of buildings and structures within the tunnel easement			
	tunnel easement defined as a 30 to 32m swath centred on tunnel reference line			
	Residential - Townhouse Units	37	0	37
	Residential - Condominium Units	198	0	198
		●	●	●
2.4	Horizontal and vertical alignments - compliance with TTC Design Standards	Complies with technical design standards	Complies with technical design standards	Complies with technical design standards
		●	●	●
2.5	Construction method required	General description	Tunneling under residential properties from the north end of the storage facility to the station box at 16th Avenue. Cut-and-cover for station box.	Tunneling or cut-and-cover for 250 metres of tunnels between the north end of the storage facility and 16th Avenue Station. Cut-and-cover for station box.
		●	●	●
2.6	Future subway construction allowances (ie future TBM exit shaft or future ventilation shafts)	Yes	Yes (extraction shaft within Yonge Street ROW)	Yes
		●	●	●
2.7	Impact of future extension to 16th Avenue on the train storage facility	Storage facility must be relocated in the future	Storage facility must be relocated in the future	Storage facility must be relocated in the future
2.8	Impact on subway turnback operation at Richmond Hill Centre Station	Permits provision of double-ended pocket tracks north of the station platform. Two turnback options. Can accommodate train headways that are less than 3 minutes and 30 seconds.	Excludes the ability to provide double-ended pocket tracks north of the station platform. One turnback option. Limits the ability to operate trains at headways less than 3 minutes and 30 seconds.	Permits provision of double-ended pocket tracks north of the station platform. Two turnback options. Can accommodate train headways that are less than 3 minutes and 30 seconds.
		●	●	●
2.9	Additional Tunnelling Cost to Extend to Future 16th Avenue Station (2011\$)	\$22 Million (430 metres)	\$13 Million (250 metres)	\$31 Million (620 metres)
	Excludes station at 16th Avenue. Based on length of tunnels multiplied by unit cost for twin tunnelling (\$50,000 per metre). Includes tunnel boring, tunnel liners, and finishes only. Does not include contingencies or mark-ups.			
2.10	Residential Property Acquisition Cost (2011\$)	\$17,848,000	No residential property acquisition anticipated	\$17,848,000
	Based on the number of townhouse units affected (See 2.3) multiplied by average neighbourhood sales price between April 2010 and April 2011. Intended for qualitative comparison only - does not represent actual property acquisition cost. Includes a \$5 Million placeholder for monitoring/remedial work on condo at 29 Northern Heights Drive.			

SUMMARY	●	●	●
----------------	---	---	---

Legend			
●	●	●	●
Least Preferred			Most Preferred

Figure 13-1: Proposed Train Storage Facility (Alignment Bi, Plan View)

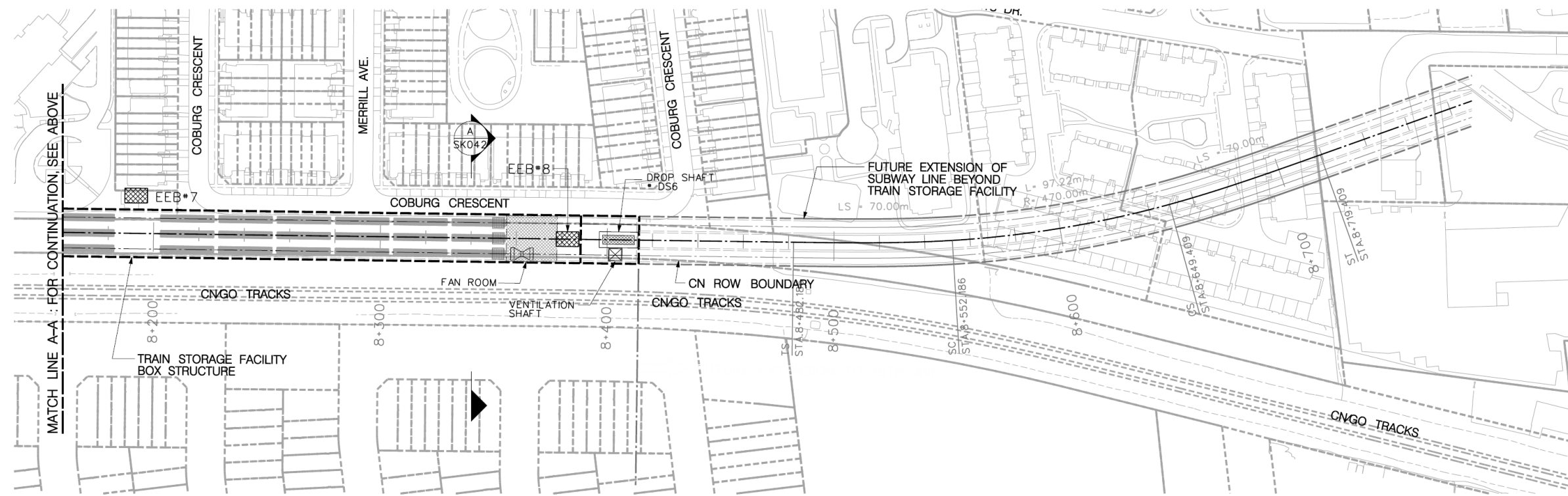
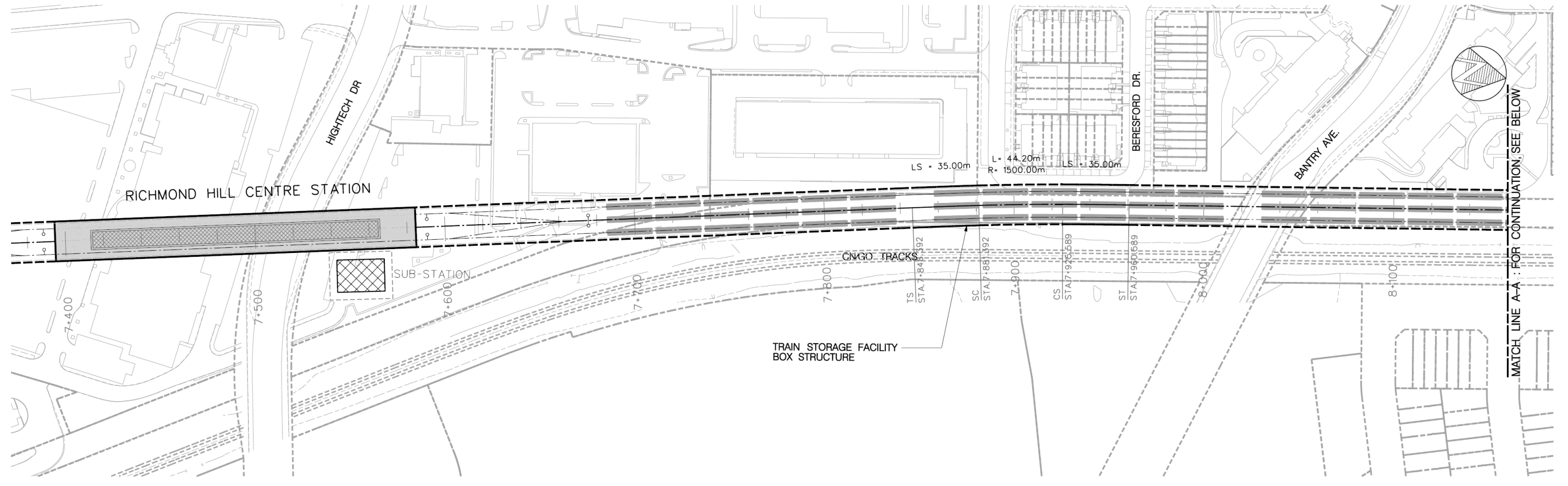
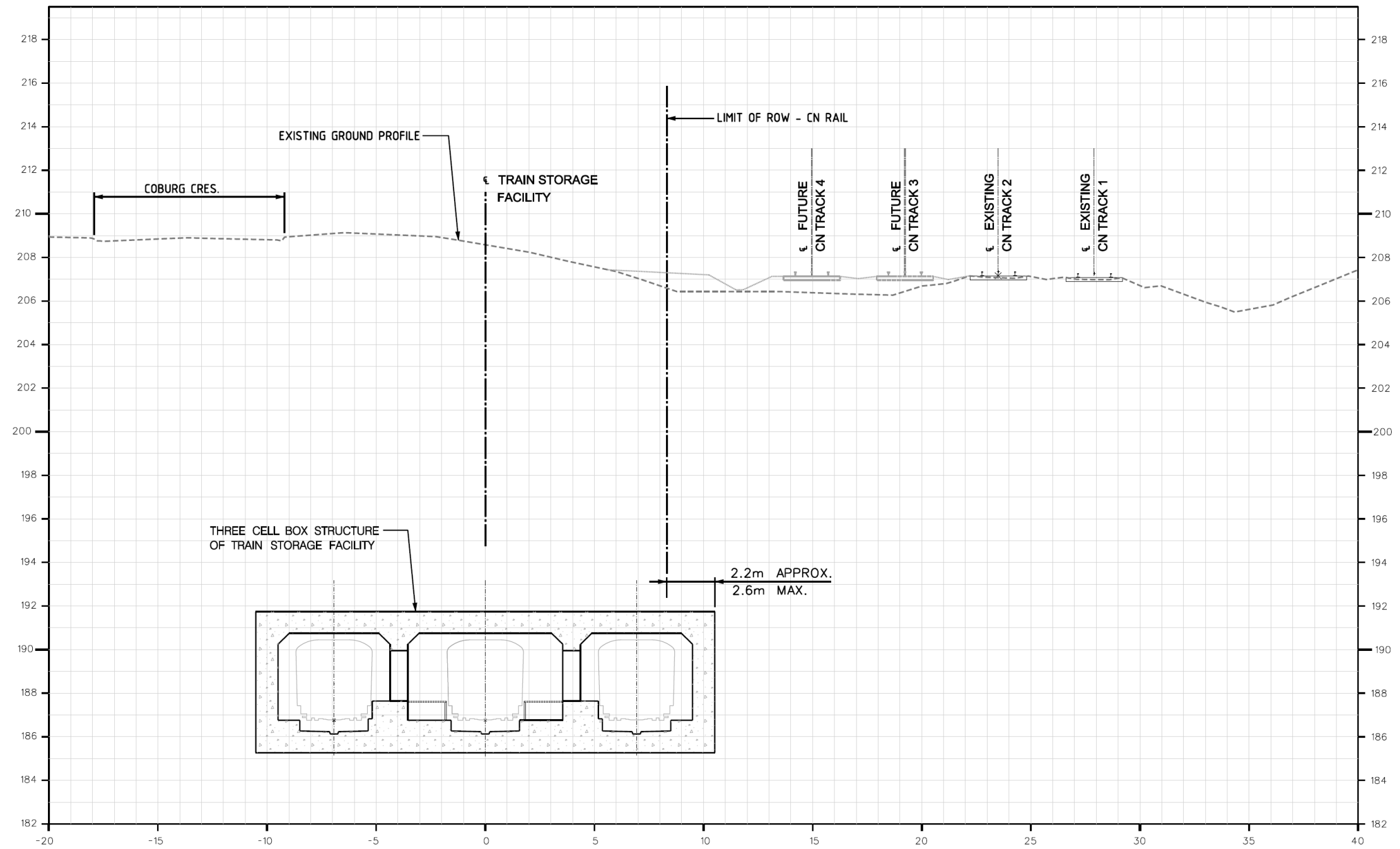
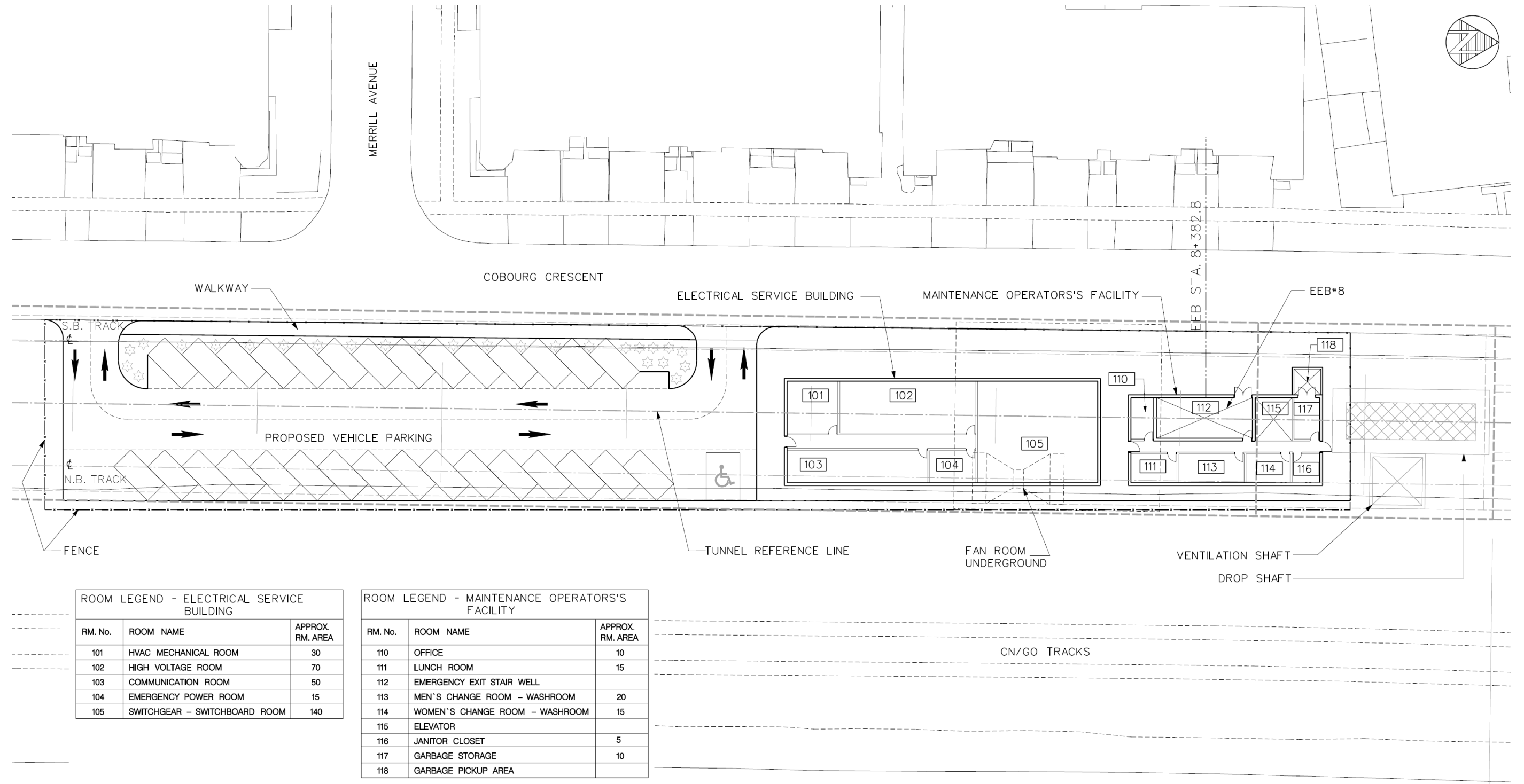

Figure 13-2: Proposed Train Storage Facility (Alignment Bi, Typical Cross Section)



SECTION
 TYPICAL SECTION - TRAIN STORAGE FACILITY SK041

Figure 13-3: Electrical Service Building & Maintenance Operator's Facility (Site Plan)



14. CONSTRUCTION PLAN

14.1 Purpose and Scope

The purpose of this section is to document the contracting strategy and construction methodology for the YSE that meets the challenging needs of this project and to develop an overall construction schedule for planning and costing purposes. The capital cost estimate is based on the methodology and assumptions described in this section. Detailed description of the proposed contracting strategy and construction methodology can be found in **Appendix 'H'** of this report. The proposed construction plan contained herein ensures that the project can be built within a reasonable timeframe – assuming a traditional Design-Bid-Build project delivery process. Other project delivery models would also be feasible with both positive and negative impacts to cost and schedule. A more detailed contracting strategy and construction schedule will be prepared during the next phase of design when more information with respect to timelines and funding becomes available.

14.2 Project Delivery Options

Numerous alternative methods of project delivery are available for consideration dependent on the degree of Owner control expected, sources of funding, criticality of schedule, degree of integration with the existing system, property acquisition requirements, maintenance and operational considerations and various risk issues. An in-depth evaluation of these alternatives is well beyond the scope of the Conceptual Design for the Yonge Subway Extension and will be listed as a basis for future consideration only. In addition, the fact that the line is an extension of the existing Yonge-Spadina Line with all major maintenance being undertaken at the TTC Wilson yard would suggest that the only viable options to consider would be conventional Design-Bid-Build, Design-Build and possibly Design-Build with Maintenance of the Station Facilities.

14.2.1 TRADITIONAL OR CONVENTIONAL PROCUREMENT – DESIGN-BID-BUILD

This strategy has been adopted for the Sheppard Line, the Toronto-York Spadina Subway Extension (TYSSE) and is being adopted for the Eglinton-Scarborough Crosstown Light Rail Transit (ESCLRT) project. Due to schedule criticality, these projects all relied upon Owner procurement of the earth pressure balance tunnel boring machines, the precast segmental tunnel lining for the bored tunnels and selected long delivery systems components. For these projects, engineering drawings and specifications are developed to 100% or 'construction-ready', tendered in the marketplace in the hope of receiving a very good price for undertaking the construction to the issued specifications and drawings.

In this model, it is the Owner who takes on the role of 'system-integrator' and is responsible for all of the internal and external engineering and operational interfaces of the project, or product that has been tendered. This model allows a high degree of Owner control and responsibility for the quality of output. Due to its widespread use for major transit projects in the Toronto area, this strategy has been used for the purpose of establishing a capital cost estimate and construction schedule as indicated in Appendix H.

14.2.2 DESIGN-BUILD (D-B)

In this delivery concept, the majority of the design effort is integrated with the construction effort by a contracted design-build organization, often but not always, a joint venture. The Owner generally develops the design to approximately 30% completion (it can be less). These designs are then tendered against by design-

build contractors who offer a firm price for completing all aspects of the work package; the winning consortium then acting as 'system-integrator' within the contract. Control of the major external interfaces usually remains with the Owner.

This recently tendered rail link from Union Station to Pearson Airport and the planned LRT expansion for Ottawa will use this model.

Design-Build may inject greater innovation into the design and construction process potentially resulting in greater cost certainty. The focus of design-build remains product delivery rather than service delivery and hence major long term risks including asset management remains with the Owner.

14.2.3 DESIGN, BUILD AND FINANCE (DBF)

A variation of design-build, this model requires the Construction JV to raise and fund the design and construction through its sources of private finance, usually a consortium of banks and equity lenders.

The use of private finance will act as a substantial incentive to the contractor to deliver the project on time and budget. The lender(s) will typically retain a technical advisor to identify any potential risks in the design-build program but this is not the same thing as Owner quality check.

A significant weakness of DBF is seen to be the lack of linkage to the longer term performance of the asset and its whole life cycle cost profile.

14.2.4 DESIGN, BUILD, FINANCE AND MAINTAIN (DBFM); DESIGN, BUILD, FINANCE, OPERATE AND MAINTAIN (DBFOM)

While the Finance element is important, the most important elements of these methods from the TTC's perspective are the Maintain and Operate parts. It is these that tie the contractor into a long term service delivery and life cycle asset management proposal, the basis of which is that they will be paid according to ongoing performance and not according to initial delivery.

The 'purest' of these schemes from a Public Private Partnership (PPP) perspective can rely on a limited specification and design input, typically 10% or less but will have a very clear statement of expected outputs and clear payment mechanisms linked to the delivery of the Key Performance Indicators (KPIs). The Canada Line Light Metro in Vancouver is considered to be a good example of a reasonably 'pure' performance specification-based PPP.

The Owner has a minimal role in the technical audit in DBF(OM) and is mainly auditing the performance output from the contract requirements. In these models, the lenders have a very strong technical due diligence role – although the due diligence is very much from the lender's risk perspective, not the Owner risk perspective.

The present configuration of the Yonge Subway Extension with the only heavy maintenance facility at Wilson Yard would not appear to be a suitable arrangement for the application of either of these models.

14.3 Construction Staging/Methodology

The basic premise behind the methodology developed for the Sheppard Line, the TYSSE, and proposed for this Yonge Subway Extension Project (YSE) is that where sufficient cover exists, tunnelling by earth pressure balance tunnel boring machines (TBMs), operating in pressurized mode at all times, represents the lowest cost construction methodology for the alignment, with the least surface disruption and consequently, should be maximized to the greatest extent possible. Where there is a need for larger open spaces (stations) or multiple track situations (crossover, pocket track and train storage facility), where tunnelling is not feasible, supported open cut excavation will be used. Tunnel drives indicated on drawings **SK023** and **SK024** represent 5082m of the overall alignment extension length of 7416m (69%). This includes 510m for stations that are initially tunnelled through and then subsequently constructed by cut and cover.

Various components of these methodologies are described below.

14.3.1 LAUNCH SHAFTS

Launch shafts are simply the locations where the tunnel boring machines are lowered to track level to commence a tunnel drive and subsequently used to remove spoil from the tunnel and to lower tunnel lining segments and other construction materials. The tunnelling contractor is generally responsible for the design and construction of the launch shaft, the slab that supports the TBM at the secant pile headwall and the thrust frame and TBM cradles. The excavation width for the length of the tunnel boring machine is slightly greater than the minimum width required for station and or twin box construction. The overall length of the TBM and trailing gear is 70-80m; however the launch shaft will be restricted to a length of 45m. In addition, the actual opening at street level will be further limited to 15m and located off-street where possible.

14.3.2 TUNNEL BORING MACHINES

The conceptual design for the tunnels consists of twin tunnels spaced at 13.59m centres with finished internal diameters of 5400mm. Generally, a cover equivalent to 1.5x tunnel diameter (8.1m) is maintained over the tunnels. As such, the proposed tunnel alignment has incorporated the following design requirements:

- The need to re-shape the existing stormwater pond (located in the northeast quadrant of Highway 407 and Yonge Street) prior to commencing the drive south from Richmond Hill Centre Station crossover to provide adequate cover
- The need for approach box structures on either side of the East Don River Bridge
- The need to introduce a vertical curve in the extension of the existing Finch Station tail track

It has been assumed that an owner-procured earth pressure balance (EPB) tunnel boring machine contract strategy will be adopted for YSE as it was for TYSSE and for Sheppard. These machines will be specified to operate in EPB mode which is defined as being operated with a filled, pressurized plenum chamber with tunnel spoil removal by means of a screw conveyor. An earth pressure balance tunnel boring machine (EPBM) is a fully shielded tunnel boring machine, which utilizes a full-diameter rotating cutter head equipped with a combination of drag teeth and disc cutters, and which advances using hydraulic rams that thrust against the tunnel initial support erected as a ring within the trailing shield. The machine operates with an active face support system equipped with a screw conveyor, ground conditioning system, and other equipment. The tunnel face support is provided by a highly viscous soil paste formed by the excavated materials mixed with conditioners (bentonite slurry, foams, polymers or other additives). To minimize ground

loss, the annulus between the precast tunnel lining and the cavity excavated by the TBM is grouted through radially spaced ports on the trailing shield.

14.3.3 TUNNEL DRIVES

Tunnel drives 1 and 2 (1,937m in length) will launch from LS₁ at the south end of the Richmond Hill Centre Station Crossover and mine south through the future Langstaff Station, terminating at extraction shaft ES₁ in the north approach box to the East Don River Bridge. Secant pile headwalls will be installed by the tunnel contractor at Langstaff. The tunnelling contractor will also be responsible for the temporary works required at both the launch and extraction shafts and potentially the permanent works at the launch shaft. Up to six weeks is typically allowed between the starts of the parallel drives. Upon completion of the drives, these particular TBMS would no longer be required.

Tunnel drives 3 and 4 (1,958m in length) will launch from LS₂ located adjacent and north of Steeles Station and mine north through the future Clark Station, terminating at extraction shaft ES₂ in the south approach box to the East Don River Bridge. Secant pile headwalls will be installed at Clark Station. Due to the high groundwater levels and groundwater pressures likely requiring cut-off walls to bedrock, Clark Station will be assigned to a station contractor. Upon completion of the drives, these TBMs will be transported back to Steeles Station for Drives 5 and 6.

Tunnel drives 5 and 6 (1,187m in length) will launch from LS₃ at the south end of the Steeles Station crossover and mine south through the future Cummer Station, terminating at extraction shaft ES₃ in the extension of the existing Finch tail track. Secant pile headwalls will be installed by the tunnel contractor at Cummer Station. Due to the fact that these drives will be the second in the series (following drives 3 and 4), it is proposed to also assign Cummer Station to this tunnelling contractor since the interface management will be more critical.

14.3.4 TUNNEL SEGMENTAL LINING

The bored tunnels are designed as a complete system. The tunnel lining internal diameter (5400mm), ring length (1500mm) and thickness (235mm) were specified for the TYSSE project as part of the TBM procurement work. Lining design was based on a standard universal six-segment ring (4 trapezoidal segments plus a key and counter-key segment). Geotechnical conditions for YSE would be very similar to those encountered on TYSSE and therefore any changes that would be considered for YSE would likely be as a result of actual experience on TYSSE. For this reason, it is expected that a similar procurement strategy for the tunnel lining would be adopted.

14.3.5 EXTRACTION SHAFTS

Extraction shafts are the locations where the tunnel boring machines are raised from track level to surface at the completion of a tunnel drive. Responsibility for the design and construction of the extraction shaft is assigned to the tunnelling contractor. The length of the extraction shaft will be 20m; however, where possible, it may be located off-street permitting the TBM to be slid from its final drive position to its removal position so that road traffic is not significantly affected. Alternatively, if the opening must be within the street ROW, the street will be decked over until such time as it becomes necessary to remove the machines. Since the

tunnelling drives are staggered by approximately six weeks, the removal of the TBMs will also be staggered by approximately six weeks.

14.3.6 CUT AND COVER CONSTRUCTION

Stations, crossovers and emergency exit facilities will be constructed by cut-and-cover methods. This practice was most recently used for the stations along Sheppard Avenue and will also be used for the TYSSE facilities. The majority of the Yonge Subway Extension stations and EEBs are located within the Yonge Street ROW. Cut-and-cover construction for these facilities will therefore require a series of measures to initially divert traffic and utilities to permit installation of the selected excavation support system.

Soldier piles and lagging excavation support is typically constructed by installing the soldier piles first within the pre-bored holes, followed by installing lagging boards concurrent with the excavation process. Limits are placed on the extent of open face area permitted to limit the potential for ground loss into the excavation. This option should be considered in conjunction with adequate surface water management. It should also be noted that soldier piles with lagging are a more flexible support system compared with secant piles or continuous concrete diaphragm walls. Soldier piles with lagging are typically considered suitable where ground movements are permitted to some degree, i.e. where sensitive structure or utilities are not located adjacent to the proposed excavation. An internal system of whaler beams and struts are provided to limit the deflection of the soldier piles. The spacing of the struts must also be placed in a manner that does not interfere with subsequent concrete placement. At surface, a system of deck beams will be installed to support the decking required to allow traffic movement during the excavation and construction process.

In place of horizontal supports or struts, soil anchors may be used to provide unrestricted access to the excavation areas. Soil anchors are generally designed by specialist contractors, who will supply, install and undertake appropriate tests to confirm that the soil anchors meet the temporary works design criteria. For anchors to be used, temporary construction easements will be necessary. Typically, anchors extend perpendicularly from the line of the excavation, or at a predetermined angle, beyond the line of the excavation a distance equal to 1.5 to 2.0 times the excavation depth. For this reason, soil anchors are used less frequently than the internal strut system.

The preliminary geotechnical reports for each station based on the current investigation programme provide guidance to when more specific water control measures are necessary to limit the risk of ground loss. These measures may include the installation of multi-stage eductors for dewatering of layered deposits and deep wells for depressurization of underlying aquifers. In the most severe circumstance, contiguous caisson or diaphragm walls installed from surface into the bedrock may be necessary.

To permit the installation of current and future utilities, the station structures and other structures such as ventilation shafts and emergency exits are generally positioned in such a manner to typically have 3m of cover from the road surface to the structure (crossovers would have considerably more cover). To minimize potential long term effects on the road systems, specifications mandate the quality and density of the backfill that is placed on the structure to ensure a satisfactory result. Around utilities and in areas where suitable compaction cannot be achieved, unshrinkable fill is specified.

14.4 Construction Sites

The project comprises a total of 5.08km of twin-bored tunnel, five stations, five substations, eight emergency exit buildings (EEBs), six dropshafts, six cross passages, one bridge, 513m of twin or triple box structure and an 831m below grade triple track train storage facility north of the Richmond Hill Centre Station. With the exception of the cross passages, all these facilities have a component of cut and cover construction with associated impact on current traffic flows and surrounding property.

Each of the contractors has requirements for site parking, site trailers and facilities, equipment storage, materials handling laydown and access. The tunnelling contractor has requirements for power distribution facilities, mechanical and electrical equipment, storage of lining segments and for the possible treatment of spoil that may not be in a state for immediate haulage from the site. The remaining contractors require additional storage space for formwork, reinforcing steel and other materials of construction including cranes. Significant truck movements are required to haul material offsite, deliver and pump concrete on-site and ultimately to bring backfill to the site prior to restoration.

The construction contracts for the scopes of work described herein will be structured to minimize, as much as possible, the interfaces between the adjacent contractors to avoid sources of conflict and resulting claims. In addition, it should be noted that there will also be system-wide contractors required for the installation of double ties and isolated slab, track, traction power and signalling and communications requirements that must be installed primarily at track level and whose work must also be coordinated particularly with the station contractors.

The four major areas of construction activity are described in more detail below:

14.4.1 RICHMOND HILL CENTRE STATION AND VICINITY

At least four large civil construction contracts are proposed for this 1.25km section of the Yonge Subway Extension (YSE). These include:

- At the south end of this area, a launch shaft will be required for the North Tunnels Contractor (Contractor 'A') to launch the TBMs for Drives 1 and 2 south towards the East Don River Bridge. Prior to commencing the excavation for the launch shaft, this contractor (or an early works contractor) must initially re-shape the existing stormwater pond so that sufficient cover exists to safely begin tunnelling. In addition, it is proposed that the Highway 7 Yonge Street ramp be re-aligned from its current location situated over the southern half of the crossover to the south of the proposed launch shaft. This re-alignment will limit the influence of on-ramp traffic on construction activity and avoid the need for numerous changes to the on ramp alignment that would otherwise be required. An extension to the stormwater pond inlet and the possible adoption of a siphon design will also be required to remove the interface conflict between the launch shaft and the inlet.
- The Richmond Hill Centre Station Contractor (Contractor 'B') will be responsible for construction of the station including entrances, electrical substation, crossover, and bus terminal. There is an option where the southernmost three units (45m) of the crossover structure could be assigned to the tunnelling contractor. Note that architectural drawing **SK-A-008** also indicates an underground Highway 407

Transitway Station to the south of the proposed bus terminal. Currently, that station does not form part of the YSE project and is not considered in this Conceptual Design evaluation.

- Approximately 415m of the below ground train storage facility will be assigned to Contractor 'C'. It should be noted that this contract would include 2.5 times the excavation quantity of a typical station box, 2.0 times the concrete quantity and 5.0 times the quantity of backfill.
- The remaining 419m of below ground train storage facility including two EEBs, a fan room, electrical services building, maintenance operators building and a possible drop shaft will be included in Contractor 'D' scope. In addition, construction of the train storage facility necessitates the removal and subsequent reconstruction of a significant portion of the existing Bantry Avenue Bridge.
- Drawing **SK020** was developed to show possible contractor site requirements and access. At this time, it would not appear to be possible to isolate construction traffic from traffic used by residents, office workers and mall patrons. It is expected however that a temporary satellite bus terminal facility will be developed such that the current VIVA bus terminal would not remain in operation during the construction programme.

14.4.2 EAST DON RIVER BRIDGE AND VICINITY

Existing Conditions

The East Don River is situated in a valley with wide open embankments on both sides and flows through a 14m span concrete arch culvert under Yonge Street. Yonge Street crosses the East Don River in the Thornhill Heritage District, with the Ladies' Golf Club of Toronto located on the east side of Yonge Street and the Thornhill Country Club located on the west side.

The existing Yonge Street roadway, supported on an embankment across the East Don River valley, consists of two general purpose lanes in each of the northbound and southbound directions and a centre left turn lane.

Traffic Management during Construction

The preliminary traffic staging concept involves a 4-lane traffic detour being built on the west side of Yonge Street adjacent to the bridge and bridge approaches and will follow the existing profile of Yonge Street. Care will be taken during construction to minimize environmental effects and to maintain continuous property access. Traffic stages indicated on drawings **SK036** and **SK037** consist of:

- Stage 1 includes a 4-lane traffic detour and a pedestrian walkway constructed on the west side of Yonge Street over the existing East Don River culvert.
- In Stage 2, the new bridge and east side approaches will be constructed. General traffic will circulate on the 4-lane detour built in Stage 1. Units for the west side approaches immediately adjacent to the bridge would also be constructed at this time to facilitate the next stage of traffic management.

- In Stage 3, the remaining west side approaches and ultimate Ladies Golf Club access will be constructed. Northbound traffic will use the new bridge; southbound traffic will continue to use the detour.

Construction Contracts

At least three large civil construction contracts are proposed for this 0.6km section of the Yonge Subway Extension (YSE). These include:

- At the north end of this section, a tunnel extraction shaft will be required for the North Tunnels contractor to retrieve the TBMs from Drives 1 and 2 launched from the south end of the Richmond Hill Centre Station crossover. This tunnelling contractor is responsible for dewatering and support of excavation for the tunnel extraction shaft and to retrieve the TBMs.
- At the south end of this section, a tunnel extraction shaft will be required for the South Tunnels contractor to retrieve the TBMs from Drives 3 and 4 launched from the north end of Steeles Station. This tunnelling contractor is responsible for dewatering and support of excavation for the tunnel extraction shaft and to retrieve the TBMs.
- The bridge contractor will be responsible for construction of the road detours, construction of the bridge and for both the north and south twin box approach structures including the permanent works at the extraction shafts. Once the tunnel drives are complete, drop shafts are proposed to be constructed within these extraction shaft locations.

14.4.3 STEELES STATION AND VICINITY

At least two large civil construction contracts are proposed for this 395m section of the Yonge Subway Extension (YSE). These include:

- At the north end of this section, a tunnel launch shaft will be required for the South Tunnels contractor to launch the TBMs for Drives 3 and 4 north towards the East Don River Bridge.
- At the south end of the Steeles Station crossover, a tunnel launch shaft will be required for the South Tunnels contractor to launch the TBMs for Drives 5 and 6 southwards to extraction shaft ES₃ located in the extension of the Finch Station tailtrack.
- The above tunnelling drives including dewatering and support of excavation for the launch shafts are assigned to the same contractor. This contractor is also assigned the construction of Cummer Station, the electrical substation at Cummer and the 180m extension of the Finch tailtrack structure.
- The Steeles Station Contractor will be responsible for construction of the subway station including entrances, electrical substation, and crossover. There is an option where the southernmost three units (45m) of the crossover structure and the 45m of box structure on the north side of Steeles Station could be assigned to the South Tunnels Contractor.

- The excavation will be decked over, where possible, to facilitate traffic flow and property access. Due to limited depth of cover, decking may be removed to permit construction of the Station roof slab.
- The Steeles Station Contractor's work will also include the construction of a 16-bay below ground bus terminal with a 185m long bus platform and associated ramps and entrance portals with an overall portal to portal distance of 660m beneath Steeles Avenue.
- Drawings **SK021** and **SK031-SK033** were developed to show possible contractor site requirements and access.

All elements of a traffic management concept must be approved by the affected road authorities, in consultation with the Police, the Fire Department, and Emergency Medical Services, prior to award of a construction contract.

Prior to the start of construction, the Proponent will organize information sessions, as required, with the local community and business groups to explain the construction activities and restrictions, as well as to establish lines of communication.

Construction and proposed staging procedures will have temporary and/or permanent effects. For each construction site, a specific construction and staging plan will be developed during detailed design and will be implemented during construction based on traffic management principles that have been proven successful on other similar subway construction projects including the Sheppard Line.

The general guidelines and principles that will be followed for traffic management during construction of the Yonge Subway extension (YSE) include but are not limited to the following:

14.4.4 CUMMER STATION AND VICINITY

One large civil construction contract is proposed for this 520m section of the Yonge Subway Extension (YSE) to minimize the potential number of contract interfaces and risk of claims. As noted in Section 2.3, it is proposed to assign this work to the South Tunnelling Contractor responsible for tunnel drives 3 and 4 from Steeles Station north to the East Don River extraction shaft ES₂ and for tunnel drives 5 and 6 from the south end of the Steeles Station crossover to extraction shaft ES₃. The work at Cummer Station and vicinity will include:

- A 180m triple box extension of the existing Finch pocket track;
- At the north end of this triple box section, a tunnel extraction shaft (ES₃) will be required for the tunnelling contractor to retrieve the TBMs from Drives 5 and 6. The contractor is responsible for dewatering and support of excavation for the tunnel extraction shaft and to retrieve the TBMs.
- Installation of the secant pile headwalls at Cummer Station so that the TBMs can tunnel through the station;
- Tunnel drives 5 and 6 will include for 174m through Cummer Station and 166m between Cummer Station and the extraction shaft ES₃;
- Construction of Cummer Station including entrances and an electrical substation.
- Drawing **SK025** was developed to show possible contractor site requirements and access.

14.5.1 TRAFFIC LANES

Where possible, the existing number of lanes will be preserved at an individual construction site. When this cannot be achieved, maintaining current or improvements to transit operations should be the first priority.

As a general guideline, where the road surface must be excavated, the minimum number of lanes of traffic, as noted in **Table 12-1**, should be provided at all times.

14.5 Traffic Management

The Traffic Management Plan will detail vehicular and pedestrian traffic arrangements during the construction of the Project. The analysis of traffic operations in the Traffic Management Plan will generally follow the Traffic Impact Study Guidelines prepared by the City of Toronto and York Region. The complexity of the Traffic Management Plan will also be related to the extent of the construction contract and the nature of the existing traffic congestion issues in the construction zone. The Traffic Management Plan will be developed during detailed design.

Table 14-1: Minimum Number of Lanes to be Maintained

Existing Lanes	Minimum Number of Lanes to be Maintained
1 lane in each direction	1 lane with appropriate controls
2 lanes in each direction	1 lane in each direction
2 lanes in each direction 1 centre left turn (continuous)	1 lane in each direction 1 left turn at signalized intersection
3 lanes in each direction	2 lanes in peak direction 1 lane in off peak direction
3 lanes in each direction 1 centre left turn lane (continuous)	2 lanes in peak direction 1 lane in off peak direction 1 left turn signalized intersection

14.5.2 ALTERNATIVE TRAFFIC OPTIONS

Where partial lane closures must occur, traffic operations in the area of the construction, including appropriate upstream and downstream intersections, will be analysed to assess queue lengths, delays and general levels of service.

14.5.3 ROAD CLOSURES

Where full closure of the road must occur, a suitable road detour will be designated, with the approval of the appropriate road authorities. Temporary closings of arterial roads may occur during designated time periods acceptable to the approval authority. In major commercial areas i.e. Centrepoint Mall, later start times for road closures may be considered for detailed design.

14.5.4 TURN LANES

Where lane closures are required at signalized intersections and a left turn lane is presently provided, provision for left turning vehicles will be provided. If not possible due to construction, approval for the left turn restriction must be given by the appropriate road authority. If a left turn restriction is allowed, then a suitable detour route for left turns will be designated.

Right turn lanes may be closed and need not be accommodated in the traffic diversion, unless traffic volumes dictate their permanent need. This will be coordinated with or dictated by the road authority.

14.5.5 SIGNING

For all areas of construction, suitable advance signing will be provided. Where lane restrictions will be present for long periods of time, advance signing will also include appropriate alternate routes to encourage motorists to avoid the construction area.

14.5.6 TRAFFIC SIGNAL ADJUSTMENTS/TIMING

Where elements of the traffic signal infrastructure must be adjusted to accommodate traffic diversions or excavations, the physical relocation will be designed for submittal to the appropriate road authority.

Where lane closures at a traffic signal must occur, there may be a need to adjust the traffic signal timing.

14.5.7 TRANSIT OPERATIONS AND HOV LANES

Maintenance of transit operations are deemed to be the highest priority during any restrictions imposed by construction. Where possible, a dedicated bus lane should be provided. Requirements during construction will be coordinated with the transit operator.

HOV lanes will not be provided during construction.

14.5.8 PEDESTRIANS

A minimum 1.2m pedestrian sidewalk will be provided if a sidewalk currently exists. Where a sidewalk must be closed for temporary construction work, alternative pedestrian routes with appropriate signage will be provided.

14.5.9 PRIVATE ACCESS

Access will be maintained to all driveways throughout the construction period, unless suitable arrangements have been made with the property owner and the appropriate road authority to provide an alternative access or temporary closure.

14.6 Construction Schedule

Section 14.2 Contracting Options provides a list of basic contracting options that were considered for the implementation of the Yonge Subway Extension (YSE). At this time, no overall project constraint dates have been established or identified.

As noted in Section 14.2.1, this project adopts one potential set of proposed contracts to be applied for the Yonge Subway Extension (YSE) so that an overall construction schedule can be established and approximate durations assigned to various construction activities. Where possible, the objective is to minimize the potential for claims by limiting the overall number of contracts and associated contract interfaces.

Figures 14-1 and 14-2 provide an overview of the key components needed for the YSE including proposed locations for launch shafts, extraction shafts and direction of tunnel drives.

As noted, the capital cost estimate includes four new TBMs. The assumption is that two tunnelling contracts will be awarded. The first contract including for tunnel drives No 1 and 2 from a launch shaft situated at the south end of the Richmond Hill Centre crossover to extraction shaft (ES₁) at the north end of the north approach structure for the East Don River Bridge. The second contract would include for tunnel drives 3 and 4 from the launch shaft located adjacent to and north of the Steeles Station to extraction shaft (ES₂) at the south end of the south approach structure to the East Don River Bridge. The second contract would also include tunnel drives 5 and 6 from the launch shaft located at the south end of the Steeles Station crossover to extraction shaft (ES₃) at the north end of the extension of the Finch tail track.

Tunnels will be initially driven through Langstaff, Clark and Cummer Stations. The construction of Langstaff Station was assumed to be added to the north tunnel contract. The construction of Cummer Station could be added to the south tunnel contract. The construction of Richmond Hill Centre Station and crossover, Clark Station and Steeles Station and crossover would be separate contracts.

14.7 Critical Path

A preliminary design and a preliminary construction schedule have been prepared (see **Attachments 1 and 2**) that documents the adoption of the proposed strategy for contract packaging. It should be noted that this schedule has been greatly simplified to establish approximate total construction duration for the project. The simplification that has been applied is that all systems installation can occur within the timeframe assigned to

structural and finishing for the stations. The critical path resulting from the above includes for the following general activities:

- RFP and award of the Geotechnical Investigation;
- RFP and award for the Design of Cummer Station;
- Design of Cummer Station;
- Tender and award for construction of the South Tunnels and Cummer Station;
- Construction of the South Tunnels, Cummer Station and Finch tail track extension including:
 - Construction of Launch Shaft LS₂;
 - Set-up and tunnel drives from LS₂ to extraction shaft ES₂ located within the south approach structure at the East Don River Bridge;
 - Set-up and tunnel drives from LS₃ to extraction shaft ES₃ located within the extension of the existing Finch Station tail track;
 - Complete excavation, construct structure and finishing for Cummer Station;
- Installation of systems work, and
- Commissioning of the system and tie-in to the existing Yonge Subway.

Figure 14-1: Proposed Tunnelling General Arrangement (Finch Station to North of the East Don River Bridge)



Figure 14-2: Proposed Tunnelling General Arrangement (North of the East Don River Bridge to RHC Station)

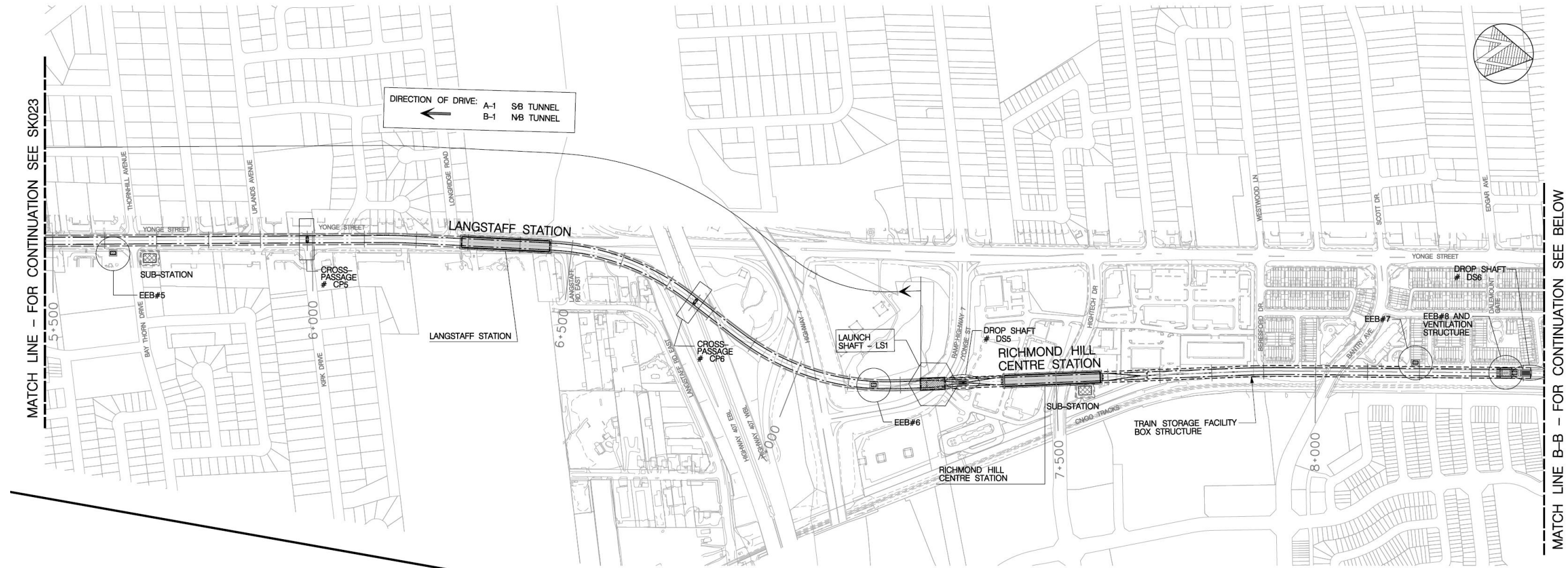

NOTE:
 FOR LEGEND AND TUNNEL DRIVE SEQUENCE SEE SKETCH SK023.

15. PROPERTY REQUIREMENTS

Permanent property acquisition for the project is primarily focused at the stations to accommodate entrance buildings, ventilation shafts, electrical substations, and other station related infrastructure. Permanent property is also required at the Emergency Exit Buildings which are not located near stations. Temporary property will also be required at the Yonge/Steeles intersection for construction staging areas.

The extent of property acquisition at the Richmond Hill Centre Station has yet to be finalized as the final arrangement of the subway station – including the bus terminal and passenger connections – will be the subject of further investigation with all key stakeholders in the area.

A current list of permanent property requirements can be found in **Appendix 'I'** of this report.

- **Cummer Station** – it is anticipated that a total of 7 properties will be required to accommodate station entrance buildings, ventilation shafts, and bus loop for the station
- **Steeles Station** – It is anticipated that a total of 46 partial or full takings of residential and commercial properties will be required in order to widen Steeles Avenue based on the preferred plan. Along the south side of Steeles Avenue, immediately east of Yonge Street and extending to Willowdale Avenue, a row of approximately 28 residential properties will need to be acquired.
- **Clark Station** – It is anticipated that a total of 4 properties will be required to accommodate station entrance buildings and vent shafts for the station.
- **Between Clark Station and Langstaff Station** – It is anticipated that a total of two or three properties will be required to accommodate a substation at the intersection of Yonge Street and Thornhill Avenue/Bay Thorn Drive. As there are two possible sites for the substation at this location, both sites have been identified.
- **Langstaff Station** – It is anticipated that a total of 2 properties will be required to accommodate station entrance buildings, ventilation shaft, commuter park-and-ride lot, and passenger pick-up/drop-off facility for the station.
- **Running Structure** – It is anticipated that subsurface easements will be required to accommodate the subway's twin tunnels.
- **Emergency Exit Buildings** – It is anticipated that a total of six or seven properties will be required to accommodate emergency exit buildings between stations. As there are two possible sites for EEB5, both sites have been identified.

16. CAPITAL COST ESTIMATE

Once the scope of the project had been defined, both TTC and Hanscomb were given the Conceptual Design drawings for the project and were asked to prepare Capital Cost Estimates for the project. The TTC's estimating template was used for both estimates to facilitate comparisons between the estimates and clearly identify where any cost differences were.

The estimates were prepared using different approaches. The TTC applied estimated unit rates for the major elements, whereas Hanscomb attempted to estimate the quantities for the project elements and apply estimated construction unit rates. For the track and system elements of the project, Hanscomb deferred to the TTC's unit rates as they did not have access to comparable unit rates. Allowances have been added to the estimate to cover engineering, contingency, property, vehicles and HST rebate. Estimates were prepared based on 2011 costs with no allowance for future escalation to the year of expenditure.

After both estimates were completed, several meetings were held within the project team to discuss the two estimates and attempt to reconcile any obvious differences in cost. Upon completion of this exercise, the capital cost estimate for the Yonge Subway Extension is estimated between \$3.12 billion and \$3.35 billion. A summary table of the estimates are included below.

After attempting to reconcile the two estimates, the major areas of difference between the TTC's estimate and Hanscomb's estimate were stations and the application of taxes. Prior to the application of taxes, Hanscomb's estimate for the five stations is \$814.0 million while the TTC's estimate is \$772.5 million, for a difference of \$41.5 million or 5.3%. After all of the capital costs have been estimated, the applicable tax implications were then added to both estimates. In the TTC estimate, the additional taxes were \$58.2 million while Hanscomb's estimate of additional taxes was \$160.6 million, for a difference of \$102.4 million. These two differences were then escalated for engineering, contingency and property for a net difference of \$226 million between the two estimates, which represents a range of 7.2%.

In looking at the bottom line, the TTC and Hanscomb estimates are close to one another – which should afford a high level of confidence that the project can be built within this envelope. On other projects of this magnitude, variance between estimators is rarely this close and the variances usually set in motion long and protracted reconciliation processes. Differences exist between estimates in individual line items, but they are not material at this stage of project development.

Table 16-1: YSE Conceptual Design Capital Cost Estimate (Summary)

No.	Item Description	Quantity	Unit	TTC Estimate		Hanscomb Estimate	
				Unit Cost \$M	2011 \$M	Unit Cost \$M	2011 \$M
1	Stations & Area Facilities	5	ea	\$159.4	\$797	\$182.6	\$913
2	Running Structures & Special Structures	7.39	km	\$107.4	\$794	\$111.1	\$821
3	Utilities	7.39	Km	\$6.0	\$44	\$6.4	\$47
4	Operating Systems	7.39	Km	\$30.2	\$223	\$30.2	\$223
	Subtotal				\$1,858		\$2,004
5	Engineering & Management				\$465		\$501
6	Contingency				\$697		\$752
7	Property/Easement				\$164		\$177
8	Revenue Vehicles	12	Trains		\$221		\$221
9	HST Rebate	1	LS		(\$287)		(\$309)
Total Estimated Cost in 2011 \$M					\$3,120		\$3,346

17. FUTURE WORK AND NEXT STEPS

Upon completion of the Conceptual Design Study, several issues will need to be addressed to keep the project moving forward. These include:

- Complete a TPAP for the extension of the project to include the underground train storage facility in the area of Richmond Hill Centre Station;
- Continue work with the Town of Richmond Hill, Town of Markham, 407 ETR, Metrolinx, other stakeholders and area land owners on the design and integration of a bus terminal with area development to connect the rapid transit infrastructure located within the Richmond Hill Centre Station and the Richmond Hill Centre / Langstaff Mobility Hub;
- Undertake a property protection study to address any property required for the YSE that is not already protected under the approved TPAP; and
- Undertake the development of a preliminary engineering work program for the YSE

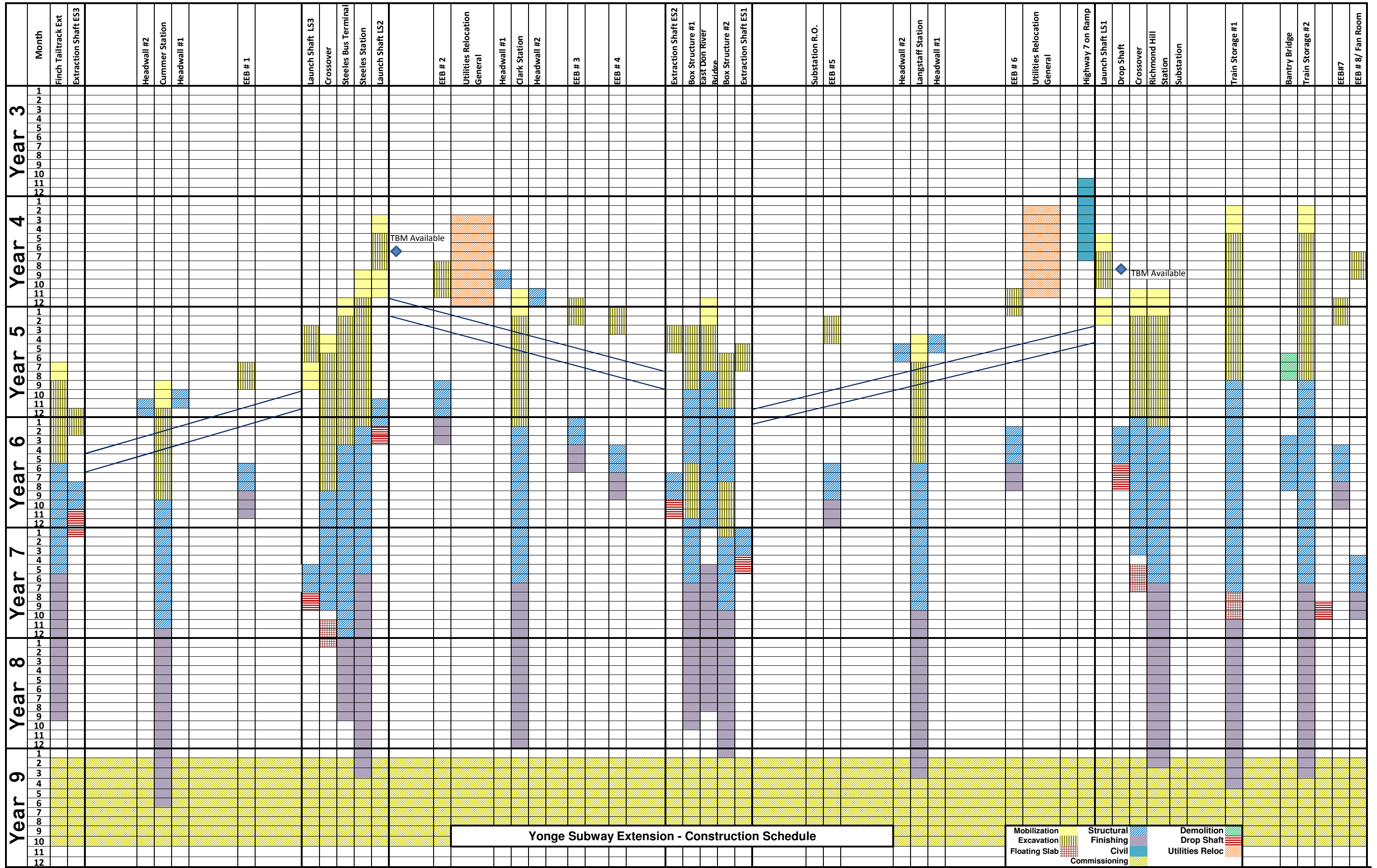

Activity ID	Activity Name	Original	Start	Finish	Year									
					1	2	3	4	5	6	7	8	9	10
Design and Procurement														
Geotechnical Investigations														
A0010	Project Start	0	01-Mar-12*		◆ 01-Mar-12*									
A1000	RFP and Award	86	01-Mar-12	29-Jun-12	■ RFP and Award									
A1010	Geotechnical Work Plan	40	02-Jul-12	27-Aug-12	■ Geotechnical Work Plan									
A1020	Geotechnical Investigations (2 or 3 Stages)	240	28-Aug-12	07-Aug-13	■ Geotechnical Investigations (2 or 3 Stages)									
A1030	Geotechnical Design Reports	260	26-Feb-13	05-Mar-14	■ Geotechnical Design Reports									
A1040	Geotechnical Baseline Report(s) Tunnels	186	05-Sep-13	29-May-14	■ Geotechnical Baseline Report(s) Tunnels									
A1050	Geotechnical Baseline Report(s) Stations	191	02-Dec-13	29-Aug-14	■ Geotechnical Baseline Report(s) Stations									
Tunnel Design														
A1060	Design RFP Award	80	02-Jul-12	23-Oct-12	■ Design RFP Award									
A1070	Tunnel Pkg A Design	490	24-Oct-12	29-Sep-14	■ Tunnel Pkg A Design									
A1080	Tender and Award Tunnel Pkg A	100	30-Sep-14	20-Feb-15	■ Tender and Award Tunnel Pkg A									
A1470	Tunnel Pkg B Design	490	21-Dec-12	24-Nov-14	■ Tunnel Pkg B Design									
A1480	Tender and Award Tunnel Pkg B	100	25-Nov-14	17-Apr-15	■ Tender and Award Tunnel Pkg B									
Tunnel Boring Machine														
A1100	Prepare Spec	110	22-Jan-13	25-Jun-13	■ Prepare Spec									
A1110	Tender and Award	120	26-Jun-13	16-Dec-13	■ Tender and Award									
A1120	Manufacture (TBM's A and B)	400	17-Dec-13	14-Jul-15	■ Manufacture (TBM's A and B)									
A1125	Manufacture (TBM's C and D)	400	13-Feb-14	09-Sep-15	■ Manufacture (TBM's C and D)									
Tunnel Segments														
A1130	Segment Design	120	16-Apr-13	03-Oct-13	■ Segment Design									
A1140	Tender and Award	90	04-Oct-13	12-Feb-14	■ Tender and Award									
A1145	Plant Mobilization	100	13-Feb-14	03-Jul-14	■ Plant Mobilization									
A1150	Manufacture	440	07-Jul-14	29-Mar-16	■ Manufacture									
Station Design														
A1160	RFP and Award	90	04-Jun-12	09-Oct-12	■ RFP and Award									
A1170	Work Plan	40	10-Oct-12	06-Dec-12	■ Work Plan									
Cummer														
A1180	Design to 30%	120	07-Dec-12	28-May-13	■ Design to 30%									
A1190	Design to 60%	120	29-May-13	14-Nov-13	■ Design to 60%									
A1200	Design to 90%	124	15-Nov-13	13-May-14	■ Design to 90%									
A1210	Design to 100%	100	14-May-14	03-Oct-14	■ Design to 100%									
A1220	Tender and Award	100	06-Oct-14	26-Feb-15	■ Tender and Award									
Clark														
A1300	Design to 30%	130	08-Jan-13	10-Jul-13	■ Design to 30%									
A1310	Design to 60%	130	11-Jul-13	15-Jan-14	■ Design to 60%									
A1320	Design to 90%	134	16-Jan-14	24-Jul-14	■ Design to 90%									
A1330	Design to 100%	110	25-Jul-14	31-Dec-14	■ Design to 100%									
A1335	Tender and Award	100	02-Jan-15	21-May-15	■ Tender and Award									
Langstaff														
A1340	Design to 30%	130	07-Dec-12	11-Jun-13	■ Design to 30%									
A1350	Design to 60%	130	12-Jun-13	16-Dec-13	■ Design to 60%									
A1360	Design to 90%	130	17-Dec-13	19-Jun-14	■ Design to 90%									
A1370	Design to 100%	110	20-Jun-14	24-Nov-14	■ Design to 100%									
A1375	Tender and Award	100	25-Nov-14	17-Apr-15	■ Tender and Award									
Steeles														
A1380	Design to 30%	150	08-Jan-13	07-Aug-13	■ Design to 30%									
A1390	Design to 60%	147	08-Aug-13	07-Mar-14	■ Design to 60%									
A1400	Design to 90%	150	10-Mar-14	08-Oct-14	■ Design to 90%									
A1410	Design to 100%	120	09-Oct-14	31-Mar-15	■ Design to 100%									
A1460	Tender and Award	100	01-Apr-15	20-Aug-15	■ Tender and Award									

▶ Summary
◆ Milestone
◆ Critical Milestone
 Remaining Work
 Critical Remaining Work

Yonge Subway Extension Project Schedule

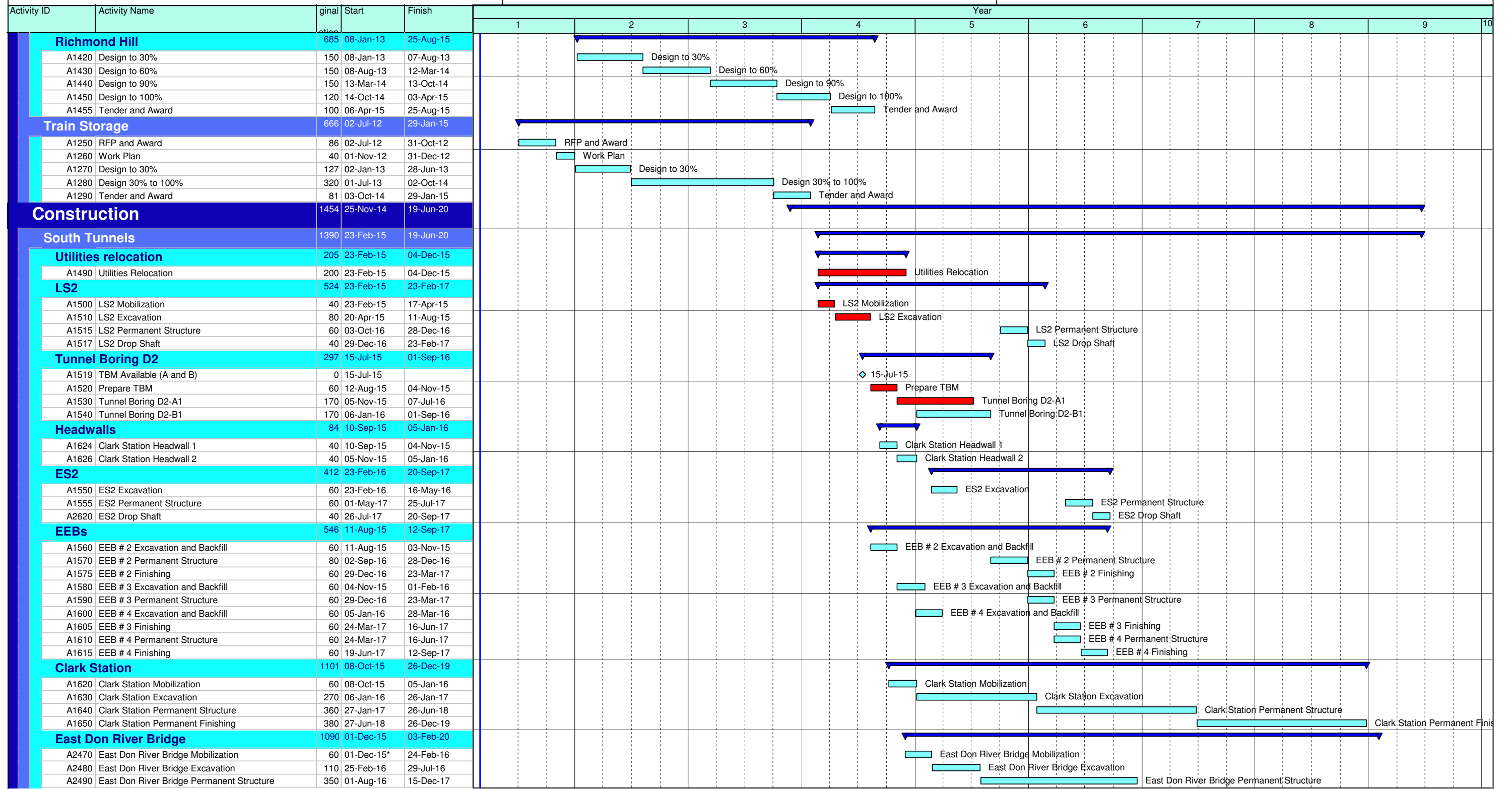

Summary
 Actual Work
 Milestone
 Critical Milestone
 Remaining Work
 Critical Remaining Work

2 of 5
Yonge Subway Extension
Project Schedule

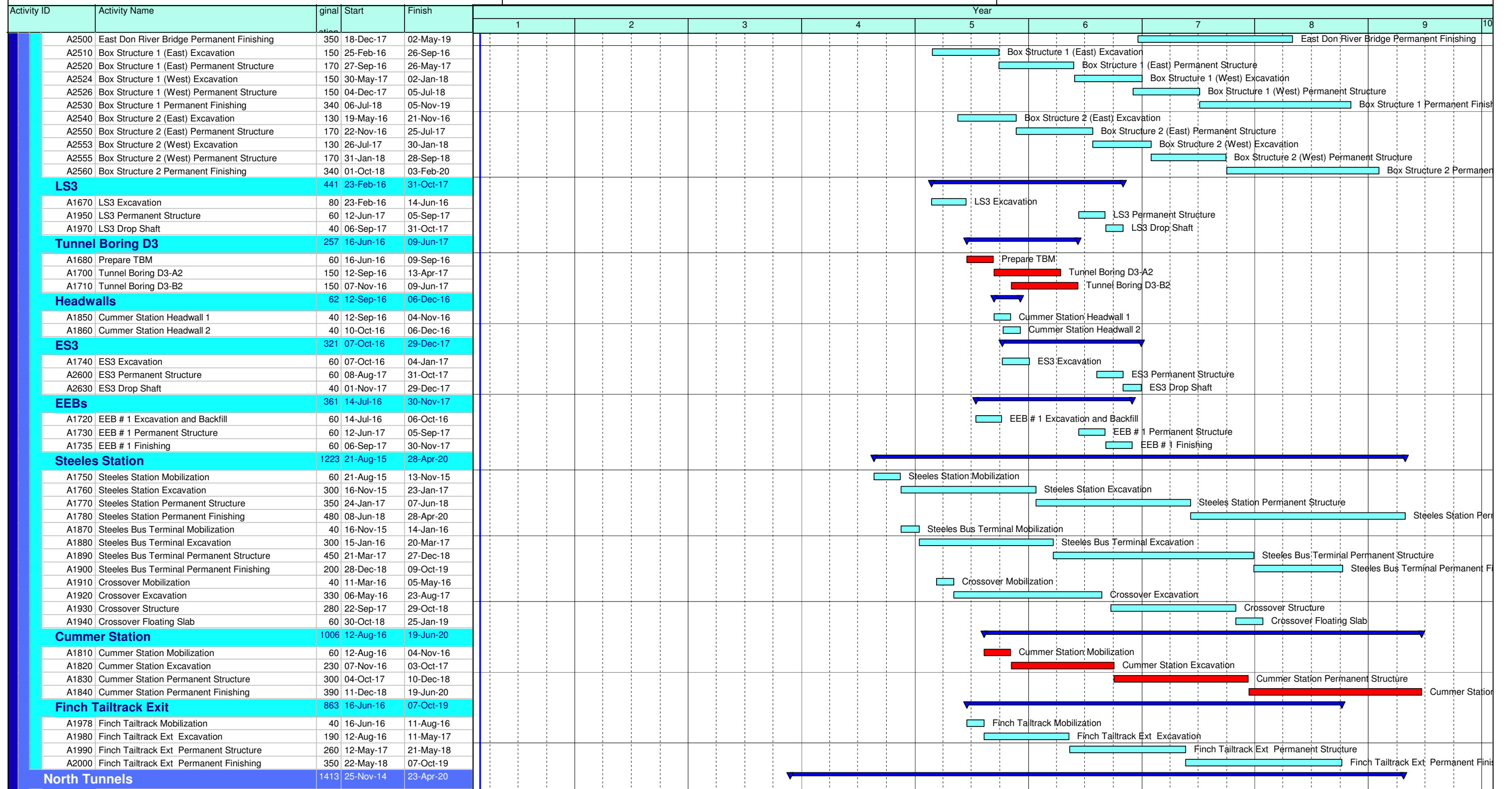

▶ Summary █ Actual Work
◇ Milestone ◇ Critical Milestone
 Remaining Work Critical Remaining Work

Activity ID	Activity Name	Original	Start	Finish	Year									
					1	2	3	4	5	6	7	8	9	10
Utilities Relocation														
A2005	Highway 7 on Ramp Civil Works	190	25-Nov-14	25-Aug-15	Highway 7 on Ramp Civil Works									
A2010	Utilities Relocation	220	26-Jan-15	04-Dec-15	Utilities Relocation									
LS1														
A2020	Mobilization	40	04-May-15	29-Jun-15	Mobilization									
A2030	Excavation	80	30-Jun-15	21-Oct-15	Excavation									
A2200	Launch Shaft Structure	80	13-Jan-17	04-May-17	Launch Shaft Structure									
A2210	Drop Shaft	60	05-May-17	31-Jul-17	Drop Shaft									
Tunnel Boring D1														
A2039	TBM Available (C and D)	0	10-Sep-15		10-Sep-15									
A2040	Prepare TBM	60	19-Nov-15	16-Feb-16	Prepare TBM									
A2050	Tunnel Boring D1-C1	190	17-Feb-16	11-Nov-16	Tunnel Boring D1-C1									
A2060	Tunnel Boring D1-D1	190	13-Apr-16	12-Jan-17	Tunnel Boring D1-D1									
Headwalls														
A2180	Langstaff Station Headwall 1	40	16-Mar-16	10-May-16	Langstaff Station Headwall 1									
A2190	Langstaff Station Headwall 2	40	13-Apr-16	08-Jun-16	Langstaff Station Headwall 2									
ES1														
A2070	Excavation	60	13-Apr-16	07-Jul-16	Excavation									
A2640	Permanent Structure	60	27-Jun-17	20-Sep-17	Permanent Structure									
A2650	Drop Shaft	40	21-Sep-17	15-Nov-17	Drop Shaft									
EEBs														
A2080	EEB # 6 Excavation and Backfill	60	22-Oct-15	19-Jan-16	EEB # 6 Excavation and Backfill									
A2090	EEB # 6 Permanent Structure	80	13-Jan-17	04-May-17	EEB # 6 Permanent Structure									
A2095	EEB # 6 Finishing	60	05-May-17	31-Jul-17	EEB # 6 Finishing									
A2100	EEB # 5 Excavation and Backfill	60	20-Jan-16	12-Apr-16	EEB # 5 Excavation and Backfill									
A2110	EEB # 5 Permanent Structure	80	05-May-17	28-Aug-17	EEB # 5 Permanent Structure									
A2115	EEB # 5 Finishing	60	29-Aug-17	21-Nov-17	EEB # 5 Finishing									
Langstaff Station														
A2140	Langstaff Station Mobilization	60	16-Mar-16	08-Jun-16	Langstaff Station Mobilization									
A2150	Langstaff Station Excavation	240	09-Jun-16	18-May-17	Langstaff Station Excavation									
A2160	Langstaff Station Permanent Structure	350	19-May-17	04-Oct-18	Langstaff Station Permanent Structure									
A2170	Langstaff Station Permanent Finishing	375	05-Oct-18	27-Mar-20	Langstaff Station Permanent Finishing									
Richmond Hill Station														
A2220	Richmond Hill Station Mobilization	60	22-Oct-15	19-Jan-16	Richmond Hill Station Mobilization									
A2230	Richmond Hill Excavation	260	20-Jan-16	26-Jan-17	Richmond Hill Excavation									
A2240	Richmond Hill Permanent Structure	360	27-Jan-17	26-Jun-18	Richmond Hill Permanent Structure									
A2250	Richmond Hill Permanent Finishing	420	27-Jun-18	21-Feb-20	Richmond Hill Permanent Finishing									
A2260	Crossover Mobilization	60	22-Oct-15	19-Jan-16	Crossover Mobilization									
A2270	Crossover Excavation	240	20-Jan-16	28-Dec-16	Crossover Excavation									
A2280	Crossover Structure	330	29-Dec-16	16-Apr-18	Crossover Structure									
A2290	Crossover Floating Slab	60	15-May-18	08-Aug-18	Crossover Floating Slab									
Train Storage														
A2300	Train Storage #1 Mobilization	60	30-Jan-15	23-Apr-15	Train Storage #1 Mobilization									
A2310	Train Storage #1 Excavation	350	24-Apr-15	08-Sep-16	Train Storage #1 Excavation									
A2320	Train Storage #1 Permanent Structure	480	09-Sep-16	31-Jul-18	Train Storage #1 Permanent Structure									
A2330	Train Storage #1 Floating Slab	60	01-Aug-18	24-Oct-18	Train Storage #1 Floating Slab									
A2340	Train Storage #1 Permanent Finishing	380	25-Oct-18	23-Apr-20	Train Storage #1 Permanent Finishing									
A2370	Train Storage #2 Mobilization	60	30-Jan-15	23-Apr-15	Train Storage #2 Mobilization									
A2380	Train Storage #2 Excavation	350	24-Apr-15	08-Sep-16	Train Storage #2 Excavation									
A2390	Train Storage #2 Permanent Structure	460	09-Sep-16	02-Jul-18	Train Storage #2 Permanent Structure									
A2410	Train Storage #2 Permanent Finishing	440	03-Jul-18	26-Mar-20	Train Storage #2 Permanent Finishing									
A2420	EEB # 8 Excavation and Backfill	60	22-Jun-15	15-Sep-15	EEB # 8 Excavation and Backfill									
A2430	EEB # 8 Permanent Structure	80	09-Apr-18	31-Jul-18	EEB # 8 Permanent Structure									
A2435	EEB # 8 Finishing	60	01-Aug-18	24-Oct-18	EEB # 8 Finishing									

▶ Summary █ Actual Work
◆ Milestone ◆ Critical Milestone
█ Remaining Work █ Critical Remaining Work

Yonge Subway Extension Project Schedule

Activity ID	Activity Name	Original	Start	Finish	Year															
					1	2	3	4	5	6	7	8	9	10						
A2440	EEB # 7 Excavation and Backfill	60	11-Nov-15	08-Feb-16																
A2450	EEB # 7 Permanent Structure	60	27-Apr-17	21-Jul-17																
A2455	EEB # 7 Finishing	60	24-Jul-17	16-Oct-17																
Bantry Bridge																				
A2350	Bantry Bridge Demolition	60	15-Jun-16	08-Sep-16																
A2360	Bantry Bridge Permanent Structure	130	02-Mar-17	01-Sep-17																
Commissioning																				
A2590	Commissioning	194	03-Feb-20	29-Oct-20																

Summary
 Milestone
 Critical Milestone
 Remaining Work
 Critical Remaining Work
 Actual Work

Yonge Subway Extension
Project Schedule

Item	Section	Reviewer	Dwg. # / Spec Section / Page #	Comment	Response	Action
1	ENG-CIVIL	fgeorgis-1	General	Ensure that future stormwater management determines the major storm events and ensure that major drainage remains clear of all possible entrance points where stormwater can enter the subway system. All entrance points should be at least 1 meter above major storm water levels.	Noted	
2	ENG-STR	ppetrovi-1	3277670 Conceptual Design Report Working Draft v4	Consider stations without wall finishes, similar to Sheppard line. This would enable easy monitoring and maintenance of the structures, including hardly avoidable leakages. This was expressed by Plant Maintenance before.	Noted	
3	ENG-STR	ppetrovi-2	3277670 Conceptual Design Report Working Draft v4	3.2.3 indicates that the platforms will be designed to accommodate future installation of PED's and at the same time indicates that reduced platform widths would be possible (second last sentence of the first paragraph). Still, 3.3.11 shows conceptual design with full width of the platform, without reduction.	Platform widths to be finalized during subsequent design studies	
4	ENG-STR	ppetrovi-3	3277670 Conceptual Design Report Working Draft v4	3.2 - Has anyone considered for some (or all) stations the possibility of eliminating the separate platform level by widening the concourse level and combining it with platform level? Depth of piles for SOE would be significantly reduced, there would be less stairs, escalators and elevators and the structures would be simpler and less costly. There would be probably less need for dewatering during construction which could affect adjacent structures. Stations would probably have to be with side platforms and fare collection will have to be at the street level, with people going back to street level if they miss the direction of their travel. This would have to be looked at together with the necessary soil cover for using TBM's for the tunnels adjacent to stations, potential depth of such created platforms in relation to the OBC limits of escalator heights, various stakeholder requirements, etc. It is understood that this possibility may vary from station to station.	Noted	
5	ENG-STR	ppetrovi-4	Conceptual Design Report	3.3.8 - TTC DM-0301-02 Clause 3.3.6 about fan induced airflows should be taken into consideration for at grade portions of the station structures as well (not just u/g) when designing ventilation. This should be coordinated with and the load values obtained from mechanical designers dealing with ventilation.	Noted	
6	ENG-STR	ppetrovi-5	3277670 Conceptual Design Report Working Draft v4	10.1.2 - Bridge type descriptions in table 10-1 should be the same as sub-headings in the text 10.1.2.1 to 10.1.2.6.	Change made	
7	ENG-STR	ppetrovi-6	3277670 Conceptual Design Report Working Draft v4	10.4.3 - Non-redundant structures are also covered in TTC DM-0301-03 Fig. 2.6, note #3 (approved Mar 10, 2011).	Noted	
8	ENG-STR	ppetrovi-7	3277670 Conceptual Design Report Working Draft v4	10.7.1 - The first sentence is missing the estimated weight of steel.	Reference to estimate weight of steel has been removed.	
9	ENG-STR	ppetrovi-8	3277670 Conceptual Design Report Working Draft v4	13 - The second last bullet is missing the estimated number of properties required for running structures.	The running structure is primarily under Yonge Street and the property requirements have been identified at the stations only.	
10	ENG-DC	plaurin-1	3277670 Conceptual Design Report Attachment 1	Section 3.3.4 - NFPA-130 as a whole to be complied with; not just the section(s) stated under OBC.	Noted	
11	ENG-DC	plaurin-2	3277670 Conceptual Design Report Attachment 1	Section 3.3.5 - The TTC Standards, including the Design Manual, have undergone major changes in the last few years, and must serve as basis for future design work, subject to regular updates. One may interpret that the TTC Standards are being dismissed in this section of the report.	Noted	
12	ENG-ARC	schoi-1	CDR-Draft, 3.3.10, Train Loading, page 23	The arrangement of vertical circulation may not be as much concerned as now , when passengers can freely move from one car to the other in Rocket cars which will be in service. Rocket will ease passenger loading and unloading problems.	Noted	
13	ENG-ARC	schoi-2	CDR-Draft, 3.3, Station Design, page 22	In addition to OBC 3.13 and NFPA 130, station planning and design must follow TTC's Design Manual for space and maintenance requirements.	Noted	
14	ENG-ARC	schoi-3	CDR-Draft, 5.2.1, Cummer Station, page 28	Should read Cummer instead of Clark for the main entrance location.	Change made	
15	TESS	lbercier-1	Section 3.3.3 Security - CPTED	Reference to CPTED is appreciated as it is an important aspect of all modern security strategies. To clarify, CPTED are sets of "principles", not rigid requirements, that when appropriately applied to a given build environment can help create safer conditions for legitimate users, and discourage abnormal users. Attention to these principles should run through all phase of design, from early Concept to Construction. It is strongly recommended that project team include a security expert with experience in application of CPTED principles, preferably in a mass public transit application. At minimum, an Architect certified and experienced in CPTED. Note that the in house resource conducting basic review in this area is eliminated.	Noted	

Item	Section	Reviewer	Dwg. # / Spec Section / Page #	Comment	Response	Action
16	TESS	Ibercier-2	Section 3.3.3 Security - holistic approach	Mass transit infrastructure security may require more than CPTED. An informative reference is the FTA publication "Transit Security Design Consideration".	Noted	
17	TESS	Ibercier-3	Section 3.3.3 Security - Critical rooms and asset protection	Areas/rooms with equipment/systems deemed critical to the continued operation should be identified as "Red", "Yellow", "Green" and consideration given to provide commensurate modern security measures/technology (i.e. electronic access control, intrusion detection.) These areas/rooms may include communication rooms, some electrical rooms, signal/ATC rooms, as well as tunnel sections where train will be stored. Recommend that project team include a security expert with experience in the design of security systems in a subway system.	Noted	
18	ENG-E&P	MMenon-1	Page 14	Substation shall be constructed on grade level, elevated Substation structure not acceptable.	Noted	
19	ENG-E&P	MMenon-2	Page 19, section 3.1.2	Design and construct Substation on grade level, elevated structure not acceptable.	Noted	
20	ENG-E&P	MMenon-3	Page 22, section 3.3.5	Provide reference of TTC Design Manuals of various disciplines as a guideline for detail design tasks.	Noted	
21	ENG-E&P	MMenon-4	Page 23, section 3.3.12	Add "Wall & Ceiling finish material colour shall be neutral, e.g.. white to facilitate reduction in lighting illumination level losses"	Change made	
22	ENG-E&P	MMenon-5	Page 28, section 5.2.1 & 5.2.3	Two level substation structure is not acceptable, provision of a single level on grade substation structure shall be considered.	Noted	
23	ENG-E&P	MMenon-6	Page 33, section 6.4, fig 6.6	Add approximate distance between substations	Noted	
24	ENG-E&P	MMenon-7	Page 34, section 6.6	place astrich on "passenger information system display"	Change made	
25	ENG-E&P	MMenon-8	Page 35, section 6.7, fourth para last sentence	Replace "A ventilation fan room housing a single fully reversible fan will also be provided at the northerly end of the Train Storage Facility to assist in the ventilation of the tunnels north of Richmond Hill Centre Station" with "Two ventilation Fan rooms housing Two half capacity fans, fully reversible will also be provided at the northerly end of the Train Storage Facility to assist in the ventilation of the tunnels north of Richmond Hill Centre Station"	Change made	
26	ENG-E&P	MMenon-9	Page 35, section 6.7, fig 6.8	Suggest to include Station name tags in the figure.	Noted	
27	Safety	tjoseph-01	page 28 - Cummer Station	Cummer Station location makes reference to "Clark Avenue & Yonge Street." Should read "Cummer Avenue & Yonge Street".	Change made	
28	Safety	tjoseph-02	page 28 - Steeles Station	In designing the track/tunnel layout for Steeles Station, will consideration be given to a future secondary routing, specifically connection to the Spadina Line?	No secondary routes were considered	
29	Safety	tjoseph-03	page 29 - Walkways	It should be mentioned somewhere in this document that the design of the track & tunnel will not create any zero-clearance areas for workers at track level.	Change made	
30	Safety	tjoseph-04	page 29 - Walkways	Will the train storage facility north of RHC Station have the same safety walkways for personnel to use when accessing trains?	Yes	
31	Safety	tjoseph-05	Page 30 - Emergency Exits	Consider additional emergency access points (i.e. fighter fighters ladders) north of RHC Station. A full storage facility (12 trains in close proximity underground) is a unique situation for the TTC and consideration should be given to whether or not the EEB 600m north of the platform provides sufficient emergency access/egress in the event of a fire/smoke in the tunnel, etc.	Additional access points can be considered during the TPAP for the storage facility and subsequent design stages	
32	Safety	tjoseph-06	Page 63 - Train Storage Facility	If this facility will be used for minor cleaning & minor maintenance, consideration should be given to making access points and walkways wide enough to bring tools, carry bags of garbage, brooms, etc. safely to and from the stored trains.	Access is provided at the north end of the facility for staff and equipment.	
33	Safety	tjoseph-07	Page 63 - Train Storage Facility	Is there a need for additional crossovers north of RHC Station to facilitate navigation around disabled trains?	Additional crossovers were removed through discussions with TTC operations.	
34	Safety	tjoseph-08	Page 23, Section 3.3.8 Ventilation	Consideration should be given to make all ventilation grills located above grade. This will prevent maintenance issues, as well, it will prevent against infiltration of flammable liquids should there be a spill on the surface.	Noted	
35	Safety	tjoseph-09	Page 63 - Train Storage Facility	The bottom diagram indicates a fan room at the north end of the train storage facility. This this a simple ventilation fan or is this a fire ventilation fan engineered for smoke exhaust? There is a substantial fire load being housed in this underground facility. If this is not a fire ventilation fan, it should be converted to one.	Noted	
36	Safety	tjoseph-10	Page 63 - Train Storage Facility	The underground train storage facility must be fitted with an automatic dry fire sprinkler system over the storage tracks, in addition to a dedicated dry standpipe system. There is a substantial fire load that could be expected to spread throughout numerous trains in short order. This will be a high challenge fire for the responding firefighters to fight, therefore a fixed fire protection system must be installed.	The facility will be designed to meet the appropriate design standards.	
37	Safety	tjoseph-11	Toronto Green Development Standard	Please make sure all Toronto stations are designed in compliance with the Toronto Green Development Standard.	Noted	
38	Safety	tjoseph-12	O.Reg. 347	During construction, please make sure all waste is managed according to O.Reg 347	Noted	

SECTION DESIGNER RESPONSE TO COMMENTS:
 1 - WILL COMPLY
 2 - DISCUSS - CLARIFICATION REQUIRED
 3 - NOT APPLICABLE BECAUSE ...

Item	Section	Reviewer	Dwg. # / Spec Section / Page #	Comment	Response	Action
39	Safety	tjoseph-13	O.Reg. 524	Please ensure air and noise Certificates of Approvals are applied for well in advance of construction start date(s).	Noted	
40	Safety	tjoseph-14	Section 15 Future Work and Next Steps Corporate Policy 10.17.1 SYSTEM SAFETY REVIEW	Consistent with Corporate Policy 10.17.1, it is suggested that the development of a System Safety Program Plan (ref. MIL-STD-882) be added as one of the next steps under Section 15. Hazards identified now can then be addressed through the early design stages wherever possible thereby reducing safety risk, project risk, and cost.	Noted	
41	Safety	tjoseph-15	Section 15 Future Work and Next Steps	The speed profile of the route was not included in the subject report. With consideration of the horizontal curves specified in Section 5, the superelevation through those curves, and maximum cant deficiency permissible by the vehicle (ref. TTC Design Manual), etc.; please consider establishing the speed profile and requesting interface review and sign-off from Service Planning, T&S (Signals), and Rail Vehicle Projects. If the speed profile is to be captured elsewhere, please reference it in the Conceptual Design Report for traceability.	Speed profile was not prepared as part of this project.	
42	Safety	tjoseph-16	General System Safety Plan: 2.7 MANAGEMENT OF SYSTEM CHANGES	Further to Comment #17, to ensure that carbody and undercar clearances, rail to wheel interfaces, traction power collection interfaces, and signalling interfaces, etc. are all properly considered, please include RC&S Rail Vehicle Projects in the review and approval process for this and all future applicable design documentation.	Noted	
43	Safety	tjoseph-17	PEDs	Safety Department is recommending that PED installation shall be part of the station design project and not a separate task completed at a later date. Inclusion of PEDs into the new stations offers a great opportunity to increase customer safety and reduce delays.	PEDS are not part of the current design.	
44	Safety	tjoseph-18	Station Roof Access and Fall prevention	It is recommended to adopt the following policies: 1) All roof access are to be provided with permanent access stairways. 2) All roof to roof access should be provided with suitable permanent stairs. 3) Permanent fall prevention measures like guard rails are to be provided around all roof perimeters. This would reduce exposure to fall hazards and enable workers to transport tool and equipment to the roof in a safe manner.	Noted	
45	Safety	tjoseph-19	General - Embedded Utilities	The ideal would be that there are no embedded utilities any where in the station structure. However, due to the limitations in the technology used to identify embedded utilities it is very important that the contractor provide a plan to accurately record the location and depth below finished surface of all embedded utilities and that information be provided to the TTC when the project is complete.	Noted	
46	Plant	dmeadus - 1	2. ARCHITECTURAL DESIGN PHILOSOPHY, Page 2	From Design Report stated: 'Unfortunately the ceilings in this and other stations were removed in order to reduce cost'. Plants Comment: Preferred no ceilings.	This section has been removed from the report.	
47	Plant	dmeadus - 2	2.3 Yonge Subway Extension Concept, Page 8	Plants Comments: Cleaning tall glazing sections are difficult. Minimize size of glass section.	Noted	
48	Plant	dmeadus - 3	2.3 Yonge Subway Extension Concept, Page 10	Plants Comment: Cleaning a tall glazing sections are difficult. Minimize size of glass sections. (Typical Concept)	Noted	
49	Plant	dmeadus - 4	2.3 Yonge Subway Extension Concept, Page 12	From Design Report stated: ...to take a fresh look at materials considering; wear, life expectancy, cost maintainability and sustainability. Plants Comment: Requires additional reviews on proposed finish materials.	Noted	
50	Plant	dmeadus - 5	3.3.13 FINISH MATERIALS, Page 23	From Design Report stated: ...to take a fresh look at materials considering; wear, life expectancy, cost maintainability and sustainability. Plants Comment: Requires additional reviews on proposed finish materials.	Noted	
51	ENG-E&P	smajdi-1	3277670 Conceptual Design Report Working Draft v4	Projected ridership at Langstaff/ Richmond Hill Centre Station should be matched with Markham/ Richmond Hill planned population and employment forecasts.	Current land use, employment, growth and population numbers were provided by York Region and used in the modelling	Ridership model to be reviewed at the beginning of detailed design to reflect the most current land use data available.

Item	Section	Reviewer	Dwg. # / Spec Section / Page #	Comment	Response	Action
52	ENG-E&P	smajdi-2	3277670 Conceptual Design Report Working Draft v4	Population and employment forecast for the study area should be confirmed with Markham projections.	Modelling input information was provided to Markham for their confirmation.	
53	ENG-E&P	smajdi-3	3277670 Conceptual Design Report Working Draft v4	Passenger demand forecast which have been updated in 2010 to include updated 2031 York Region and City of Toronto land use forecasts should be matched with Markham Growth projection.	Modelling input information was provided to Markham for their confirmation.	
54	ENG-E&P	smajdi-4	3277670 Conceptual Design Report Working Draft v5	Future development potential adjacent to Royal Orchard station should be checked with Markham/ Vaughan. This station is deleted based on low projected subway ridership volume. We should double check the assumptions before deleting this station.	Current and future land use, employment, growth and population numbers were provided by York Region and used in the modelling	YRRTC and TTC to monitor changes to planned land use in the vicinity of Royal Orchard Station. Changes that result in an increase in ridership above minimum TTC standards may trigger a review of the decision to not construct Royal Orchard Station.
55	ENG-E&P	smajdi-5	3277670 Conceptual Design Report Working Draft v6	Given the history and past Markham Council resolutions on the Langstaff/ Richmond Hill Mobility Hub station location and Yonge subway we should meet to discuss such.	Meeting is scheduled for March 2, 2012	A future presentation to Markham Council will be prepared
56	ENG-E&P	smajdi-6	3277670 Conceptual Design Report Working Draft v7	Why are the models coded to represent just AM peak period transit network for the year 2031. Shouldn't we model the transit network for the PM peak period as well.	Ridership volumes are typically highest in the am peak direction. Volumes were used to ensure stations and facilities are appropriately sized. PM peak period volumes are typically lower and the AM period is the "worst" case	
57	ENG-E&P	smajdi-7	3277670 Conceptual Design Report Working Draft v8	Recent land use planning along Yonge street corridor should be reviewed with Markham.	Current and future land use, employment, growth and population numbers were provided by York Region and used in the modelling	
58	ENG-E&P	smajdi-8	3277670 Conceptual Design Report Working Draft v9	We would like to review the drainage issues, dewatering impacts and SWM control reports for this project at appropriate time.	A full analysis of drainage, dewatering and SWM will be undertaken during detail design. Additional design details will be provided to Markham for their review at the appropriate time.	Drainage, Dewatering, and SWM Reports to be prepared and provided to Markham for review during detailed design.
59	ENG-E&P	smajdi-9	3277670 Conceptual Design Report Working Draft v10	Longbridge parking location should be discussed with Markham and Vaughan in respect to the operation of the intersection.	The operation of the proposed intersection was discussed.	A future presentation to Markham Council will be prepared
60	ENG-E&P	smajdi-10	3277670 Conceptual Design Report Working Draft v11	Future location of surface facilities; Vent shafts, Substations, Emergency access, Taxi facilities, Bus facilities and Commuter parking need to be reviewed with Markham at the appropriate time.	The location of these facilities are conceptually shown on the current set of drawings for review and comment. Additional design details will be provided to Markham for their review during detailed design.	Markham to be consulted about the location of vent shafts, substations, emergency access, taxi facilities, bus facilities, and commuter parking during detailed design.
61	ENG-E&P	smajdi-11	3277670 Conceptual Design Report Working Draft v12	At the appropriate time we would like to review traffic management plans, adequate staging and appropriate decking for cut and cover sections to minimize interruption to travel.	Additional design details will be provided to Markham for their review at the appropriate time.	Complete a full construction staging/traffic management report during detailed design. Markham to be issued a copy of the report(s) for comment.
62	ENG-E&P	smajdi-12	3277670 Conceptual Design Report Working Draft v13	At the appropriate time we would like to review details of proposed road widening and how best to acquire such.	Steeles Avenue is being shifted to the south into the City of Toronto to provide a bus portal and maintain the existing number of lanes on Steeles. There is no road widening proposed on Yonge Street, only temporary works during construction.	
63	ENG-E&P	smajdi-13	3277670 Conceptual Design Report Working Draft v14	Town would like to have future input into the architectural/ urban design/ sustainability initiatives and Streetscaping at stations.	Additional design details will be provided to Markham for their review at the appropriate time.	Markham to be consulted on architectue, urban design, sustainability initiatives and streetscaping during detailed design.
64	ENG-E&P	smajdi-14	3277670 Conceptual Design Report Working Draft v15	At the appropriate time we would like to review any proposed municipal servicing relocation and coordinate future new infrastructure required to accommodate growth in the Yonge corridor.	Additional design details will be provided to Markham for their review at the appropriate time.	Markham to be consulted on impacts to municipal services (existing and planned) during detailed design.
65	ENG-CIVIL	ahassain-1	Yonge Subway SWM Report - August 2011	West SWM pond, west catchment area: The west SWM pond is proposed within the valley land of the East Don River. SWM ponds within valley lands are not acceptable by the Town and the TRCA. We recommend that the consultant investigating other alternate options including different location outside of the existing valley lands. Subject to the MOE and TRCA's approvals, underground detention system can provide similar stormwater quality and quantity controls.	The west SWM pond outlets to East Don River, and both are located in Vaughan. We will reconfirm SWM requirements with Vaughan. The pond is confirmed to be located outside of TRCA's regulation limit and above the 100 year flood level. Pond treatment is preferred over the high capital cost of underground detention systems.	During detailed design, review Vaughan SWM criteria to ensure the SWM pond west of the Langstaff Commuter Parking Lot meets or exceeds all criteria.
66	ENG-CIVIL	ahassain-2	Yonge Subway SWM Report - August 2011	It is the Town criteria that SWM pond shall be located outside of 100 yr flood level of receiving watercourse and the SWM pond outlet shall be placed in such a way that there is no impact on the operation of the SWM pond during the 100yr storm event within the East Done River. Details regarding the proposed west SWM pond is currently not available in the report so please keep in mind that the above criteria must be considered at the detail design stage.	The pond is located within Vaughan and we will confirm their requirements with them. The pond is located outside of TRCA's regulation limit and above the 100 year flood level.	

Item	Section	Reviewer	Dwg. # / Spec Section / Page #	Comment	Response	Action
67	ENG-CIVIL	ahassain-3	Yonge Subway SWM Report - August 2011	East SWM pond, east catchment area: As mentioned in the report, the east part of the site drains easterly toward Yonge Street and runoff collected by the road side ditches enters into an existing 900mm diameter storm sewer that ultimately discharges to Pomona Mills Creek. The controlled release rates from the proposed east SWM pond shall be designed considering the capacity of the Yonge Street storm sewer capacity besides the allowable TRCA unit flow rate to Pomona Mills Creek (whichever is more conservative). Please verify the post development flow rates from the east catchment area and confirm the capacity of the Yonge Street storm sewer.	Post development flows are less than existing flows. The capacity of the 900mm sewer will be confirmed during subsequent design phases.	During detailed design, review capacity of the 900mm storm sewer on Yonge Street at Langstaff Station.
68	ENG-CIVIL	ahassain-4	Yonge Subway SWM Report - August 2011	Since the parking lot generates oil and grit pollutants, Oil/Grit Separator facilities will be required to control water quality as per MOE guidelines.	SWM ponds are preferred for drainage areas of 5 ha or greater. To use an OGS to treat the parking lot will require a very large and custom-made OGS because the area to be treated is greater than 5 ha. In addition to SWM ponds we are also providing enhanced grassed swales and vegetated filter strips to provide additional treatment.	
69	ENG-CIVIL	ahassain-5	Yonge Subway SWM Report - August 2011	There is an existing SWM pond (probably servicing HWY 407) north-west side of the subject site. We recommend looking at opportunities to utilize this pond as a centralized facility to service the west catchment area of the subject site.	We were unable to obtain any design information on the 407 SWM pond. Without any design information (drainage area, level of control, outlet control structure, stage-discharge-storage data, etc.) it would not be able to carry out any modelling to confirm if the existing pond can be enlarged. That was our first option. We requested for the design information and was advised that the information was not available.	During detailed design, review potential benefits of expanding the existing SWM pond northwest of the Langstaff Commuter Parking Lot to accommodate additional parking lot runoff. If there is a perceived benefit, consult the pond owner to see if expanding the pond is a viable solution.
70	ENG-CIVIL	ahassain-6	Yonge Subway SWM Report - August 2011	The soil type and ground water elevation play a vital role in the design of SWM facilities (ponds, LID, etc.). Please provide the geotechnical report including groundwater information for the site.	Geotechnical investigation will be carried out during detailed design stage. Based on the geotechnical investigation, the design of the SWM facilities will be re-visited.	During detailed design, collect geotechnical information to inform the design of the SWM ponds for the Langstaff commuter parking lot.
71	ENG-CIVIL	ahassain-7	Yonge Subway SWM Report - August 2011	A complete capacity analysis for the pipe system from Yonge street to Pomona Creek should be done. We need to understand what constrains we have in order to determine if the on-site SWM measures are adequate for the site. We should avoid surcharging the existing storm sewer at all cost.	Post development flows are less than existing flows. The capacity of the 900mm sewer will be confirmed during subsequent design phases.	During detailed design, review capacity of the 900mm storm sewer on Yonge Street at Langstaff Station.
72	ENG-E&P	kllewellyn-thomas-1	Infrastructure Planning Branch and Strategic Policy and Business Planning Branch	Opening day ridership demand is not well documented and the report provides limited information for future transit service planning. It is recommended that future stages of design studies provide more detail on opening day ridership in order to better coordinate surface routing and services upon subway opening	With no funding in place, the opening date for the system is unknown, 2031 was used for planning purposes.	Ridership model to be reviewed at the beginning of detailed design to reflect the most current land use data available.
73	ENG-E&P	kllewellyn-thomas-2	Infrastructure Planning Branch and Strategic Policy and Business Planning Branch	Section 6-6 should consider incorporating telecommunications infrastructure and technologies in the station designs to provide users with real time information and communication convenience, and coordinate with the Region's ITS Strategy	Subsequent design studies will review passenger ITS requirements.	During detailed design, liaise with York Region to discuss the Region's ITS Strategy and opportunities to incorporate ITS into the design.
74	ENG-E&P	kllewellyn-thomas-3	Infrastructure Planning Branch and Strategic Policy and Business Planning Branch	The draft report indicates an increase in peak passenger demands of about 2,000 (i.e., going from 12,000 to 14,000) between years 2021 to 2031. How does this compare with the population/employment growth rate and land use projections for the Richmond Hill/Langstaff area and York Region in general?	Current and future land use, employment, growth and population numbers were provided by York Region and used in the modelling	
75	ENG-E&P	kllewellyn-thomas-4	Infrastructure Planning Branch and Strategic Policy and Business Planning Branch	Although the term "mobility hub" is mentioned in the report, Section 6 (station design) should emphasize that the stations such as Richmond Hill/Langstaff need to follow Metrolinx's Mobility Hub Guidelines and include multi-modal facilities/connections including provisions for active transportation (e.g., bike parking spaces). Considering the significance of the project and the Richmond Hill Centre station as the "Union Station" of York Region, the design of this station could be more prominent in terms of urban design elements and integration with the surrounding development potential	These requirements will be further developed during subsequent design studies.	Review Metrolinx Mobility Hub Guidelines during detailed design.
76	ENG-E&P	kllewellyn-thomas-5	Infrastructure Planning Branch and Strategic Policy and Business Planning Branch	It is acknowledged that a detailed traffic/construction management plan will form part of the next stage of design studies and more consideration of the logistics are being documented in this study report including the lane constraints over the East Don River. However, the impact of the Yonge construction on the parallel routes (Bayview and Bathurst) and temporary improvements to relieve the potential traffic impacts during construction should be addressed in future traffic management plans including specific road and transit improvement measures and cost associated with the mitigation	Noted	Assess impacts on parallel roads when developing the traffic management plan for the project.

Item	Section	Reviewer	Dwg. # / Spec Section / Page #	Comment	Response	Action
77	ENG-E&P	kllewellyn-thomas-6	Infrastructure Planning Branch and Strategic Policy and Business Planning Branch	The stations have been designed in isolation of potential redevelopment of sites (e.g. Centrepoin Mall). Maximum flexibility should be incorporated in the station designs to integrate with potential re-development in the surrounding areas.	Flexibility for connections to adjacent development has been included at all stations, connections to developments will be maximized in future studies.	
78	ENG-E&P	kllewellyn-thomas-7	Infrastructure Planning Branch and Strategic Policy and Business Planning Branch	Figure references in the report need to be confirmed. For example, in Chapter 6, Figures 4-6, 6-1, 6-2 are referenced incorrectly.	Changes made	
79	ENG-E&P	kllewellyn-thomas-8	Infrastructure Planning Branch and Strategic Policy and Business Planning Branch	The report recommends a new Transit Project Assessment Process for the underground train storage facility located north of the RHS Station. It is suggested that this change in the design of the Yonge Subway Extension could be dealt with as an addendum to the existing Yonge Subway Extension Transit Project Assessment along with any other significant revisions, including the proposed elimination of the Royal Orchard Station	The underground storage facility must follow a new TPAP as it was beyond the Study Area of the original project.	
80	ENG-E&P	kllewellyn-thomas-9	Infrastructure Planning Branch and Strategic Policy and Business Planning Branch	Section 6.2 Architectural Design Philosophy (add bullet) "Coordination and integration with the South Yonge Street Corridor Streetscape Master Plan Study"	Change made	
81	ENG-E&P	kllewellyn-thomas-10	Infrastructure Planning Branch and Strategic Policy and Business Planning Branch	Section 6.3 Station Design Guidelines - second sentence - delete and replace with "While the YSE is primarily to be located under Yonge Street, it is critical that station areas support existing land use policies that recognize Yonge Street as a primary inter-regional corridor and requires the highest quality of urban design"	Change made	
82	ENG-E&P	kllewellyn-thomas-11	Infrastructure Planning Branch and Strategic Policy and Business Planning Branch	Please provide further clarification on how the YRT route 99 will access the Steeles Avenue Station Bus Terminal	YRT 99 will stop on street at Yonge and Steeles and will use the future road network in Vaughan to turn around and return to the north. YRT 99 will not have direct access to the underground bus terminal.	
83	ENG-E&P	kllewellyn-thomas-12	Infrastructure Planning Branch and Strategic Policy and Business Planning Branch	Section 9.8 Utilities and Relocation Strategy - Please clarify if an opportunity exists to bury hydro infrastructure at this location gives costs would be incurred anyway due to the relocation of hydro during construction plus the required improvements identified at this location	Opportunities to improve the existing infrastructure will be reviewed during subsequent design studies.	
84	ENG-E&P	kllewellyn-thomas-13	York Region Transit	In the absence of the northern portal, please provide further clarification on which routing the YRT/Viva Route 99 - Yonge St will access the Steeles Avenue Station Bus Terminal given the limited on-street routing options	YRT 99 will stop on street at Yonge and Steeles and will use the future road network in Vaughan to turn around and return to the north. YRT 99 will not have direct access to the underground bus terminal.	
85	ENG-E&P	kllewellyn-thomas-14	York Region Transit	YRT/Viva identifies the need for 6 bus bay platforms within the Steeles Station terminal. The Conceptual Design Report identifies provision for only 5 bus bays.	The Viva Blue bay has not been included as it was assumed that this service would terminate at Richmond Hill Centre and not run down Yonge Street in mixed traffic along the same alignment as the subway.	
86	ENG-E&P	kllewellyn-thomas-15	Steeles Station-Section 8.1	The first paragraph indicates that the passenger demands forecast analysis is found in the Section 4 and in Appendix A. The analysis is actually found in Section 2. Also, the report does not include Appendix A nor any other appendices (CD was not included in the draft report circulation)	Change made	
87	ENG-E&P	kllewellyn-thomas-16	Steeles Station-Section 8.1	Table 8-1 indicates the forecasted 2031 AM peak hour transfer movements by mode and direction for Steeles Station. Movements into/out of the station are shown for YRT routes coming from the east and west, but not from the north, i.e. via Route 99. Although many Route 99 customers who will be getting on/off at Steeles Station. For completeness, the Route 99 component of overall demand should be identified in the table	It was assumed that route 99 passengers destined for the subway would access the subway at the closest station. The passengers transferring at Steeles would only be the passengers picked up between Clark and Steeles.	
88	ENG-E&P	kllewellyn-thomas-17	Steeles Station-Section 8.2	Route 88 could access the underground bus terminal from the west portal, and Route 91 could access the underground bus terminal from the east portal. However, as mentioned in third paragraph of Section 8.2, the Plan no longer includes a northern portal on Yonge Street. As such, it is critically important to determine and show which portal, and which specific routing, Route 99 would use to access its stop location in the underground bus terminal	YRT 99 will stop on street at Yonge and Steeles and will use the future road network in Vaughan to turn around and return to the north. YRT 99 will not have direct access to the underground bus terminal.	

Item	Section	Reviewer	Dwg. # / Spec Section / Page #	Comment	Response	Action
89	ENG-E&P	kllewellyn-thomas-18	Steeles Station-Section 8.2	Table 8-2 indicates Proposed Bus Bay Allocation at Steeles Station. It shows 1 bay each required for Routes 88, 91 and 99, plus 1 for "Future Service Growth", plus 1 for "Unloading", and no dedicated bay for Mobility Plus, resulting in a total of 5 bays. Gives that the issue of fare integration with TTC has still not yet been resolved, our latest assessment indicated that we have the following needs, which should be reflected in the Report: - 1 bay each for Routes 88, 91 and 99, plus 1 bay for Viva Blue, Plus 1 for "Future Service Growth", plus 1 bay for "Unloading", resulting in a total of 6 bays. (A dedicated bay for Mobility Plus is not needed here at Steeles Station)	The Viva Blue bay has not been included as it was assumed that this service would terminate at Richmond Hill Centre and not run down Yonge Street in mixed traffic along the same alignment as the subway.	
90	ENG-E&P	kllewellyn-thomas-19	Clark Station - Section 9.1	The first paragraph indicates that the passenger demands forecast analysis is found in the Section 4 and in Appendix A. The analysis is actually found in Section 2. Also, the report does not include Appendix A nor any other appendices	Change made	
91	ENG-E&P	kllewellyn-thomas-20		Table 9-1 indicates the forecasted 2031 AM peak hour transfer movements by mode and direction for Clark Station. Movements into the station are shown for YRT routes headed east, north and south. However, movements out of the station to YRT routes are only shown for northbound and westbound trips, but not for southbound trips, i.e. via Route 99. For completeness, it should be explained why there is no southbound demand shown coming out of the station	Due to the close proximity of Steeles and Clark Stations, passengers destined for locations south of Clark may find it more convenient to transfer from the subway at Steeles and take route 99 northbound from that location. Updated passenger transfer numbers will be provided in subsequent design studies.	Update passenger transfer volumes during detailed design.
92	ENG-E&P	kllewellyn-thomas-21	Clark Station - Section 9.7	Table 9-2 indicates Proposed Bus Bay Allocation at Clark Station. It shows 1 bay shared between Routes 2/2A and 5, plus 1 bay shared between Routes 23 and 77, plus 1 bay shared between "Future Service Growth" and "Unloading", and no dedicated bay for Mobility Plus, resulting in a total of 3 bays (with Route 99 stopping on-street). However, our latest assessment indicates that we have the following needs, which should be reflected in the report: - 1 bay shared between Routes 2/2A and 5, plus 1 bay shared between Routes 23 and 77, plus 1 bay shared between "Future Service Growth" and "Unloading", resulting in a total of 3 bays (with Route 99 and Viva Blue stopping on-street as they currently do). There is no need to accommodate MobilityPlus here at Clark Station.	Noted	
93	ENG-E&P	kllewellyn-thomas-22	Langstaff Station - Section 10.1	The First paragraph indicates that the passenger demand forecast analysis is found in Section 4 and in Appendix A. The analysis is actually found in Section 2. Also, the report does not include Appendix A, nor any other appendices.	Change made. Appendices were only provided in digital format, not hard copy.	
94	ENG-E&P	kllewellyn-thomas-23	Langstaff Station - Section 10.1	Table 10-1 indicates the forecasted 2031 AM peak hour transfer movements by mode and direction for Langstaff Station, however no passenger movements are shown to/from YRT route, i.e. via Route 99. For completeness, it should be explained why there is no demand shown to/from YRT. Also related to Route 99... there are currently existing YRT bus-stops located at the northwest and southeast corners of the intersection of Yonge Street and Longbridge Road. However, the drawing on page 86 (i.e. "Langstaff Station Street Level") only shows the southbound YRT stop at the northwest corner. The drawing should also indicate (i) the nearby northbound stop which is located immediately south of the planned subway station location and (ii) the existing southbound stop at the Hwy407 off-ramp (opposite Langstaff Road), so that these stop can be protected.	Updated passenger transfer numbers will be provided in subsequent design studies. The location of the bus stops will be revised.	Update passenger transfer volumes during detailed design.
95	ENG-E&P	kllewellyn-thomas-24	Richmond Hill Centre Station - Section 11.1	The first paragraph indicates that the passenger demands forecast analysis is found in Section 4 and in Appendix 4. The analysis is actually found in Section 2. Also, the report does no include Appendix A, nor any other appendices.	Change made. Appendices were only provided in digital format, not hard copy.	
96	ENG-E&P	kllewellyn-thomas-25	Richmond Hill Centre Station - Section 11.2	Table 11-2 indicates the proposed YRT/Viva bus allocations and requirements at the Richmond Hill Centre Terminal. However, our latest assessment indicates that we have the following needs, which should be reflected in the Report: - MobilityPlus requires 1 dedicated bus bay to allow proper operations -the line item re: "Purple EB" should appear as "Purple/Pink EB" -the line item re: "Purple WB" should appear as "Purple/Pink WB" -the number of bays attributes to "growth" should be changed from 3 bays to 2 bays (These 2 'Growth' bays must each be able to accommodate 18m buses.) -for the "Unloading" bays, it should be indicated that the 3 bays shown should consist of two 18m bays, plus one 12m bay. -(The changes result in a net-zero change in the number of bays, i.e. total of 20 bays)	Change made	
97	ENG-E&P	pmillett-1	Page ii	Passenger Demand – There is the statement - "The ridership volumes along the line are expected to reach 165,000 daily riders by 2031." I am not quite sure where this number came from could you tell me how it was derived as I do not see any mention of it in the Demand Forecast Report.	Reference to daily riders has been removed.	

Item	Section	Reviewer	Dwg. # / Spec Section / Page #	Comment	Response	Action
98	ENG-E&P	pmillett-2	Page 2	Passenger Demand Forecast – There is the statement – “It is assumed that train service will be 12 trains per hour per direction in the AM/PM peak period to Richmond Hill with every second train short turning at Finch Station.” I believe the planned service level is north of Finch 3’30” headways or approximately 17 trains per hour and south of Finch 1’45” headways or 34 trains per hour during the AM/PM peak periods.	Change made	
99	ENG-E&P	pmillett-3	Page 3	Passenger Demand Forecast – Table 2-2 this the total link volume but this is not used appropriately as the numbers stated are the southbound and northbound numbers totalled and are not a link load but the number of passengers who pass by the station.	Change made	
100	ENG-E&P	pmillett-4	Page 3	Ridership Projection at Royal Orchard Station - The acronym VTHCD should be listed in the Glossary of Terms	Change made	
101	ENG-E&P	pmillett-5	Page 7	Fleet Size and Train Configuration - There is a statement – “To address this issue, train operations may be altered to shift the location of short turning trains from Finch to Steeles Station or extending all train service to Richmond Hill Centre Station.” Steeles Station cannot support a short turn because of the lack of a center or pocket track north of the station so we should just say - To address this issue, train operations may be altered by extending all train service to Richmond Hill Centre Station.	Change made	
102	ENG-E&P	pmillett-6	Page 18	Zone 2 – The Concourse – There is a statement – “ A prototypical plan and spatial configuration of the concourse level can be found in Figure 3-1.” This should be figure 6.1.	Change made	
103	ENG-E&P	pmillett-7	Page 20	Personal Security – The acronym CPTED should be listed in the Glossary of Terms.	Added	
104	ENG-E&P	pmillett-8	Page 20	Fare Collection – We may want to mention something about the fact that the TTC is currently investigating Presto and fare integration and the impacts the positive impact this may have on station design.	Change made	
105	ENG-E&P	pmillett-9	Section 8	Steeles Station – There is no mention of the 7.5% grade of the bus portals and the fact that it does not meet the TTC standards. Perhaps it should be mentioned and that a design variance would be required and it would be addressed by heated ramps.	Added	
106	ENG-E&P	pmillett-10	Page 111	Train Storage – There is a statement “ The northern extension of the current Spadina Subway short turn from St.Clair West Station to Glencairn Station.” I believe we should be saying to Wilson Station.	Sentence changed to reference the location of the Spadina short turn from St. Clair West to Glencairn Station.	
107	ENG-E&P	apearce-1	3277670 Conceptual Design Report - Draft	Appropriate and adequate screening/buffer between the proposed commuter parking lot and the existing neighbouring residential community.	Noted	
108	ENG-E&P	apearce-2	3277670 Conceptual Design Report - Draft	Location & operation of the Longbridge Road/commuter parking lot driveway/Yonge Street intersection (s)	Details of the proposed intersection will be developed during subsequent design studies and will be circulated to Vaughan for review.	During detailed design, circulate proposed Langstaff commuter parking lot/Yonge Street intersection design to Vaughan for review
109	ENG-E&P	apearce-3	3277670 Conceptual Design Report - Draft	Rational for the proposed deletion of the Royal Orchard station	Royal Orchard is recommended for deletion as a result of low ridership projections with little opportunity for future redevelopment.	
110	ENG-E&P	apearce-4	3277670 Conceptual Design Report - Draft	Need for a comprehensive stakeholder consultation process related to the selection of the preferred East Don River Bridge	Noted	Complete a stakeholder consultation process for the design of the East Don River Bridge.
111	ENG-E&P	apearce-5	3277670 Conceptual Design Report - Draft	Provisions for additional knock out panels for future underground connections to adjacent buildings	Flexibility for connections to adjacent development has been included at all stations, connections to developments will be maximized in future studies.	
112	ENG-E&P	apearce-6	3277670 Conceptual Design Report - Draft	An assessment of the pedestrian movements at the Steeles Station	Noted	
113	ENG-E&P	apearce-7	3277670 Conceptual Design Report - Draft	Enhanced streetscape/urban design requirements along the corridor should be addressed at this stage so the necessary funding can be included in the project budget	The project budget has included sufficient funds and contingency for streetscaping at stations.	
114	ENG-E&P	alee-1	3277670 Conceptual Design Report - Draft	As it was mentioned during the meeting, integration and phasing were not discussed in the report although the schedule indicates that the subway construction would occur prior to the RHC. It would be essential to understand what would be a minimum infrastructure requirement in order to service the station in any event that the construction of the subway occurs in advance of Town’s Regional Centre development. This would address the construction timing Noted in the report.	Noted. York Region will distribute any development applications to TTC for review and both parties will comment on how the subway and related facilities need to be protected for.	During detailed design, Richmond Hill will be consulted on status of development.
115	ENG-E&P	alee-2	3277670 Conceptual Design Report - Draft	We noticed that the elevation difference from the concourse level to the street at Richmond Hill Centre Station was greater than 8m whereas the vertical differences at other locations were about 2m. Given that some pedestrian entrances to the station would have stairs, it would not be desirable to have an elevation difference to this magnitude. We suggest that you review this matter more closely and inform us of any additional revision/impact that may require in order to achieve the desirable concourse level elevation.	Subsequent design studies will optimize the vertical alignment however the profile is controlled by the existing SWM pond within RHC and providing sufficient cover over the tunnels.	During detailed design, optimize the vertical alignment of the subway with the goal of minimizing station depth.

Item	Section	Reviewer	Dwg. # / Spec Section / Page #	Comment	Response	Action
127	ENG-E&P	City of Toronto-9	Starting on Page 24 - Cummer Station	The 2 level electrical substation proposed at the main entrance at NE corner of Yonge/Cummer may limit opportunities to integrate the main subway entrance building within future development on this corner of the intersection. Are there other options to locate this facility further away from the Yonge/Cummer intersection? For example, the substation at Steeles is located 70+ metres from the intersection to maximize the potential for adjacent transit-oriented development (TOD). It is anticipated that as a result of the current land use designation and City's study, that TOD would also occur on the northeast corner.	Opportunities to relocate the substation will be reviewed with the City of Toronto during subsequent design studies.	
128	ENG-E&P	City of Toronto-10	Starting on Page 41 - Steeles Station	Reducing the size of the bus terminal and removing the portal from Yonge St. is a significant improvement.	Noted	
129	ENG-E&P	City of Toronto-11	Starting on Page 41 - Steeles Station	Page 42 appropriately references the potential for an alternative bus terminal location within and in conjunction with redevelopment of Centerpoint Mall lands.	Noted	
130	ENG-E&P	City of Toronto-12	Starting on Page 41 - Steeles Station	As Noted above for the Cummer Station, ventilation shafts are appropriately located further from the Yonge/Steeles intersection and any additional ventilation as Noted for the bus terminal, should also be Noted on future plans and away from or integrated into the public realm and facilitate pedestrian movements to transit through the boulevard and streetscape.	Noted	
131	ENG-E&P	City of Toronto-13	Starting on Page 41 - Steeles Station	Proposed width of the centre portals and associated median on Steeles raises a number of implications/questions.	Noted. To be examined in future studies.	
132	ENG-E&P	City of Toronto-14	Starting on Page 41 - Steeles Station	Design and appearance of the portals to the bus terminal is important as it is highly visible in the middle of Steeles Avenue.	Noted. To be examined in future studies.	
133	ENG-E&P	City of Toronto-15	Starting on Page 41 - Steeles Station	SK-A-006D - the entire Steeles ROW is for landscaped median and paved roadways and does not provide for any pedestrian boulevard and sidewalks. Again, the design must provide public space for pedestrian movements and amenities in a public boulevard adjacent to private land uses.	It is proposed to reinstate sidewalks/boulevards adjacent to the reconstructed Steeles Avenue in the station vicinity. This will require acquisition of property beyond the existing roadway right-of-way.	
134	ENG-E&P	City of Toronto-16	Starting on Page 41 - Steeles Station	Would the landscaped median be designed to support trees and would TTC plant and maintain trees and landscaping?	The type/size of trees to be planted in the median may be limited due to the underground tunnel. Landscaping details for the median will be discussed during detail design.	
135	ENG-E&P	City of Toronto-17	Starting on Page 41 - Steeles Station	Overall treatment of the landscape areas in particular around vent and entrance locations and at major intersections is important and a detailed landscape plan will be necessary to support the pedestrian environment.	Noted. To be examined in future studies.	
136	ENG-E&P	City of Toronto-18	Starting on Page 41 - Steeles Station	Will the Steeles Avenue subway entrance west of Yonge and in the middle of the street include sufficient space for pedestrians to safely wait? There is concern about the proposed mid-block pedestrian crossing and the overall appearance and pedestrian functionality.	Sufficient median space can be provided to allow pedestrians a safe waiting area. The exact location of the pedestrian crossing would be detailed in conjunction with the new road network in Vaughan and future roads on the Centerpoint property.	
137	ENG-E&P	City of Toronto-19	Starting on Page 41 - Steeles Station	Public art that is visible from the streets and not just the stations will support the public realm and potential locations should be considered early in the process. Public Art is to be included for budgeting reasons as per TTC agreement with the City.	Noted. To be discussed during future studies.	
138	ENG-E&P	City of Toronto-20	Starting on Page 41 - Steeles Station	Impact of restricting access to properties currently using the centre left turn lane and potential mitigation measures.	Noted. To be examined in future studies.	
139	ENG-E&P	City of Toronto-21	Starting on Page 41 - Steeles Station	Drawing SK-A-010D shows only part of the property acquisition on the south side of Steeles Ave between Yonge St and Willowdale Ave. Need to see the design further east and west of portals and full impact of how the street transitions back to the typical cross section.	Exact property requirements will be detailed in future studies	
140	ENG-E&P	City of Toronto-22	Starting on Page 41 - Steeles Station	What happens to the current bus loop east of Yonge St?	This bus loop will be removed and the property will be used for the widening of Steeles Avenue	
141	ENG-E&P	City of Toronto-23	Starting on Page 41 - Steeles Station	How will the YRT 99 Yonge use local roads to layover and turnaround at Steeles Station? (Pg.41)	YRT 99 will stop on street at Yonge and Steeles and will use the future road network in Vaughan to turn around and return to the north. YRT 99 will not have direct access to the underground bus terminal.	
142	ENG-E&P	City of Toronto-24	Starting on Page 41 - Steeles Station	The landscaped centre median in Yonge Street should be extended further south.	Noted. To be reviewed during future studies.	

Item	Section	Reviewer	Dwg. # / Spec Section / Page #	Comment	Response	Action
143	ENG-E&P	City of Toronto-25	Priorities moving forward	<p>Recommendations from the Yonge Street North Planning Study should be incorporated into the next level of detail for the project. More specifically:</p> <ul style="list-style-type: none"> • a Traffic impact study is needed to assess the adequacy of the right-of-way width and lane capacity on Steeles and Yonge St • Traffic capacity and transportation network in the area will also be considered as part of the Yonge St North Planning Study and look at opportunities for increasing the capacity through existing or new local roads. • Portal locations/access to bus station should be considered in relation to proposed street network in surrounding development blocks. • other design options and ROW requirements could mitigate property acquisition and at the same time provide streetscape boulevard capacity and design improvements for pedestrians and transit riders • The Yonge St North Study will include proposed growth and associated local road transportation improvements and will be forwarded to the Technical Advisory Committee members (including TTC) as soon as it's completed. • traffic studies must take into consideration other planned initiatives by York Region and local municipalities • TTC Staff should also consult with York Region Staff and the 'South Yonge Street Corridor Streetscape Master Plan Study', which was adapted by York Region Council on January 26, 2012 • Opportunities and options to integrate the bus station at Centerpoint Mall should be further developed 	Noted. Recommendations will be reviewed during next level of detail for the project.	

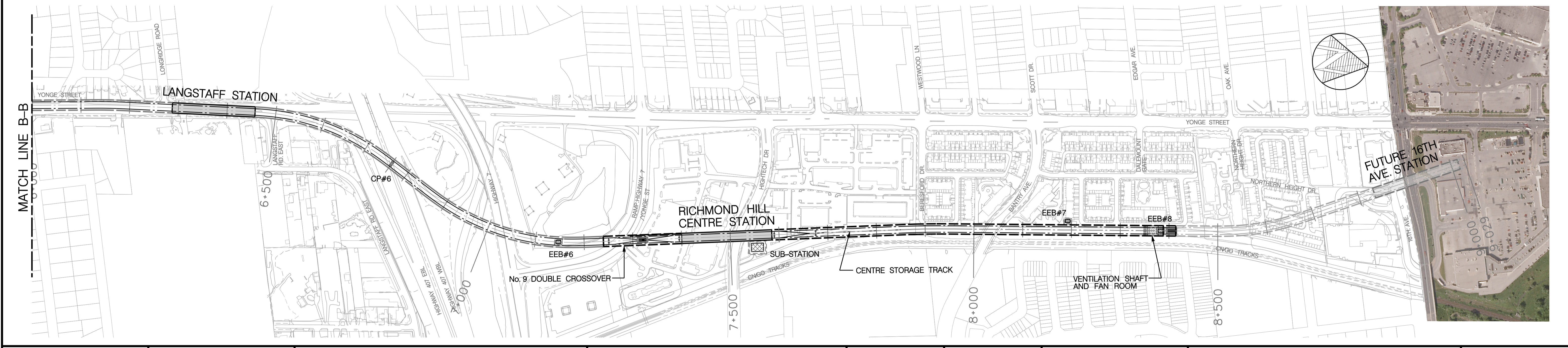
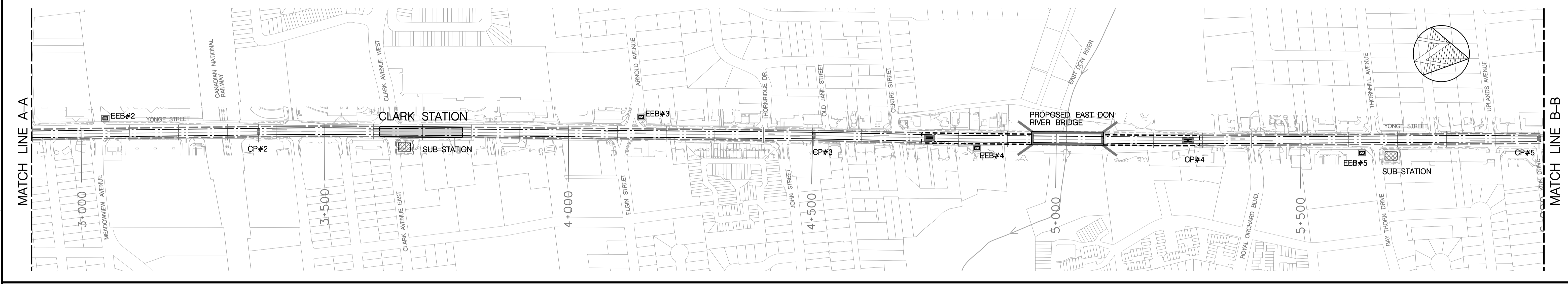

BLDG. REF. No.
 FILE
 SHEET No.
 DRAWING No.

REVISIONS	REVISIONS

**CONCEPTUAL
DESIGN**
 NOT FOR CONSTRUCTION

DRAWN
 CHECKED
 CORRECT
 SCALE

YONGE SUBWAY EXTENSION
FINCH STATION TO
RICHMOND HILL CENTRE STATION
 SITE PLAN

Plot Date: 11-08-26

 TORONTO TRANSIT COMMISSION
 ENGINEERING DEPARTMENT
 Dwg. No. G3001 Sheet No.

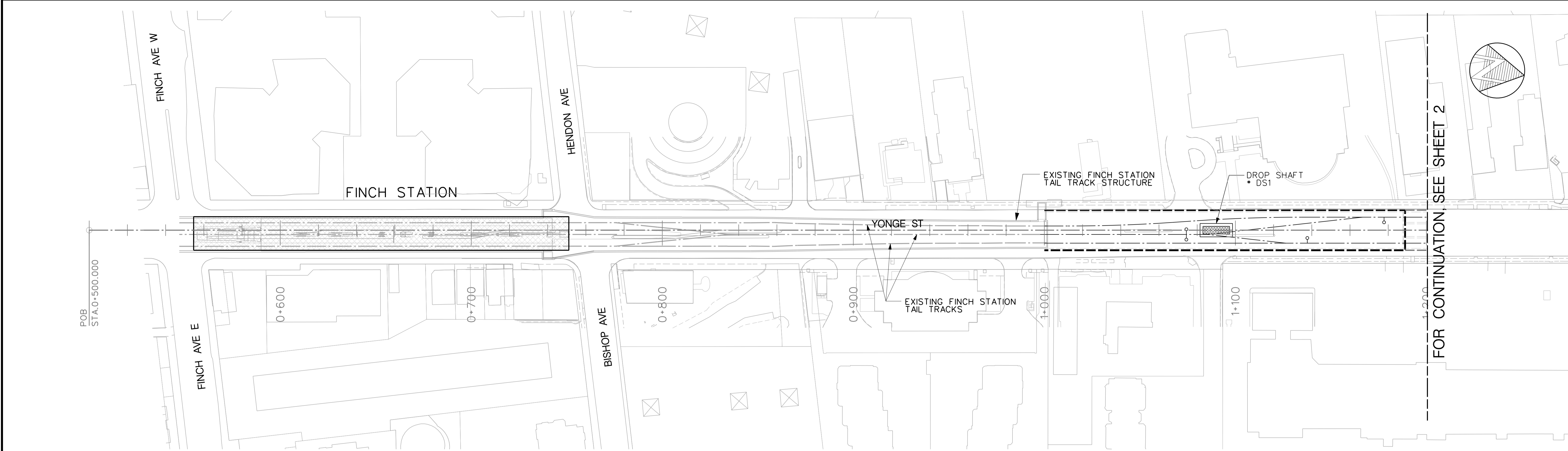

FOR CONTINUATION SEE SHEET 2

BLDG. REF. No.
FILE
SHEET No.

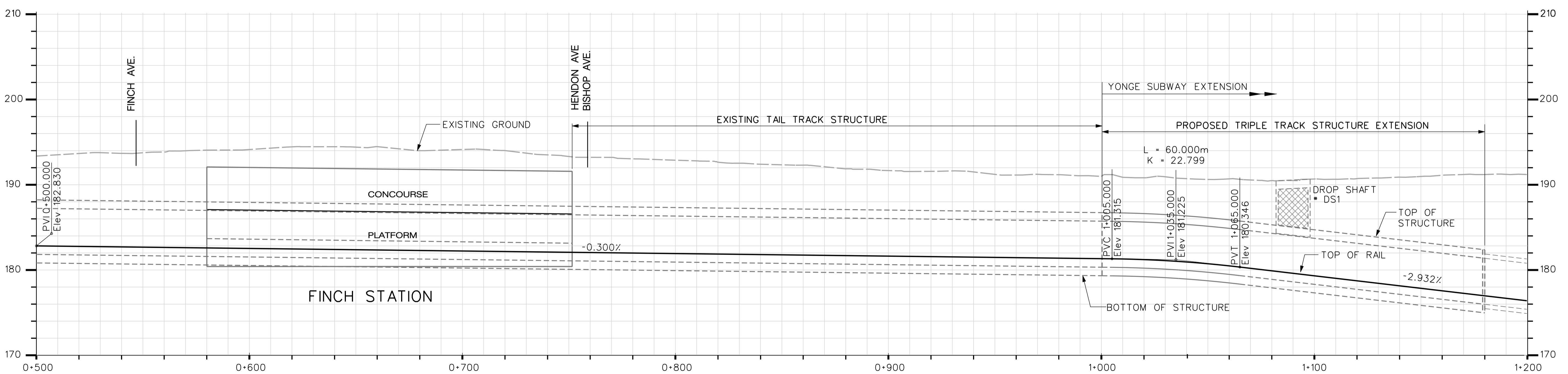

REVISIONS	REVISIONS

CONCEPTUAL DESIGN
NOT FOR CONSTRUCTION

Hatch Mott MacDonald
McCORMICK RANKIN CORPORATION
 A member of **MMM GROUP**

DRAWN _____
 CHECKED _____
 CORRECT _____

SCALE: 0 10 20 30 40m HORIZONTAL
 0 5 10m VERTICAL

YONGE SUBWAY EXTENSION
TRACKWORK ALIGNMENT
 PLAN AND PROFILE
 STA. 0+500 TO STA. 1+200

Plot Date: 11-08-22

TORONTO TRANSIT COMMISSION
 ENGINEERING DEPARTMENT

Dwg. No. _____ Sheet No. _____

SHEET 1

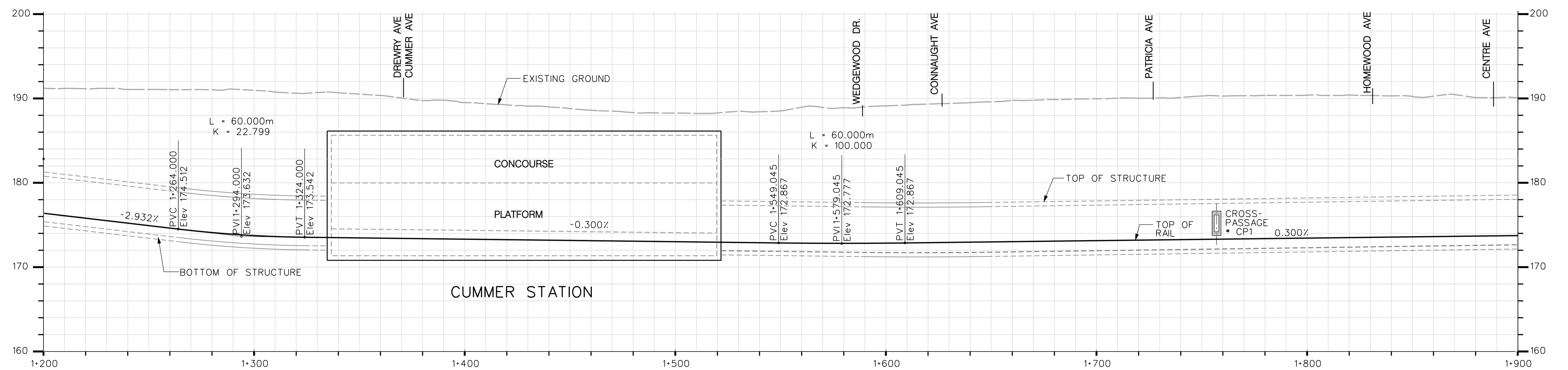
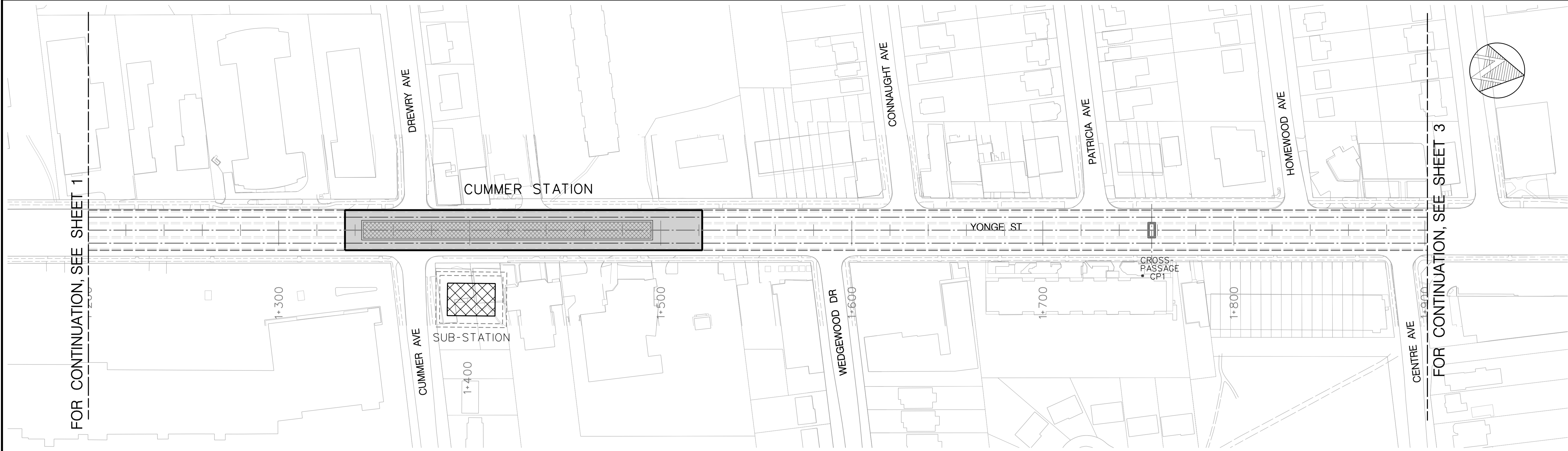

REVISIONS	REVISIONS

CONCEPTUAL DESIGN
NOT FOR CONSTRUCTION

Hatch Mott MacDonald

MRC **MCCORMICK RANKIN CORPORATION**
A member of **MMM GROUP**

DRAWN _____

CHECKED _____

CORRECT _____

SCALE: 0 10 20 30 40m HORIZONTAL

0 5 10m VERTICAL

YONGE SUBWAY EXTENSION

TRACKWORK ALIGNMENT

PLAN AND PROFILE
STA. 1+200 TO STA. 1+900

Plot Date: 11-08-22

TORONTO TRANSIT COMMISSION
ENGINEERING DEPARTMENT

Dwg. No. _____ Sheet No. _____

SHEET 2

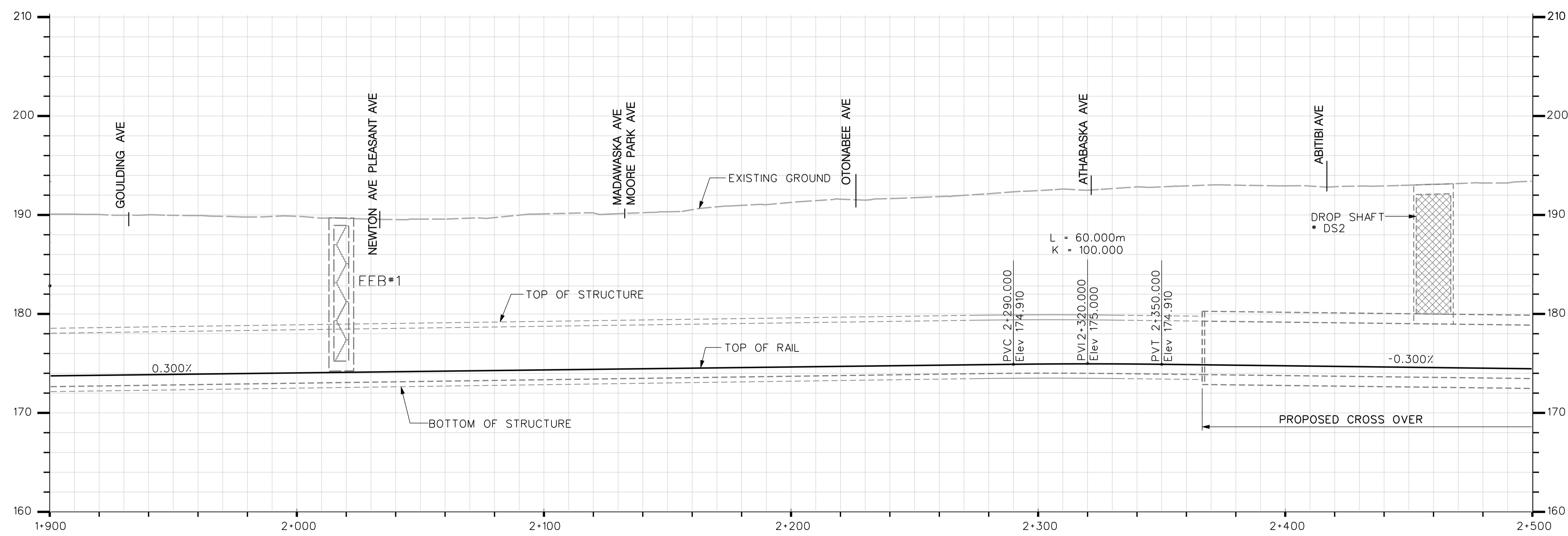

BLDG. REF. No.
FILE
SHEET No.

REVISIONS	REVISIONS

**CONCEPTUAL
DESIGN**
NOT FOR CONSTRUCTION

DRAWN _____
 CHECKED _____
 CORRECT _____

SCALE: 0 10 20 30 40m HORIZONTAL
 0 5 10m VERTICAL

YONGE SUBWAY EXTENSION
TRACKWORK ALIGNMENT
 PLAN AND PROFILE
 STA. 1+900 TO STA. 2+500

Plot Date: 11-08-22

TORONTO TRANSIT COMMISSION
 ENGINEERING DEPARTMENT

Dwg. No. _____ Sheet No. _____

SHEET 3

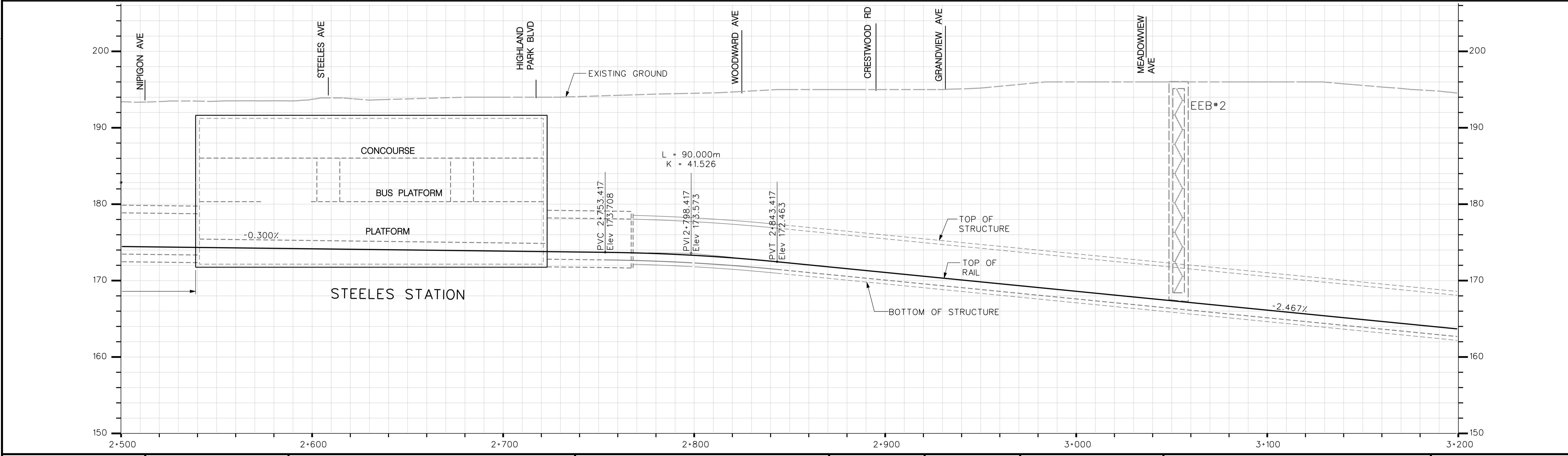
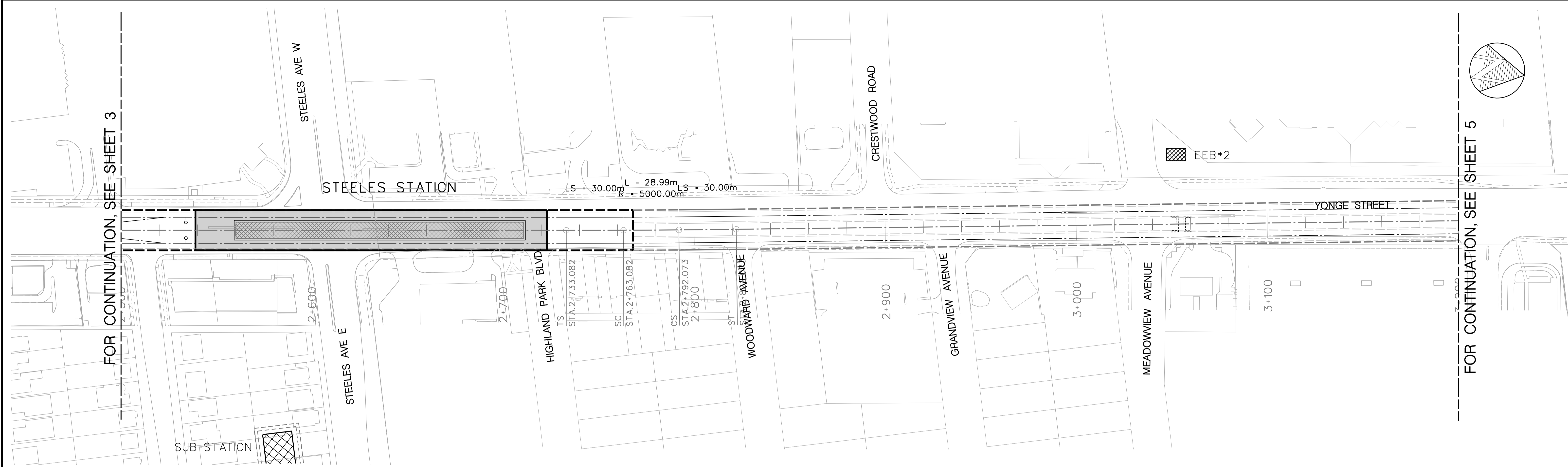

BLDG. REF. No.
FILE
SHEET No.
DRAWING No.

REVISIONS	REVISIONS

CONCEPTUAL DESIGN
 NOT FOR CONSTRUCTION

DRAWN _____
 CHECKED _____
 CORRECT _____

SCALE: 0 10 20 30 40m HORIZONTAL
 0 5 10m VERTICAL

YONGE SUBWAY EXTENSION
TRACKWORK ALIGNMENT
 PLAN AND PROFILE
 STA. 2+500 TO STA. 3+200

Plot Date: 11-08-22

TORONTO TRANSIT COMMISSION
 ENGINEERING DEPARTMENT

Dwg. No. _____ Sheet No. _____

SHEET 4

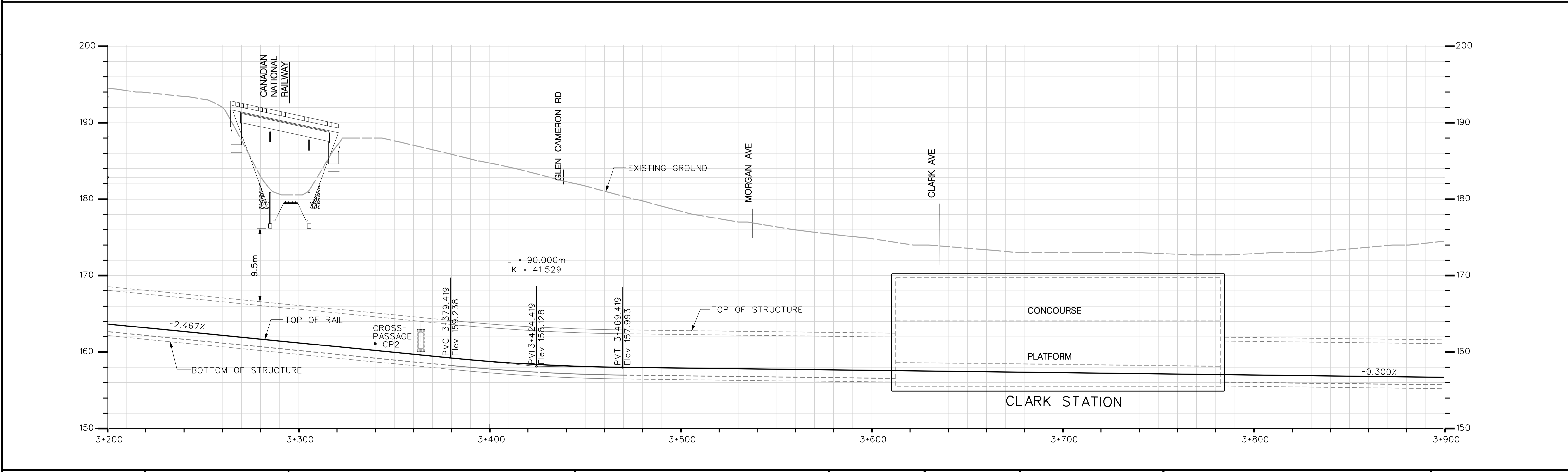
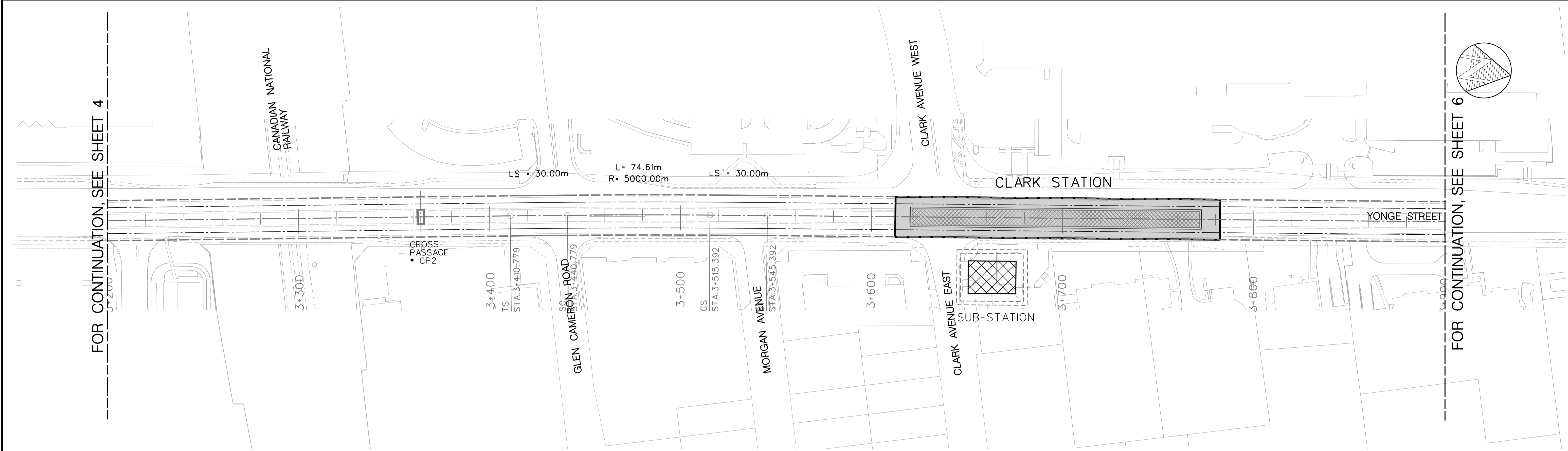

BLDG. REF. No.
FILE
SHEET No.
DRAWING No.

REVISIONS	REVISIONS

CONCEPTUAL DESIGN
NOT FOR CONSTRUCTION

DRAWN _____
CHECKED _____
CORRECT _____

SCALE: 0 10 20 30 40m HORIZONTAL
0 5 10m VERTICAL

YONGE SUBWAY EXTENSION
TRACKWORK ALIGNMENT
PLAN AND PROFILE
STA. 3+200 TO STA. 3+900

Plot Date: 11-08-22

TORONTO TRANSIT COMMISSION
ENGINEERING DEPARTMENT

Dwg. No. _____ Sheet No. _____

SHEET 5

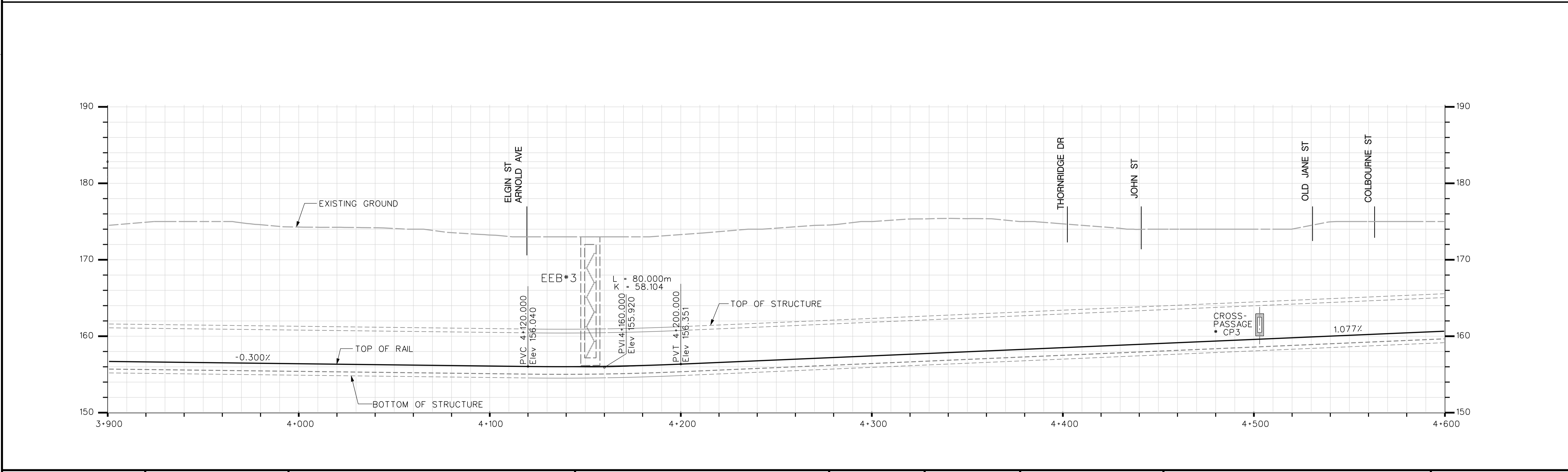

REVISIONS	REVISIONS

CONCEPTUAL DESIGN
NOT FOR CONSTRUCTION

Hatch Mott MacDonald

MRC **MCCORMICK RANKIN CORPORATION**
A member of **MMM GROUP**

DRAWN _____

CHECKED _____

CORRECT _____

SCALE: 0 10 20 30 40m HORIZONTAL

0 5 10m VERTICAL

YONGE SUBWAY EXTENSION

TRACKWORK ALIGNMENT

PLAN AND PROFILE
STA. 3+900 TO STA. 4+600

Plot Date: 11-08-22

TORONTO TRANSIT COMMISSION
ENGINEERING DEPARTMENT

Dwg. No. _____ Sheet No. _____

SHEET 6

DRAWING No.

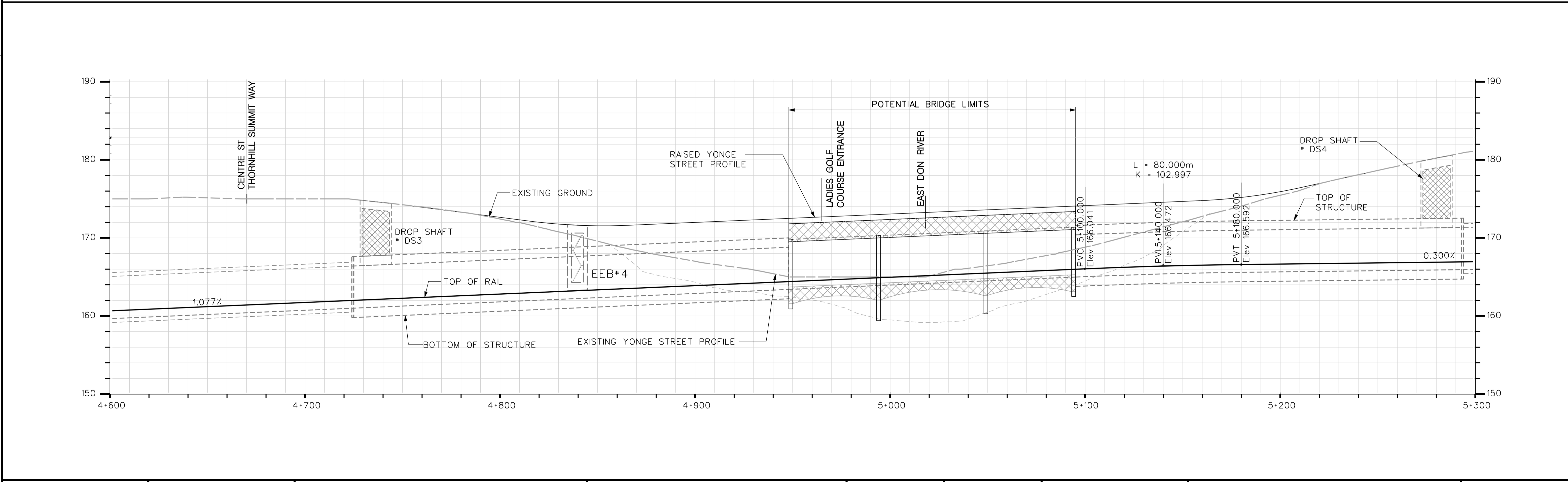
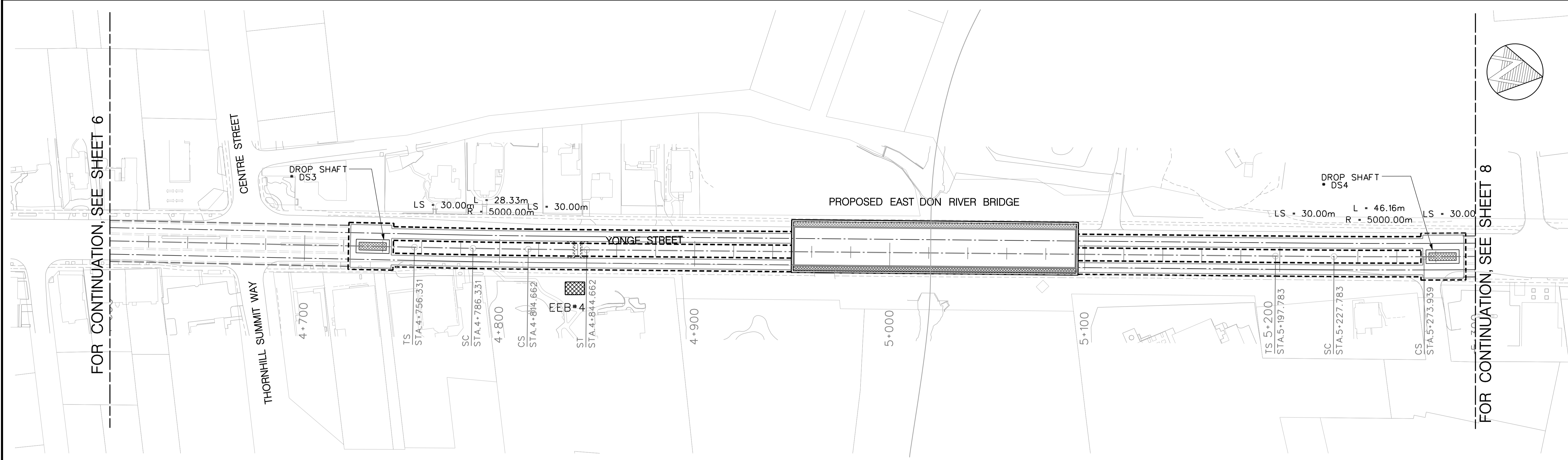
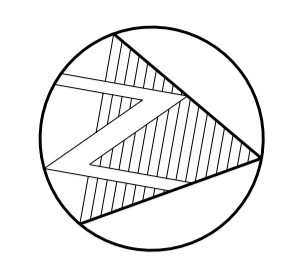

BLDG. REF. No.
FILE
SHEET No.

REVISIONS	REVISIONS

CONCEPTUAL DESIGN
 NOT FOR CONSTRUCTION

Hatch Mott MacDonald

MRC McCORMICK RANKIN CORPORATION
A member of **MMM GROUP**

DRAWN _____

CHECKED _____

CORRECT _____

SCALE: 0 10 20 30 40m HORIZONTAL

0 5 10m VERTICAL

YONGE SUBWAY EXTENSION
TRACKWORK ALIGNMENT
 PLAN AND PROFILE
 STA. 4+600 TO STA. 5+300

Plot Date: 11-08-22

TORONTO TRANSIT COMMISSION
ENGINEERING DEPARTMENT

Dwg. No. _____ Sheet No. _____

SHEET 7

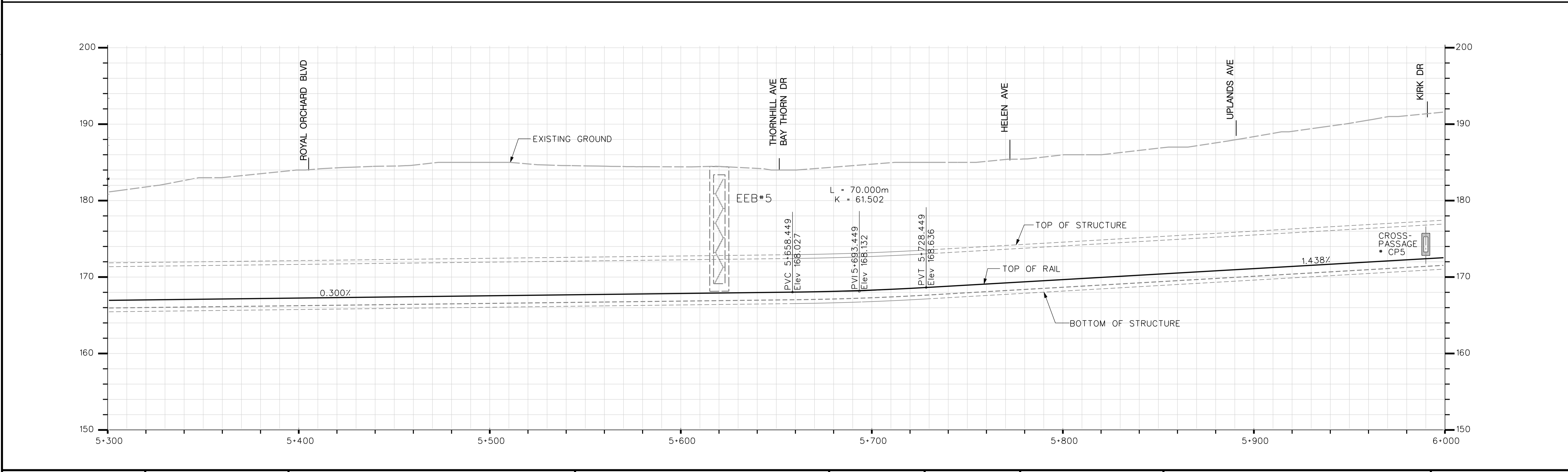
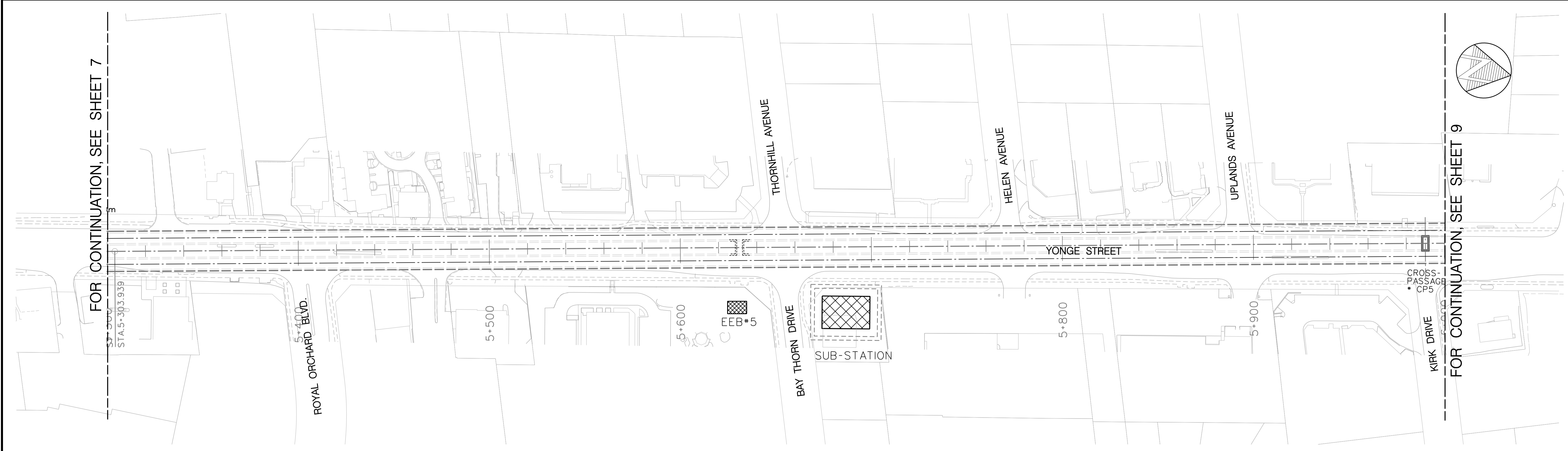

BLDG. REF. No.
FILE
SHEET No.
DRAWING No.

REVISIONS	REVISIONS
△	△
△	△
△	△

CONCEPTUAL DESIGN
 NOT FOR CONSTRUCTION

DRAWN: _____
 CHECKED: _____
 CORRECT: _____

SCALE: 0 10 20 30 40m HORIZONTAL
 0 5 10m VERTICAL

YONGE SUBWAY EXTENSION
TRACKWORK ALIGNMENT
 PLAN AND PROFILE
 STA. 5+300 TO STA. 6+000

Plot Date: 11-08-22

TORONTO TRANSIT COMMISSION
 ENGINEERING DEPARTMENT

Dwg. No. _____ Sheet No. _____

SHEET 8

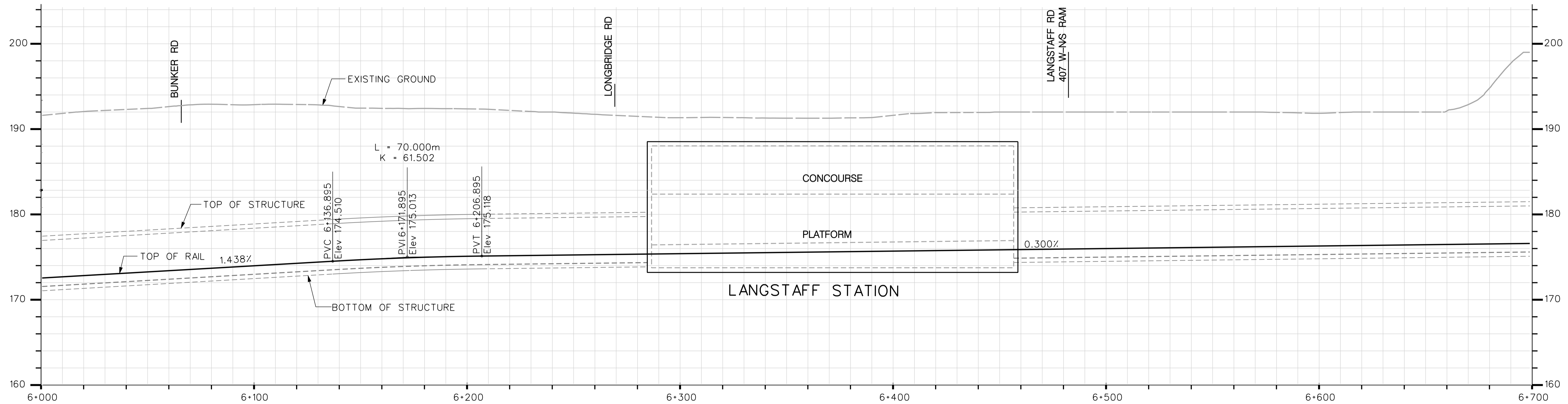
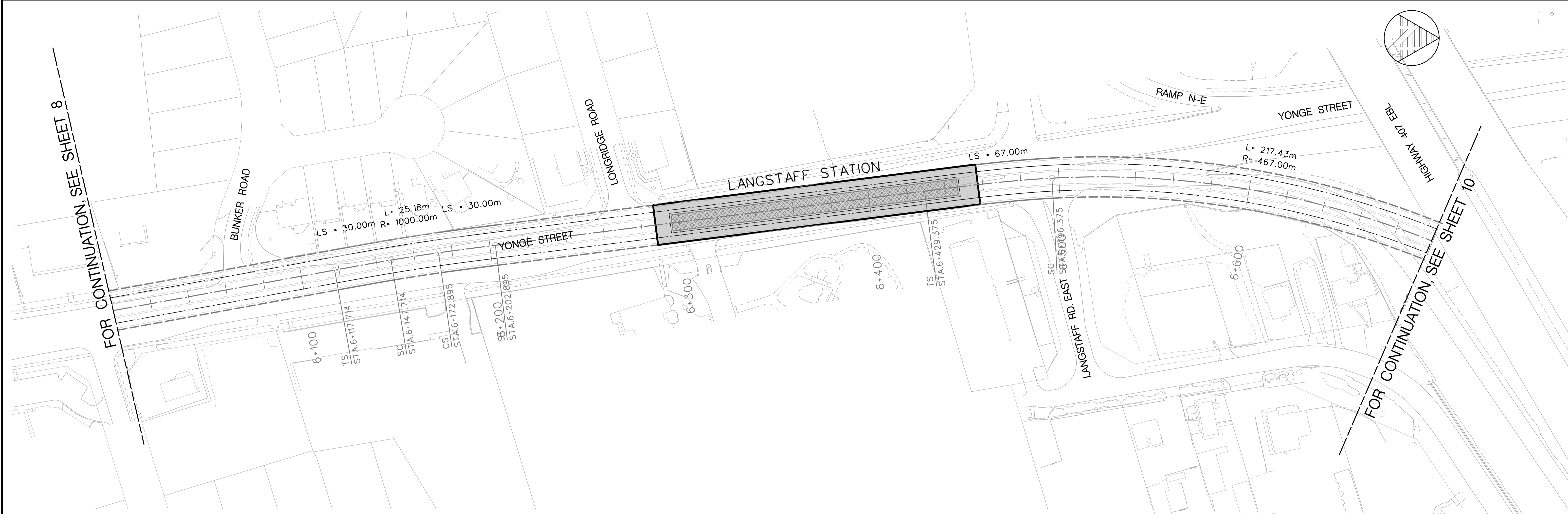

BLDG. REF. No.
FILE
SHEET No.
DRAWING No.

REVISIONS	REVISIONS

CONCEPTUAL DESIGN
NOT FOR CONSTRUCTION

Hatch Mott MacDonald
MCCORMICK RANKIN CORPORATION
A member of **MMM GROUP**

DRAWN _____
CHECKED _____
CORRECT _____

SCALE: 0 10 20 30 40m HORIZONTAL
0 5 10m VERTICAL

YONGE SUBWAY EXTENSION
TRACKWORK ALIGNMENT
PLAN AND PROFILE
STA. 6+000 TO STA. 6+700

Plot Date: 11-08-22

TORONTO TRANSIT COMMISSION
ENGINEERING DEPARTMENT

Dwg. No. _____ Sheet No. _____

SHEET 9

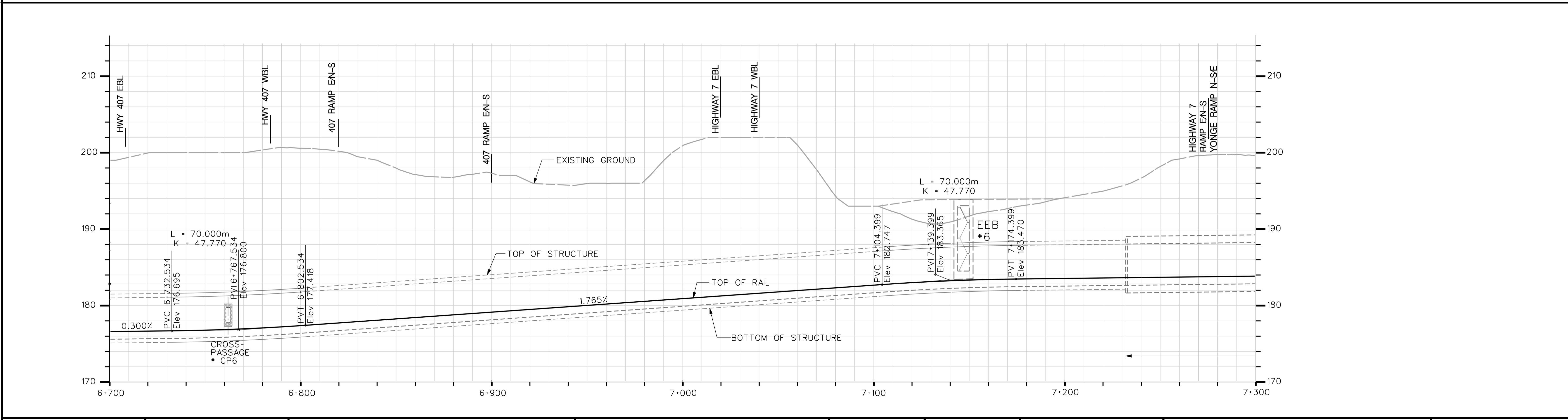
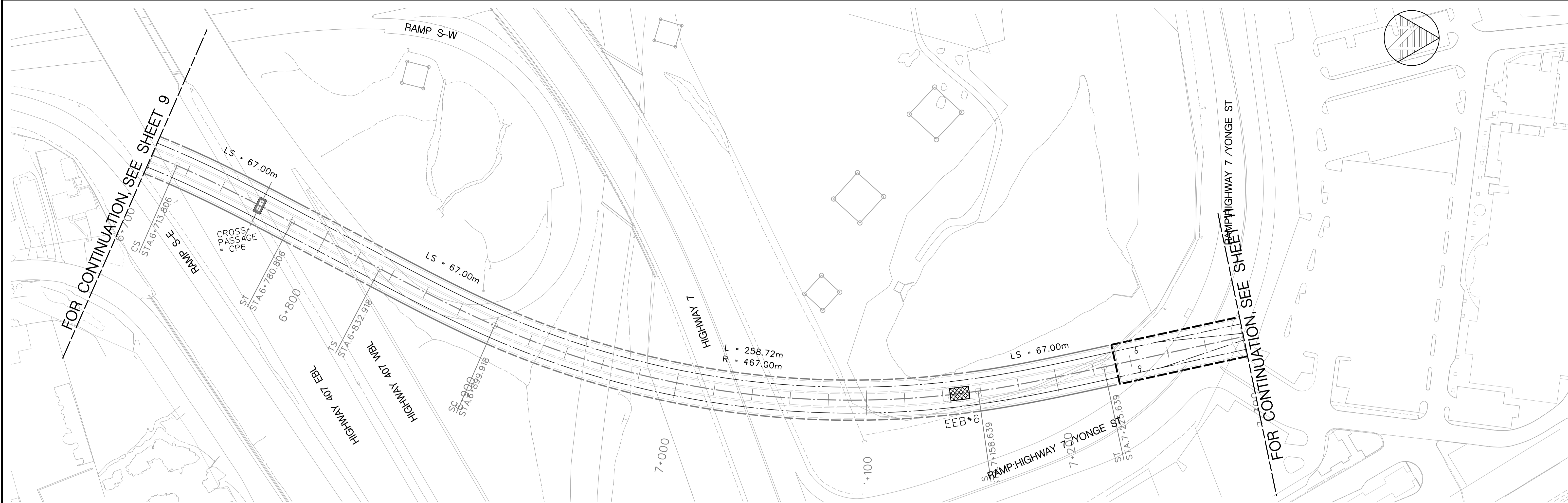

BLDG. REF. No.
FILE
SHEET No.
DRAWING No.

REVISIONS	REVISIONS

CONCEPTUAL DESIGN
NOT FOR CONSTRUCTION

Hatch Mott MacDonald
MCCORMICK RANKIN CORPORATION
A member of **MMM GROUP**

DRAWN _____
CHECKED _____
CORRECT _____

SCALE: 0 10 20 30 40m HORIZONTAL
0 5 10m VERTICAL

YONGE SUBWAY EXTENSION
TRACKWORK ALIGNMENT
PLAN AND PROFILE
STA. 6+700 TO STA. 7+300

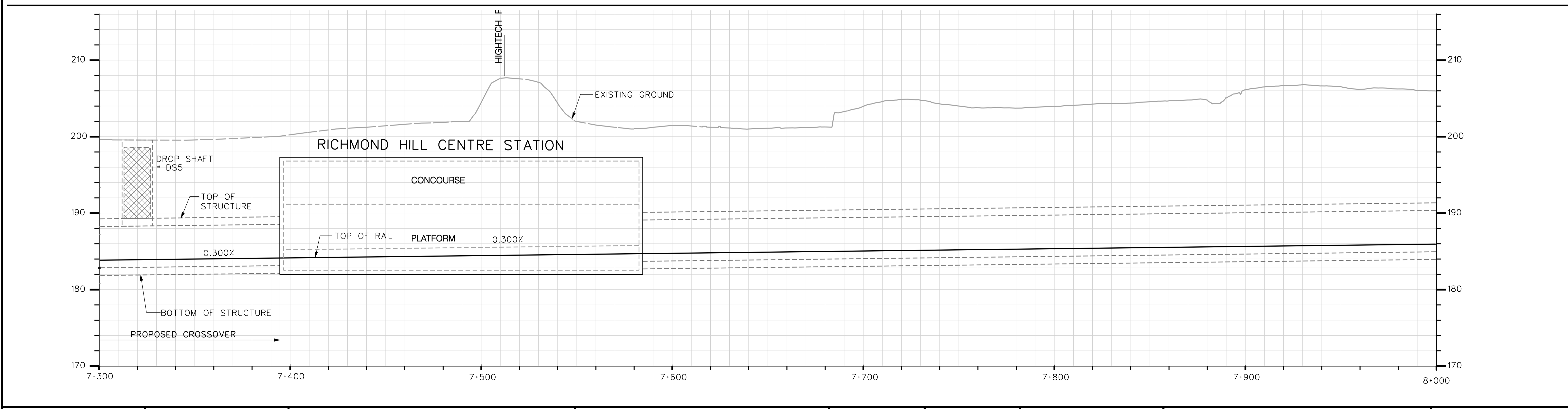
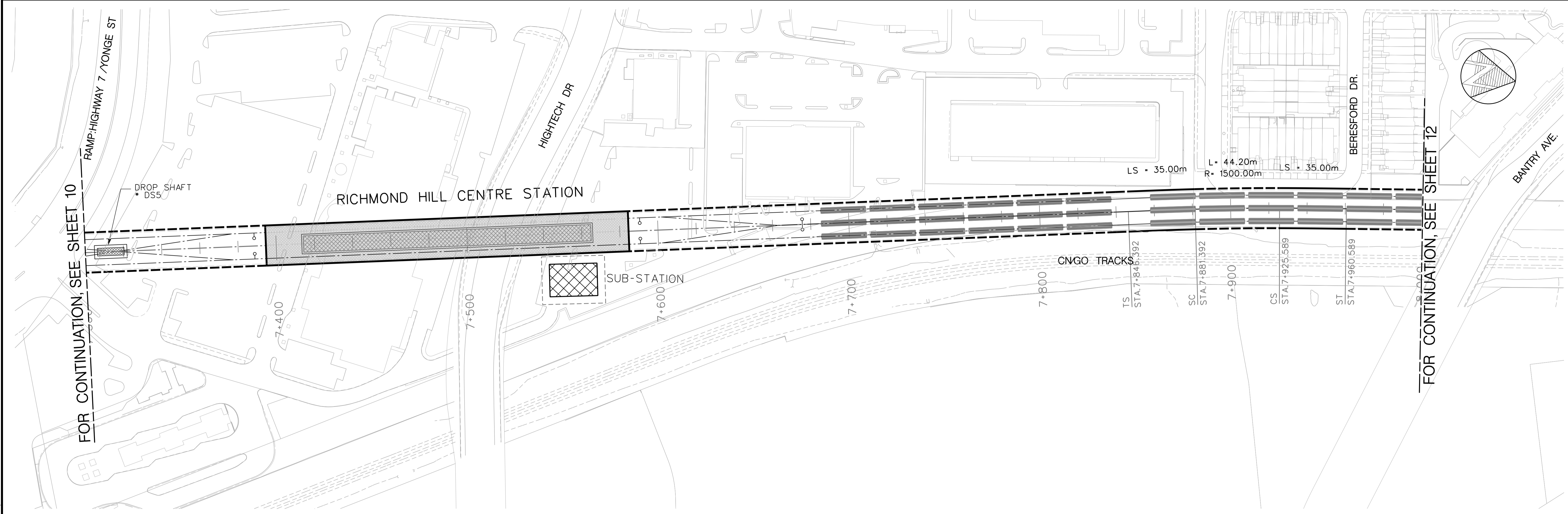

REVISIONS	REVISIONS
△	△
△	△
△	△

CONCEPTUAL DESIGN
NOT FOR CONSTRUCTION

Hatch Mott MacDonald

MRC **MCCORMICK RANKIN CORPORATION**
A member of **MMM GROUP**

DRAWN _____

CHECKED _____

CORRECT _____

SCALE

0 10 20 30 40m HORIZONTAL

0 5 10m VERTICAL

YONGE SUBWAY EXTENSION

TRACKWORK ALIGNMENT

PLAN AND PROFILE
STA. 7+300 TO STA. 8+000

Plot Date: 11-08-22

TORONTO TRANSIT COMMISSION
ENGINEERING DEPARTMENT

Dwg. No. _____ Sheet No. _____

SHEET 11

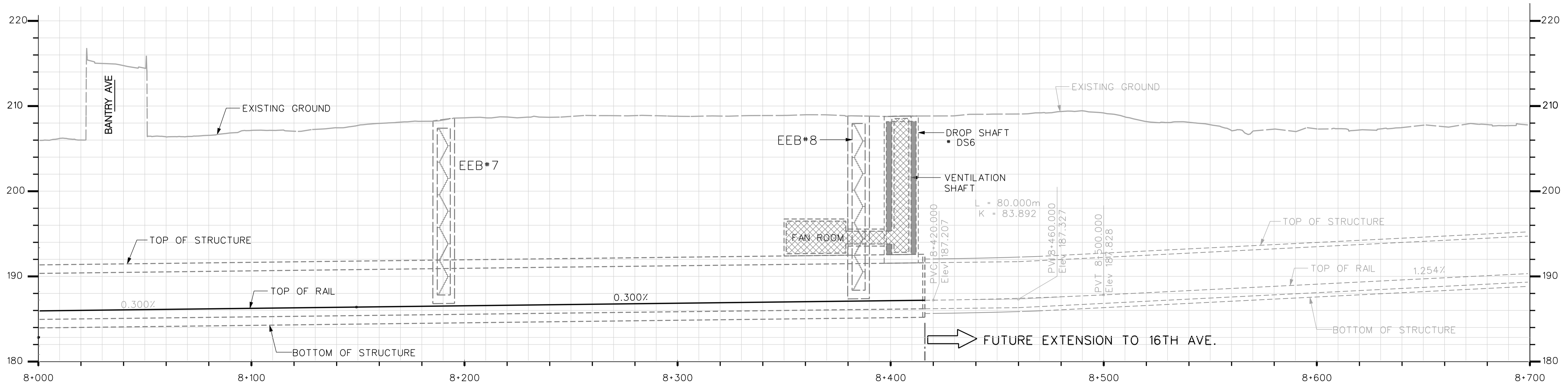
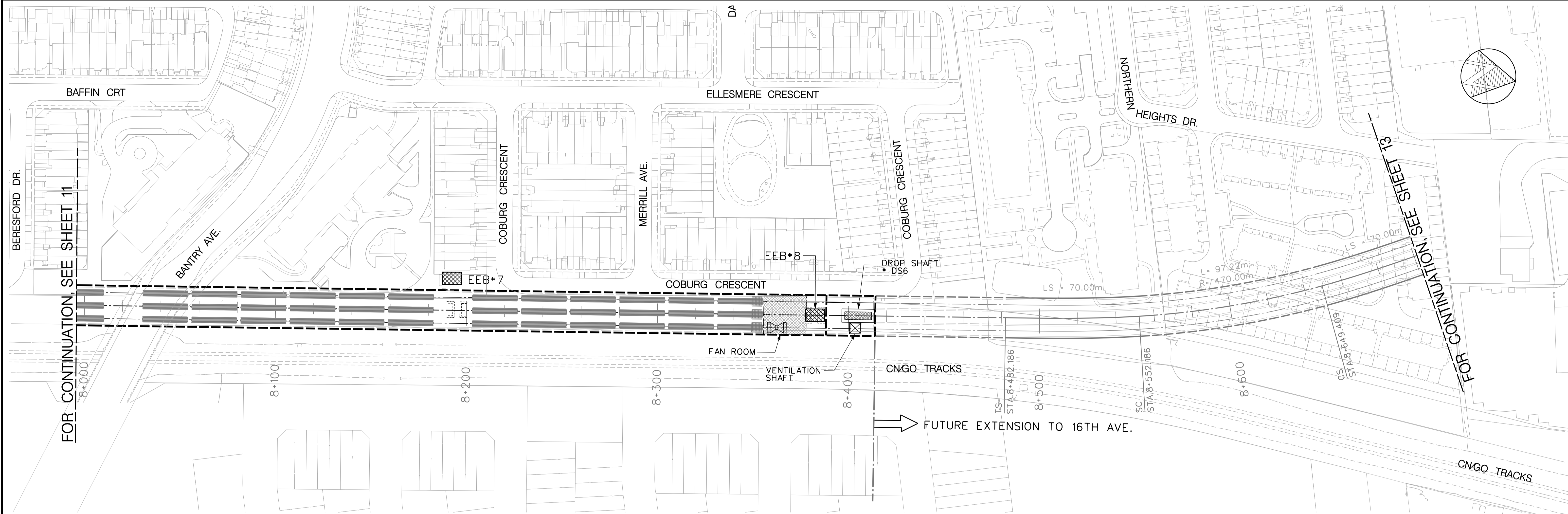

BLDG. REF. No.
FILE
SHEET No.

REVISIONS	REVISIONS

CONCEPTUAL DESIGN
NOT FOR CONSTRUCTION

DRAWN
CHECKED
CORRECT

SCALE: 0 10 20 30 40m HORIZONTAL
0 5 10m VERTICAL

YONGE SUBWAY EXTENSION
TRACKWORK ALIGNMENT
PLAN AND PROFILE
STA. 8+000 TO STA. 8+700

Plot Date: 11-08-22

TORONTO TRANSIT COMMISSION
ENGINEERING DEPARTMENT
Dwg. No. SHEET 12

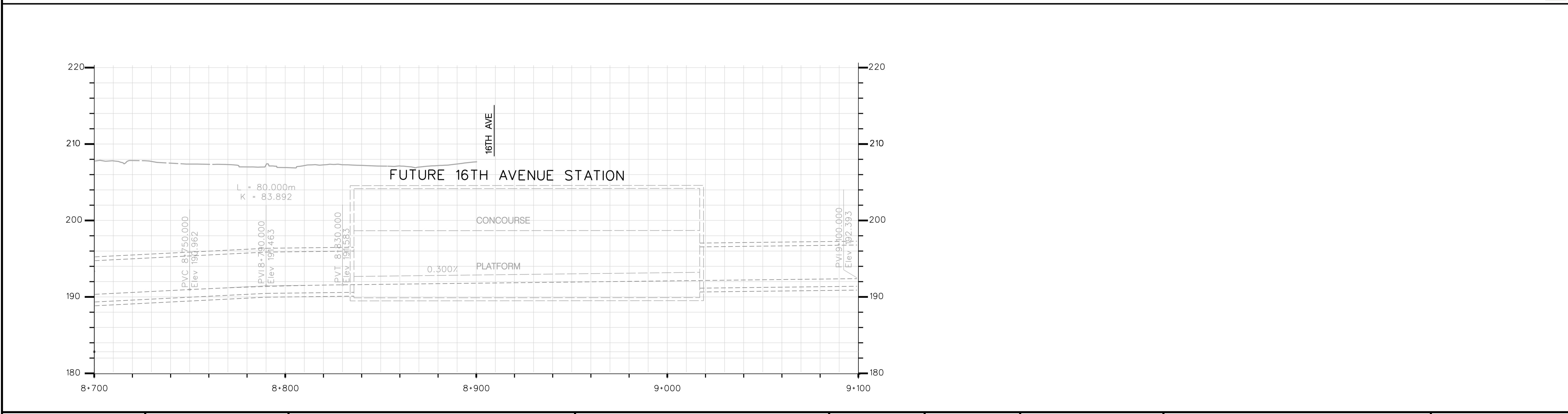
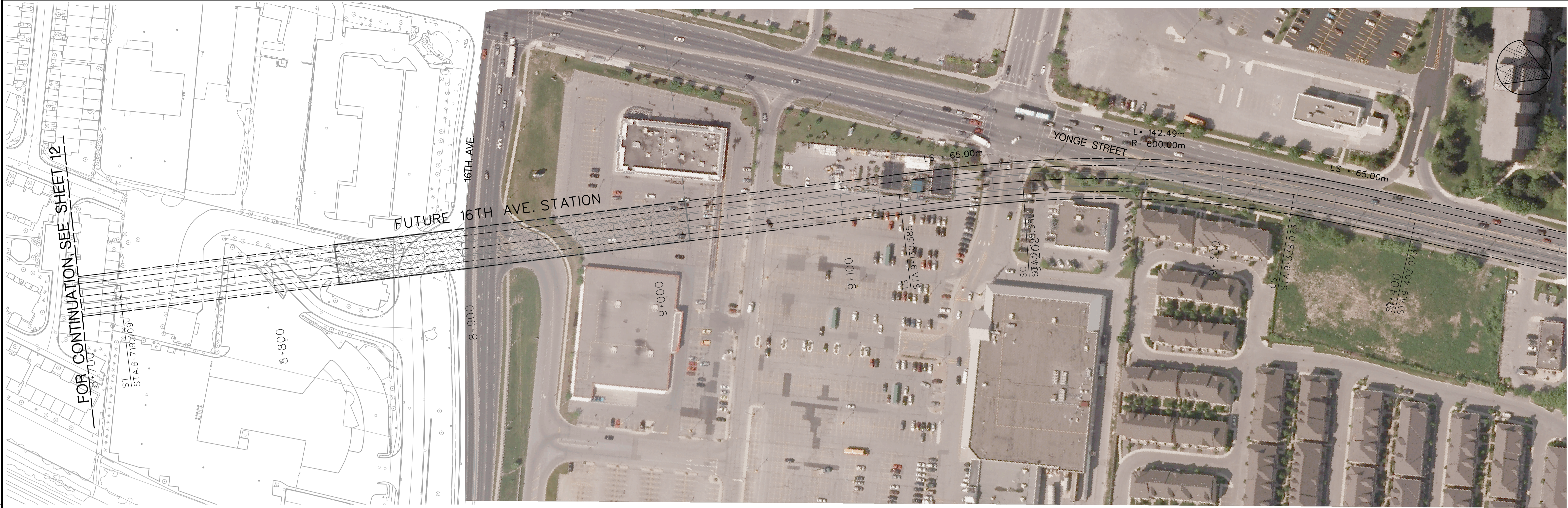

BLDG. REF. No.
FILE
SHEET No.
DRAWING No.

REVISIONS	REVISIONS
△	△
△	△
△	△

CONCEPTUAL DESIGN
NOT FOR CONSTRUCTION

DRAWN _____
CHECKED _____
CORRECT _____

SCALE: 0 10 20 30 40m HORIZONTAL
0 5 10m VERTICAL

YONGE SUBWAY EXTENSION
TRACKWORK ALIGNMENT
PLAN AND PROFILE
STA. 8+700 TO STA. 9+480

Plot Date: 11-08-22

TORONTO TRANSIT COMMISSION
ENGINEERING DEPARTMENT

Dwg. No. _____ Sheet No. _____

SHEET 13

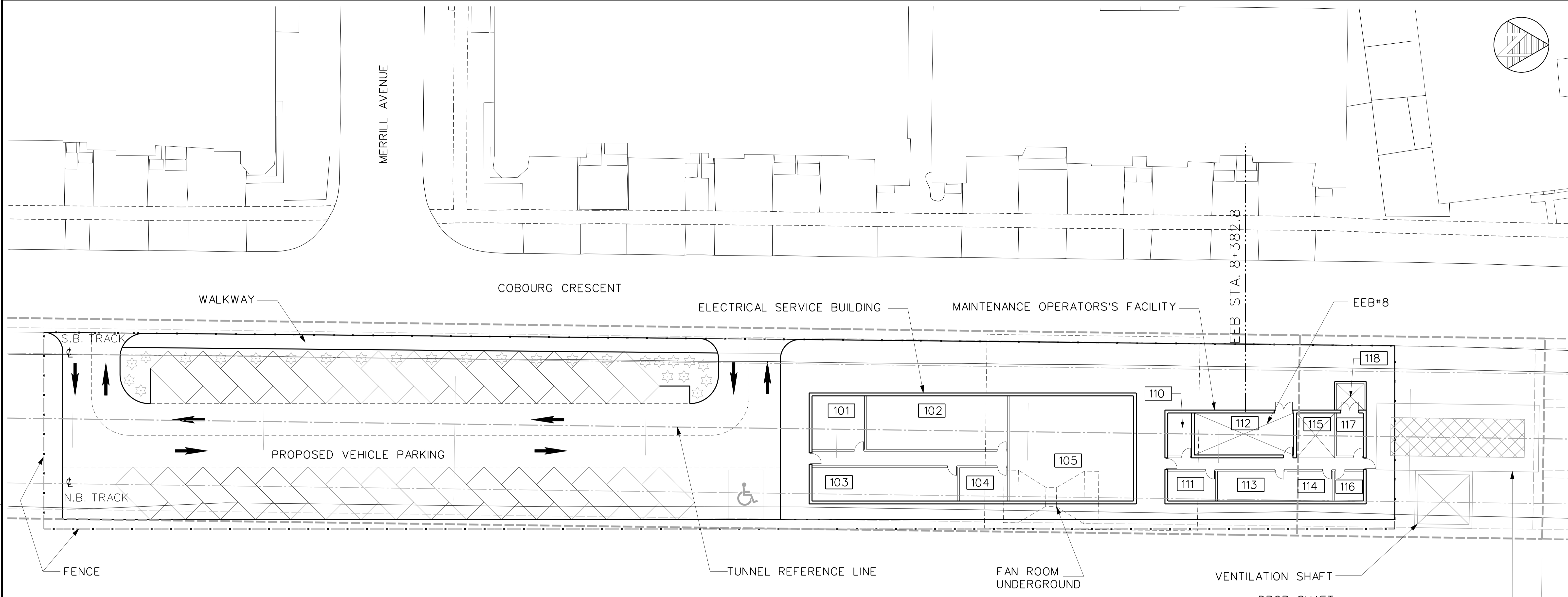
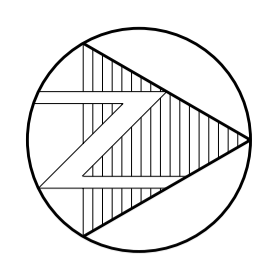

BLDG. REF. No.
FILE
SHEET No.

ROOM LEGEND - ELECTRICAL SERVICE BUILDING		
RM. No.	ROOM NAME	APPROX. RM. AREA
101	HVAC MECHANICAL ROOM	30
102	HIGH VOLTAGE ROOM	70
103	COMMUNICATION ROOM	50
104	EMERGENCY POWER ROOM	15
105	SWITCHGEAR - SWITCHBOARD ROOM	140

ROOM LEGEND - MAINTENANCE OPERATORS'S FACILITY		
RM. No.	ROOM NAME	APPROX. RM. AREA
110	OFFICE	10
111	LUNCH ROOM	15
112	EMERGENCY EXIT STAIR WELL	
113	MEN'S CHANGE ROOM - WASHROOM	20
114	WOMEN'S CHANGE ROOM - WASHROOM	15
115	ELEVATOR	
116	JANITOR CLOSET	5
117	GARBAGE STORAGE	10
118	GARBAGE PICKUP AREA	

CN/GO TRACKS

REVISIONS	REVISIONS

CONCEPTUAL DESIGN
 NOT FOR CONSTRUCTION

DRAWN _____
 CHECKED _____
 CORRECT _____
 SCALE: 8m

YONGE SUBWAY EXTENSION
RICHMOND HILL CENTER STATION TO 16TH AVENUE STATION
 ELECTRICAL SERVICE BUILDING & MAINTENANCE OPERATORS'S FACILITY - SITE PLAN

Plot Date: 11-08-23

 TORONTO TRANSIT COMMISSION
 ENGINEERING DEPARTMENT
 Dwg. No. SK-043 Sheet No.

DRAWING No. SHEET No. FILE BLDG. REF. No.

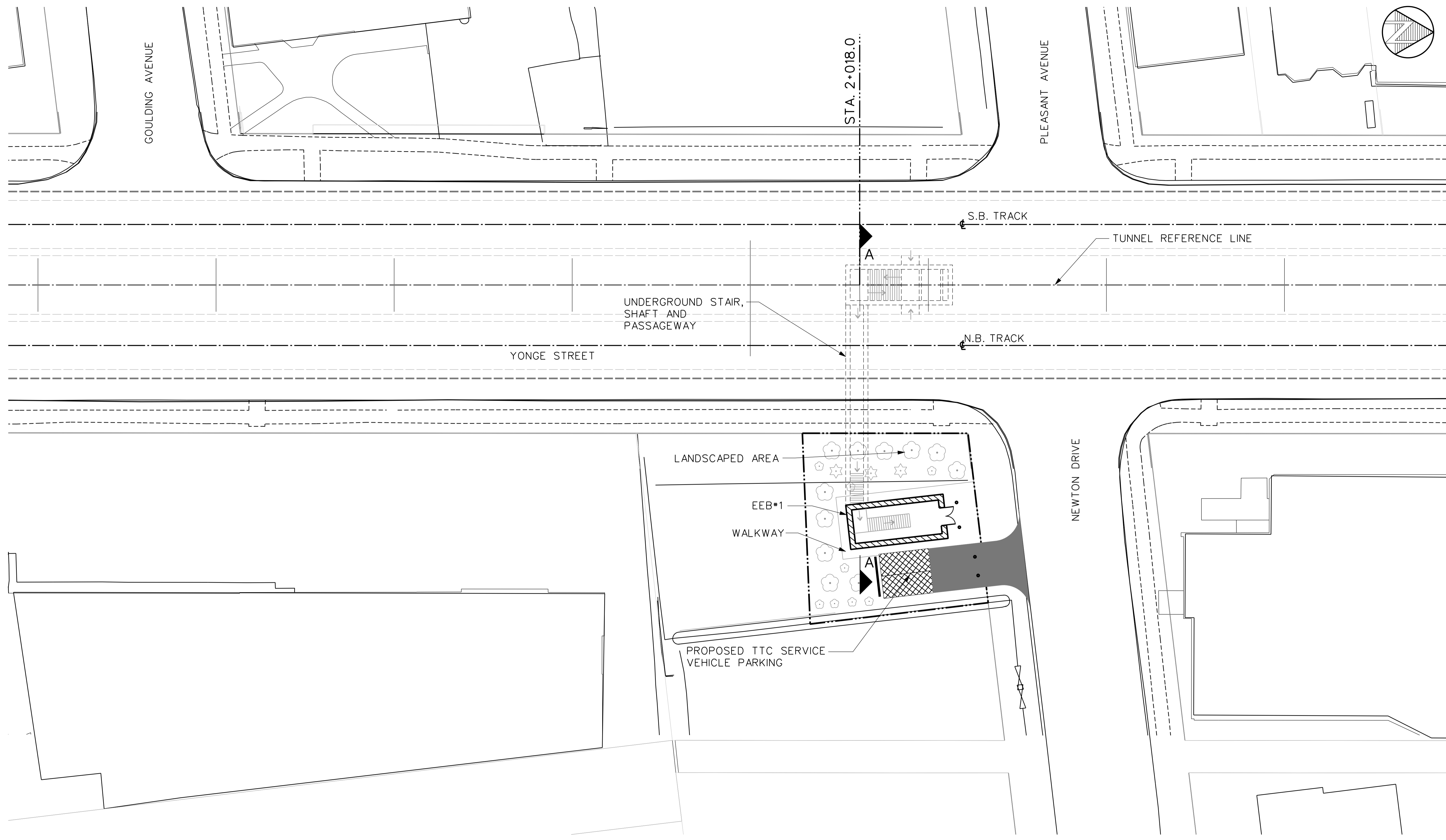

REVISIONS	REVISIONS
△	△
△	△
△	△

CONCEPTUAL DESIGN
 NOT FOR CONSTRUCTION

Hatch Mott MacDonald

McCORMICK RANKIN CORPORATION

A member of **MMM GROUP**

DRAWN
CHECKED
CORRECT
SCALE

YONGE SUBWAY EXTENSION
CUMMER STN. TO STEELES STN.
 EMERGENCY EXIT BUILDING NO. 1
 SITE PLAN

Plot Date: 11-08-23
TORONTO TRANSIT COMMISSION ENGINEERING DEPARTMENT
Dwg. No. SK-055
Sheet No.

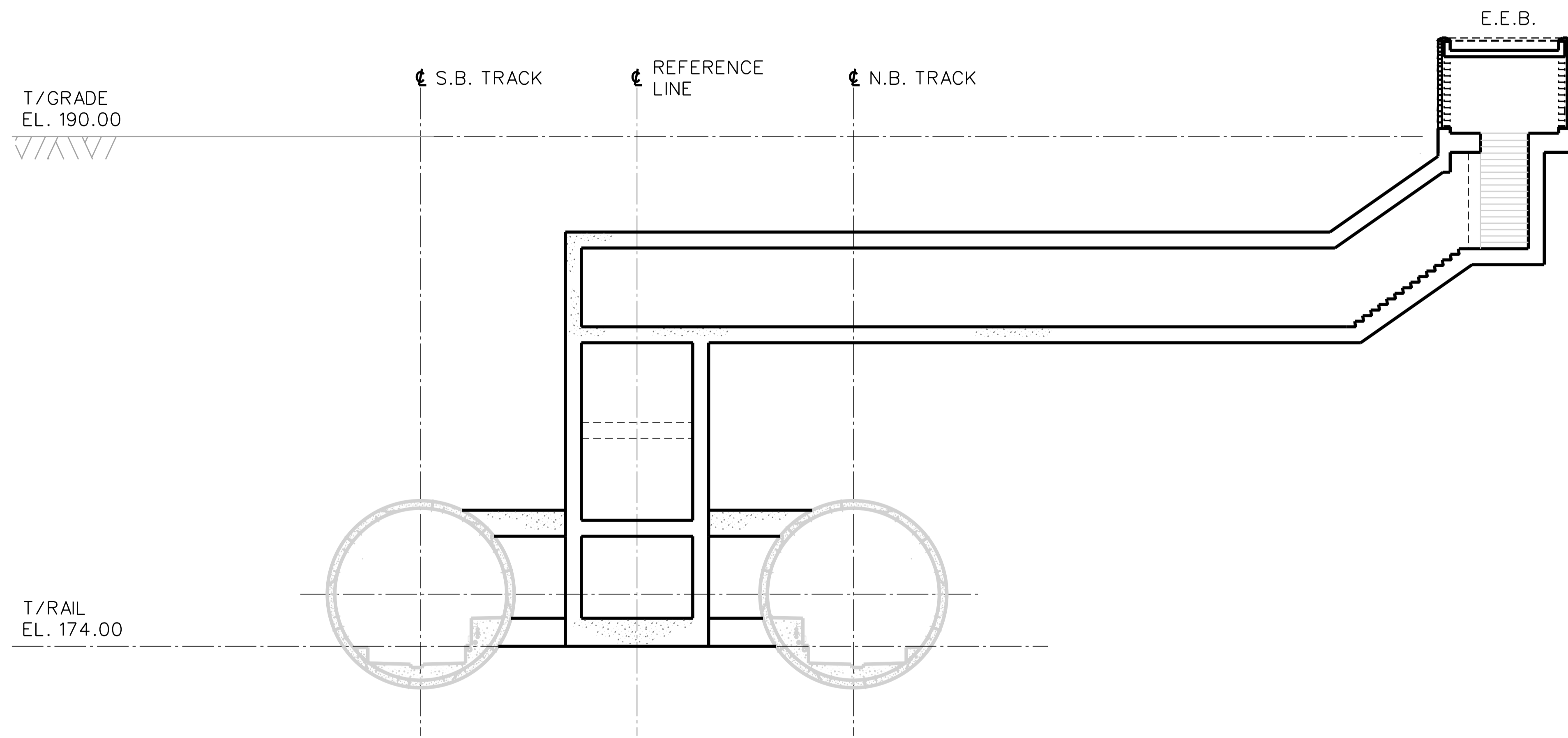

SECTION A-A THROUGH EEB #1
SCALE 1:200

BLDG. REF. No.
FILE
SHEET No.

REVISIONS	REVISIONS
△	△
△	△
△	△

CONCEPTUAL DESIGN
 NOT FOR CONSTRUCTION

Hatch Mott MacDonald

McCORMICK RANKIN CORPORATION
A member of **MMM GROUP**

DRAWN

CHECKED

CORRECT

SCALE

YONGE SUBWAY EXTENSION

CUMMER STN. TO STEELES STN.

EMERGENCY EXIT BUILDING NO. 1
SECTION

Plot Date: 11-08-22

TORONTO TRANSIT COMMISSION
ENGINEERING DEPARTMENT

Dwg. No. **SK-056** Sheet No. _____

DRAWING No.

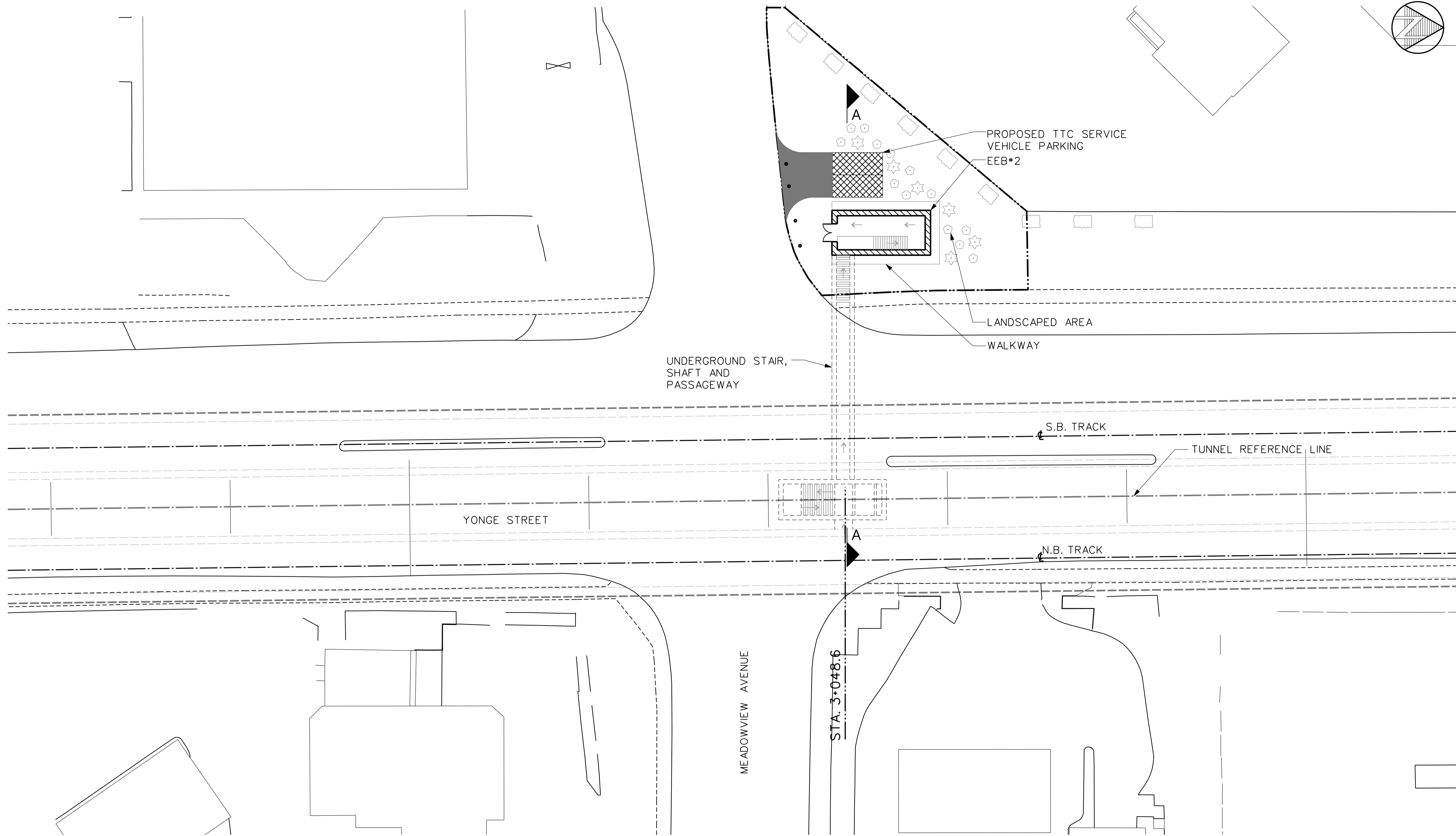
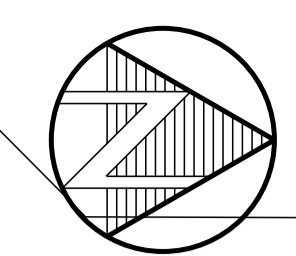

BLDG. REF. No.
 FILE
 SHEET No.
 DRAWING No.

REVISIONS	REVISIONS
△	△
△	△
△	△

CONCEPTUAL DESIGN
 NOT FOR CONSTRUCTION

Hatch Mott MacDonald
MCCORMICK RANKIN CORPORATION
 A member of **MMM GROUP**

DRAWN
 CHECKED
 CORRECT
 SCALE

YONGE SUBWAY EXTENSION
STEELES STN. TO CLARK STN.
 EMERGENCY EXIT BUILDING NO. 2
 SITE PLAN

Plot Date: 11-08-23

TORONTO TRANSIT COMMISSION
 ENGINEERING DEPARTMENT
 Dwg. No. SK-057 Sheet No.

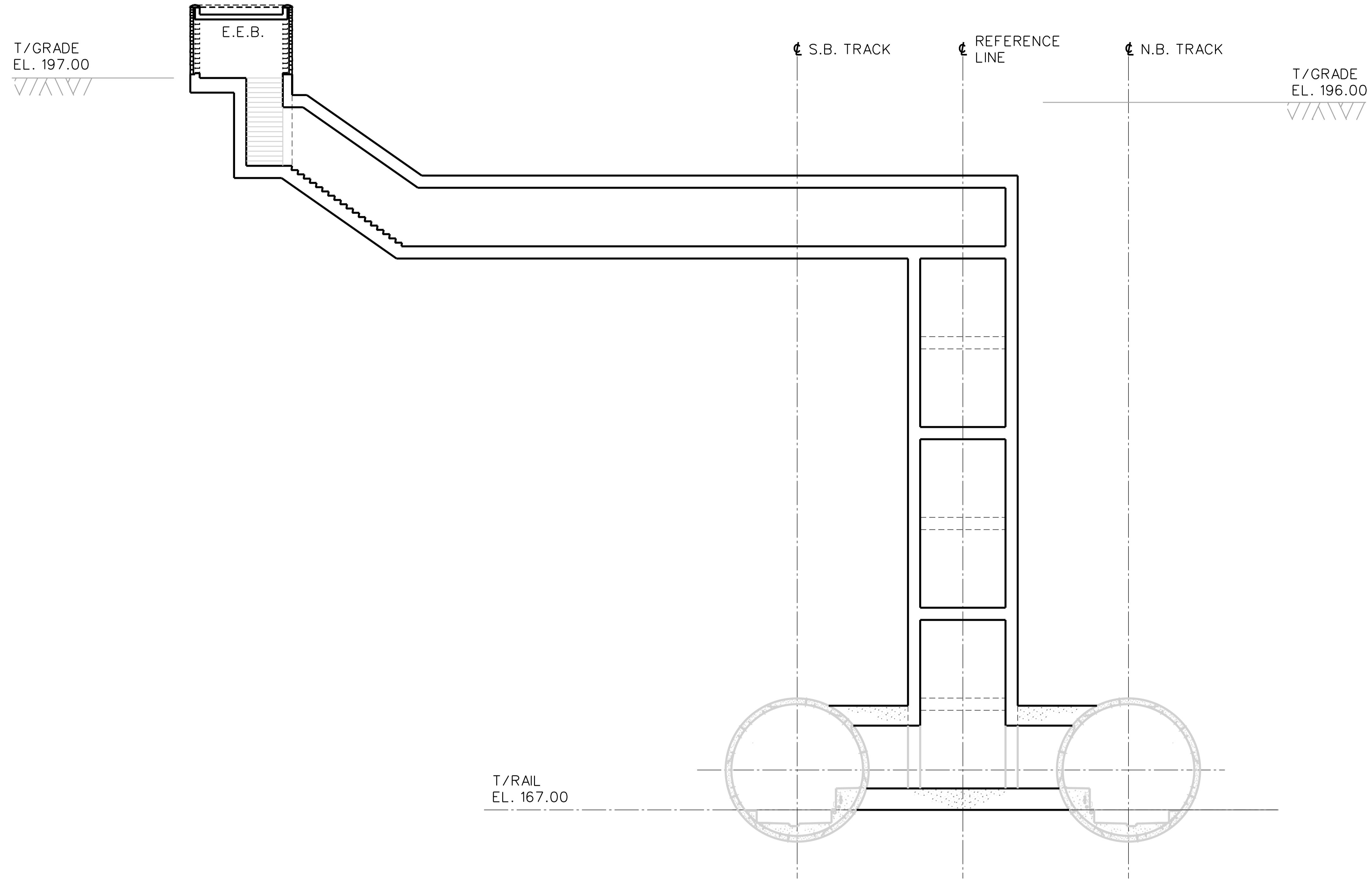

SECTION A-A THROUGH EEB #2
SCALE 1:200

BLDG. REF. No.
FILE
SHEET No.

REVISIONS	REVISIONS
△	△
△	△
△	△

CONCEPTUAL DESIGN
 NOT FOR CONSTRUCTION

DRAWN
 CHECKED
 CORRECT
 SCALE

YONGE SUBWAY EXTENSION
STEELES STN. TO CLARK STN.
 EMERGENCY EXIT BUILDING NO. 2
 SECTION

Plot Date: 11-08-23

 TORONTO TRANSIT COMMISSION
 ENGINEERING DEPARTMENT
 Dwg. No. SK-058 Sheet No.

DRAWING No.

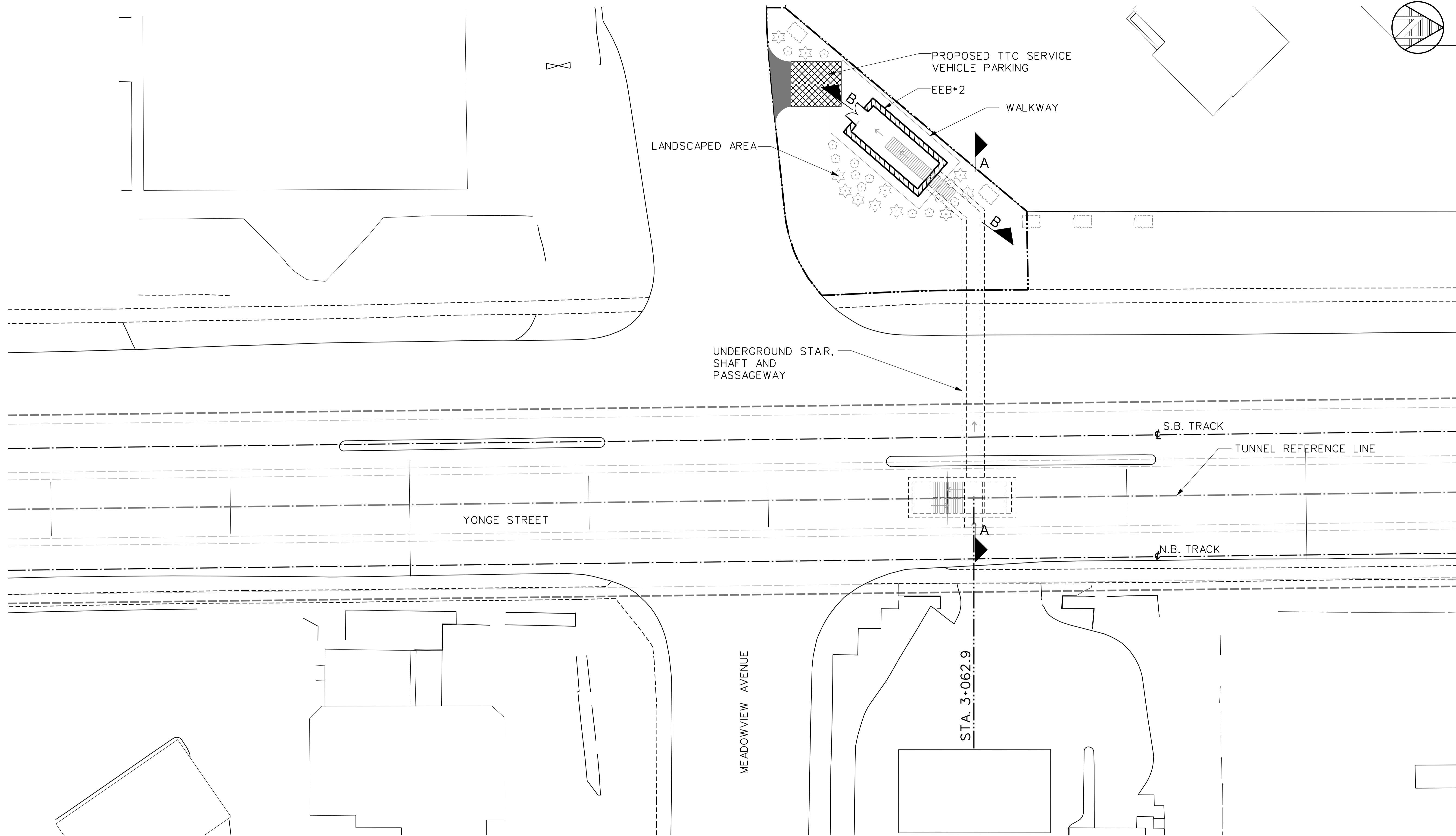
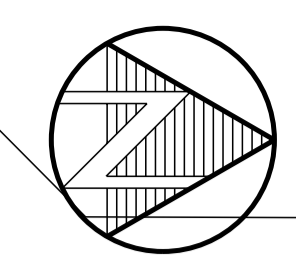

DRAWING No. SHEET No. FILE BLDG. REF. No.

REVISIONS	REVISIONS

CONCEPTUAL DESIGN
 NOT FOR CONSTRUCTION

Hatch Mott MacDonald
MRC **MCCORMICK RANKIN CORPORATION**
 A member of **MMM GROUP**

DRAWN
 CHECKED
 CORRECT
 SCALE: 8m

YONGE SUBWAY EXTENSION
STEELES STN. TO CLARK STN.
 EMERGENCY EXIT BUILDING NO. 2
 SITE PLAN (OPTION 1)

Plot Date: 11-08-23

TORONTO TRANSIT COMMISSION
 ENGINEERING DEPARTMENT
 Dwg. No. **SK-059** Sheet No.

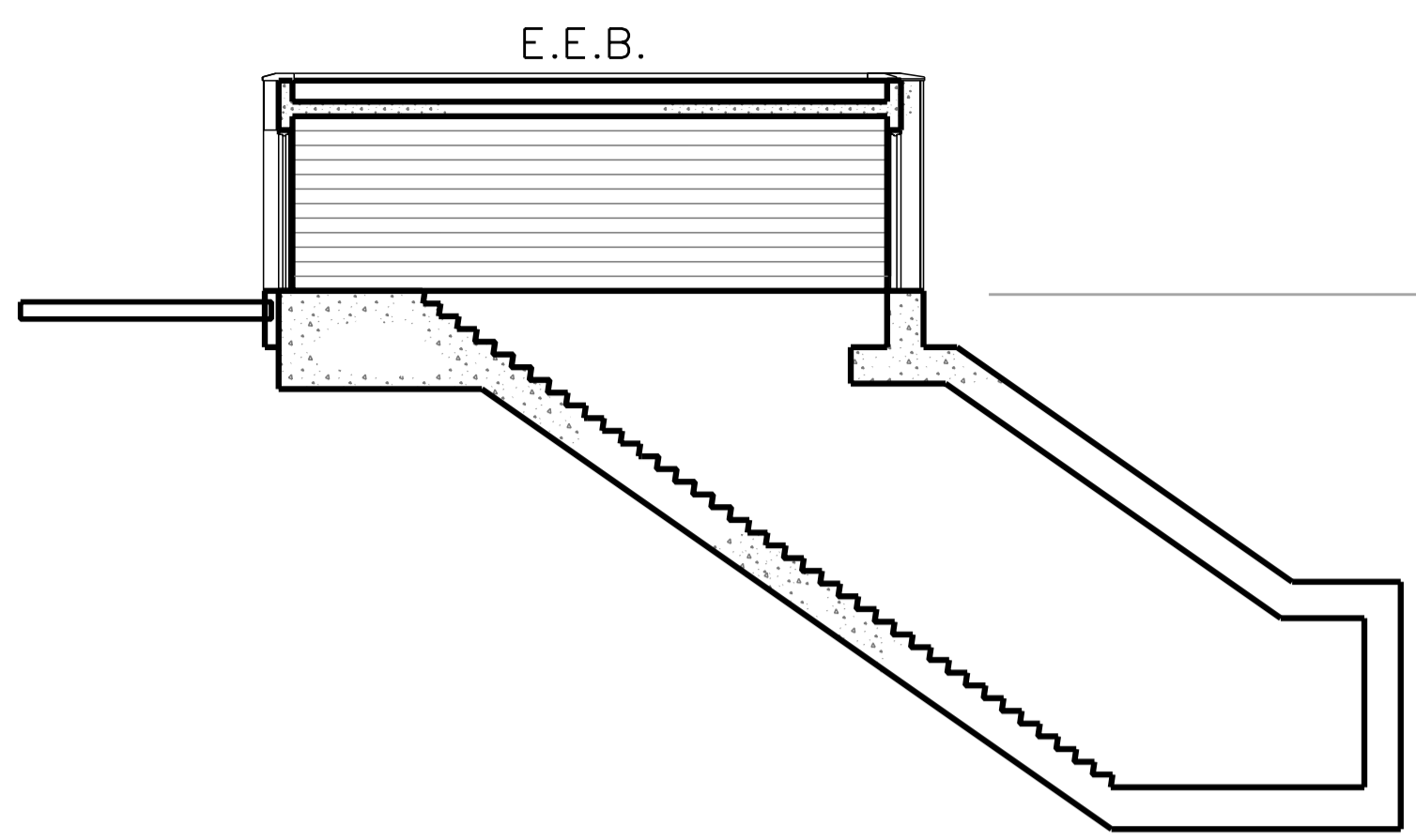

SECTION B-B THROUGH EEB #2
SCALE 1:200

T/GRADE
EL. 197.00
▽▽▽▽

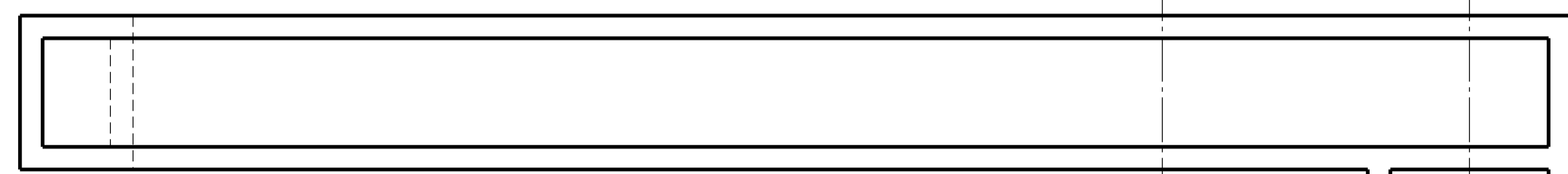

¢ S.B. TRACK ¢ REFERENCE LINE ¢ N.B. TRACK

T/GRADE
EL. 196.00
▽▽▽▽

T/RAIL
EL. 167.00

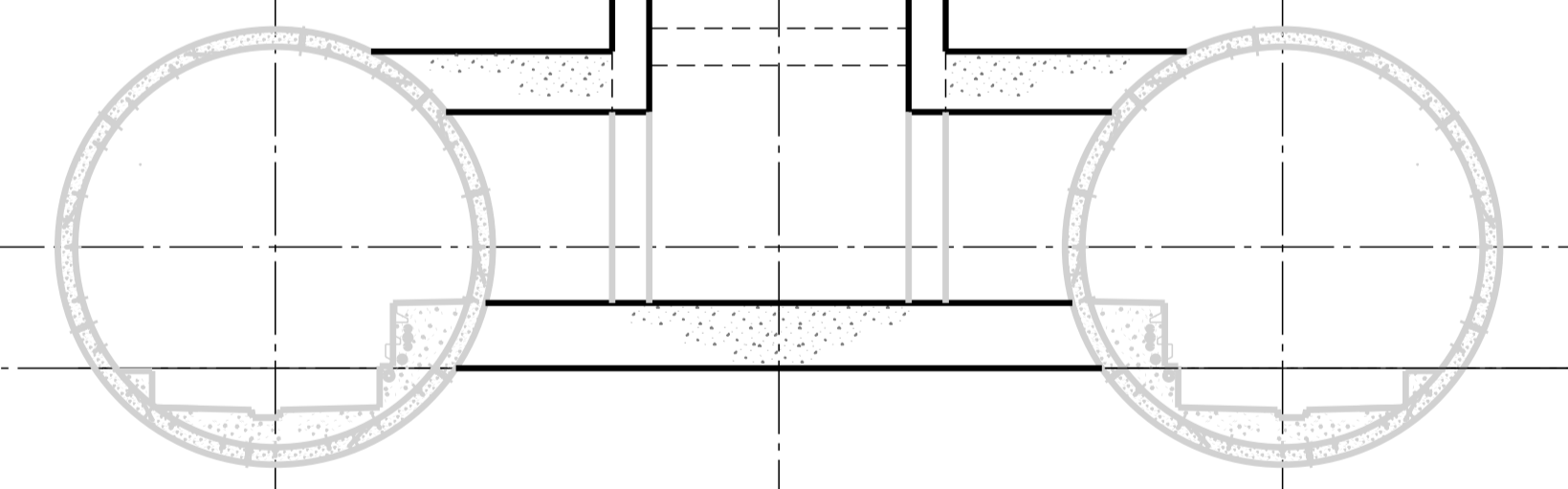

SECTION A-A THROUGH EEB #2
SCALE 1:200

BLDG. REF. No.

FILE

SHEET No.

DRAWING No.

REVISIONS	REVISIONS
△	△
△	△
△	△

**CONCEPTUAL
DESIGN**
 NOT FOR CONSTRUCTION

DRAWN

CHECKED

CORRECT

SCALE

YONGE SUBWAY EXTENSION
STEELES STN. TO CLARK STN.
 EMERGENCY EXIT BUILDING NO. 2
 SECTION (OPTION 1)

Plot Date: 11-08-23

TORONTO TRANSIT COMMISSION
 ENGINEERING DEPARTMENT

Dwg. No. **SK-060** Sheet No. _____

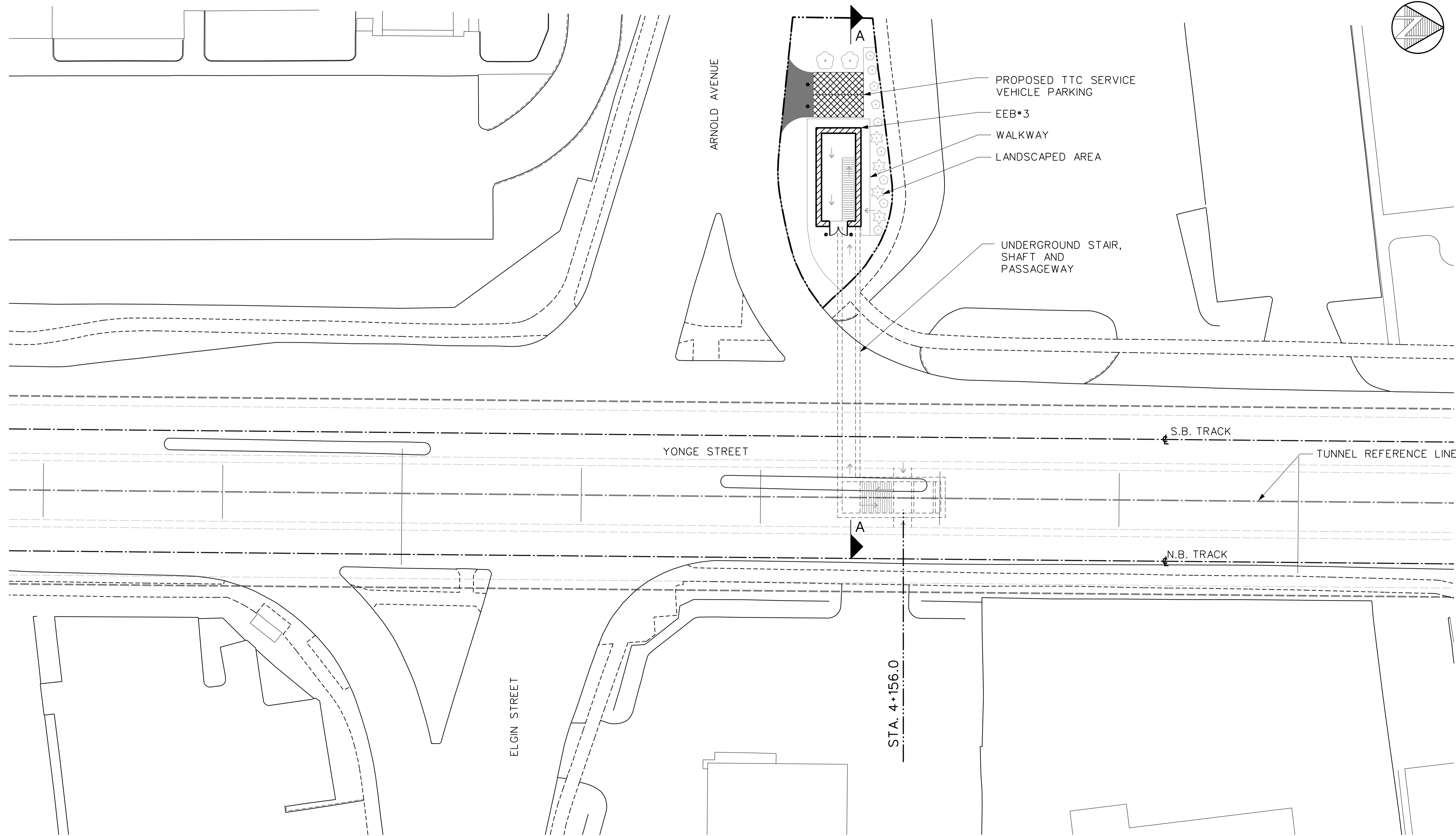
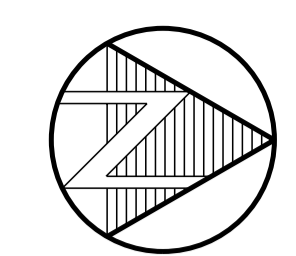

DRAWING No. SHEET No. FILE BLDG. REF. No.

REVISIONS	REVISIONS
△	△
△	△
△	△

**CONCEPTUAL
DESIGN**
NOT FOR CONSTRUCTION

**Hatch Mott
MacDonald**
MRC **MCCORMICK RANKIN
CORPORATION**
A member of **MMM GROUP**

DRAWN
CHECKED
CORRECT

SCALE
0 1 2 3 4 5 8m

YONGE SUBWAY EXTENSION
CLARK STN. TO LANGSTAFF STN.
EMERGENCY EXIT BUILDING NO. 3
SITE PLAN

Plot Date: 11-08-23

TORONTO TRANSIT COMMISSION
ENGINEERING DEPARTMENT

Dwg. No. **SK-061** Sheet No. _____

DRAWING No. SHEET No. FILE BLDG. REF. No.

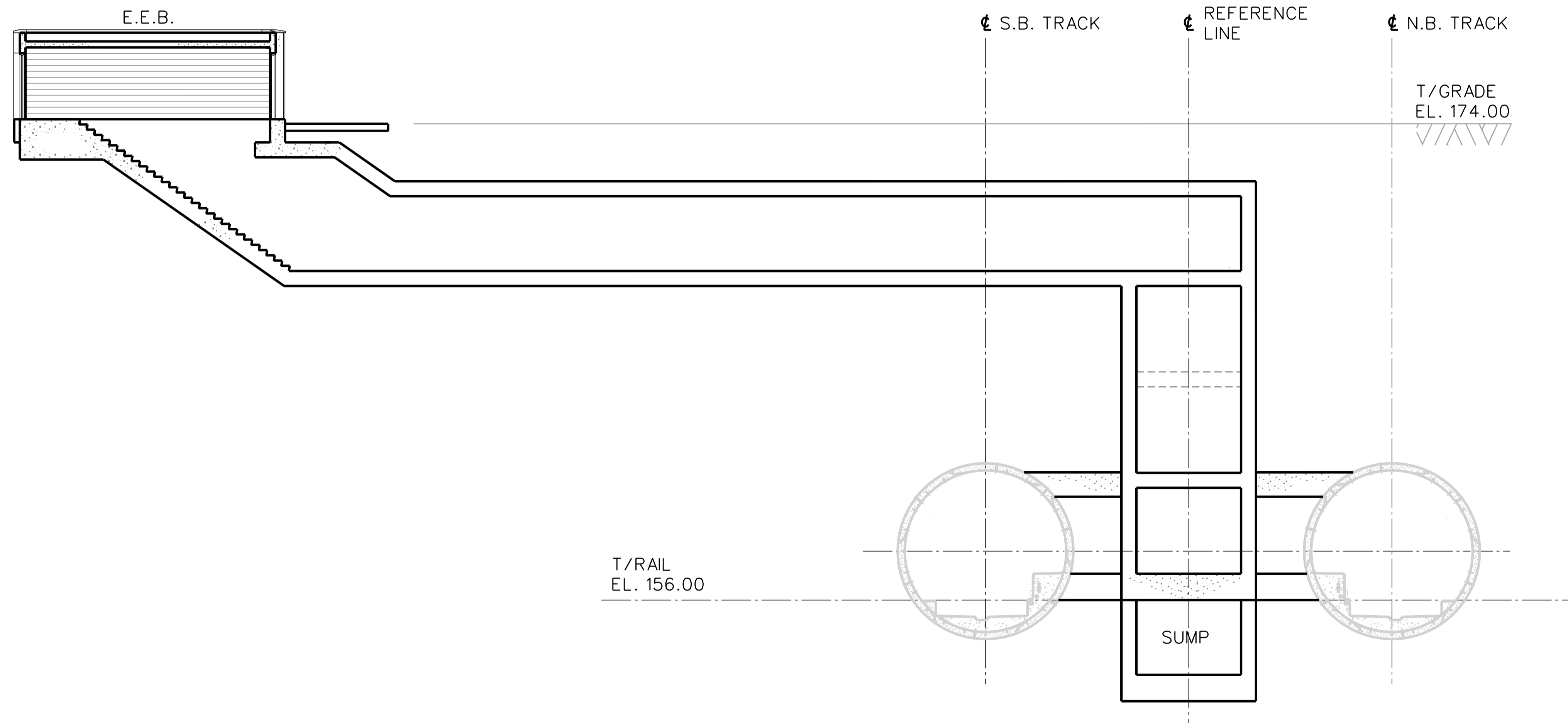

SECTION A-A THROUGH EEB #3
SCALE 1:200

REVISIONS	REVISIONS
△	△
△	△
△	△

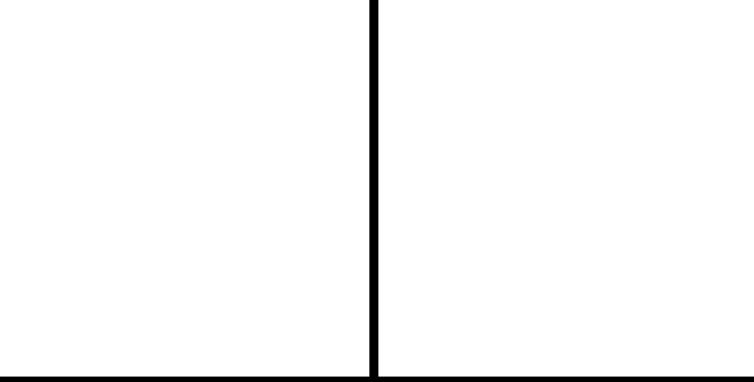

DRAWN
CHECKED
CORRECT

SCALE
0 1 2 3 4m

YONGE SUBWAY EXTENSION
CLARK STN. TO LANGSTAFF STN.
EMERGENCY EXIT BUILDING NO. 3
SECTION

Plot Date: 11-08-23

TORONTO TRANSIT COMMISSION
ENGINEERING DEPARTMENT

Dwg. No. SK-062 Sheet No.

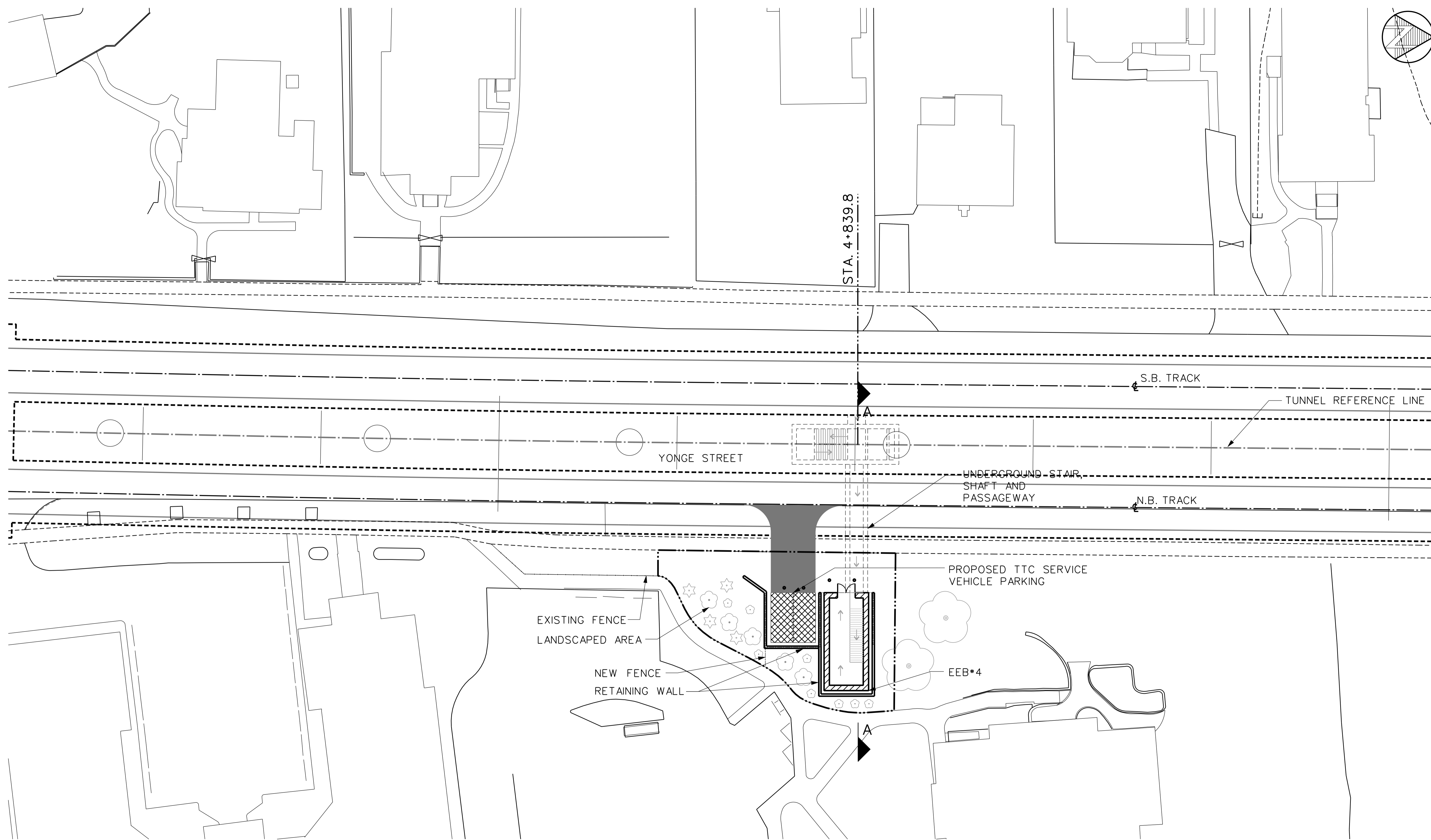

BLDG. REF. No.
FILE
SHEET No.

REVISIONS	REVISIONS
△	△
△	△
△	△

CONCEPTUAL DESIGN
 NOT FOR CONSTRUCTION

Hatch Mott MacDonald

McCORMICK RANKIN CORPORATION
A member of **MMM GROUP**

DRAWN
 CHECKED
 CORRECT
 SCALE

YONGE SUBWAY EXTENSION
CLARK STN. TO LANGSTAFF STN.
 EMERGENCY EXIT BUILDING NO. 4
 SITE PLAN

Plot Date: 11-08-23

TORONTO TRANSIT COMMISSION
 ENGINEERING DEPARTMENT
 Dwg. No. SK-063 Sheet No.

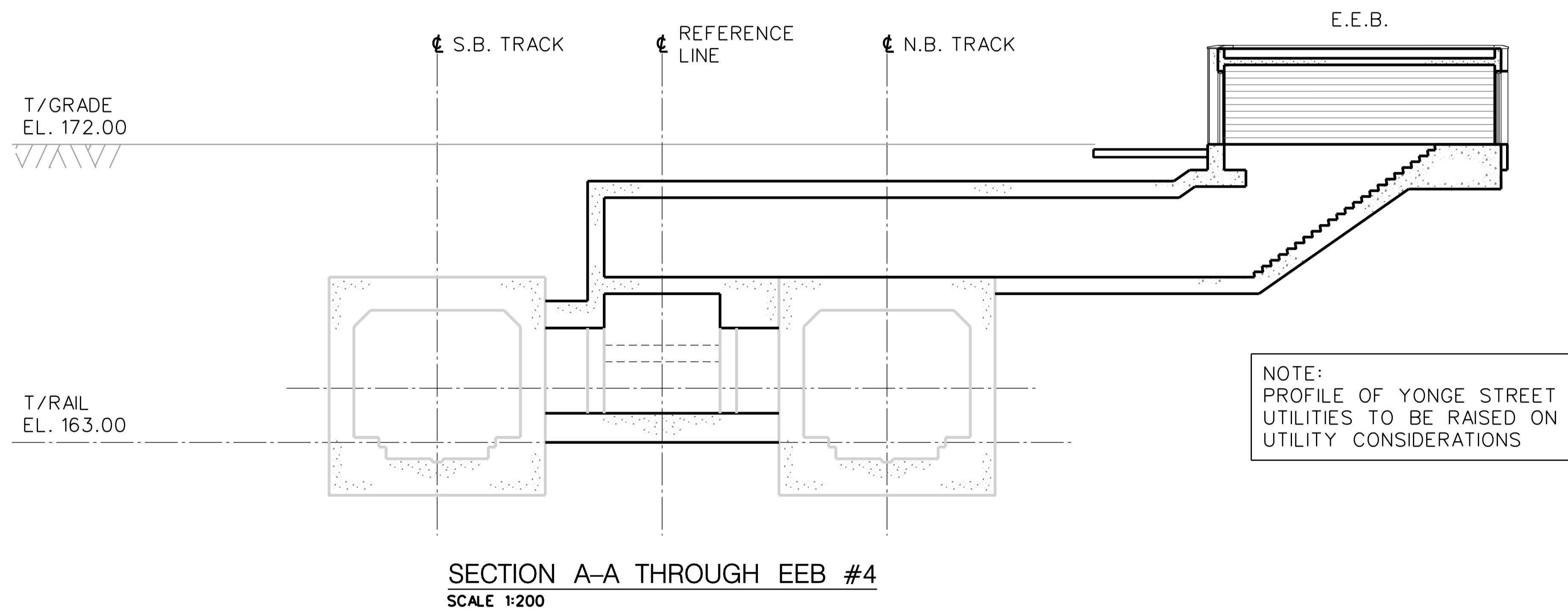

BLDG. REF. No.
FILE
SHEET No.

REVISIONS	REVISIONS
△	△
△	△
△	△

CONCEPTUAL DESIGN
 NOT FOR CONSTRUCTION

Hatch Mott MacDonald

McCORMICK RANKIN CORPORATION
A member of **MMM GROUP**

DRAWN
 CHECKED
 CORRECT
 SCALE

YONGE SUBWAY EXTENSION
CLARK STN. TO LANGSTAFF STN.
 EMERGENCY EXIT BUILDING NO. 4
 SECTION

Plot Date: 11-08-23

TORONTO TRANSIT COMMISSION
 ENGINEERING DEPARTMENT
 Dwg. No. **SK-064** Sheet No.

DRAWING No.

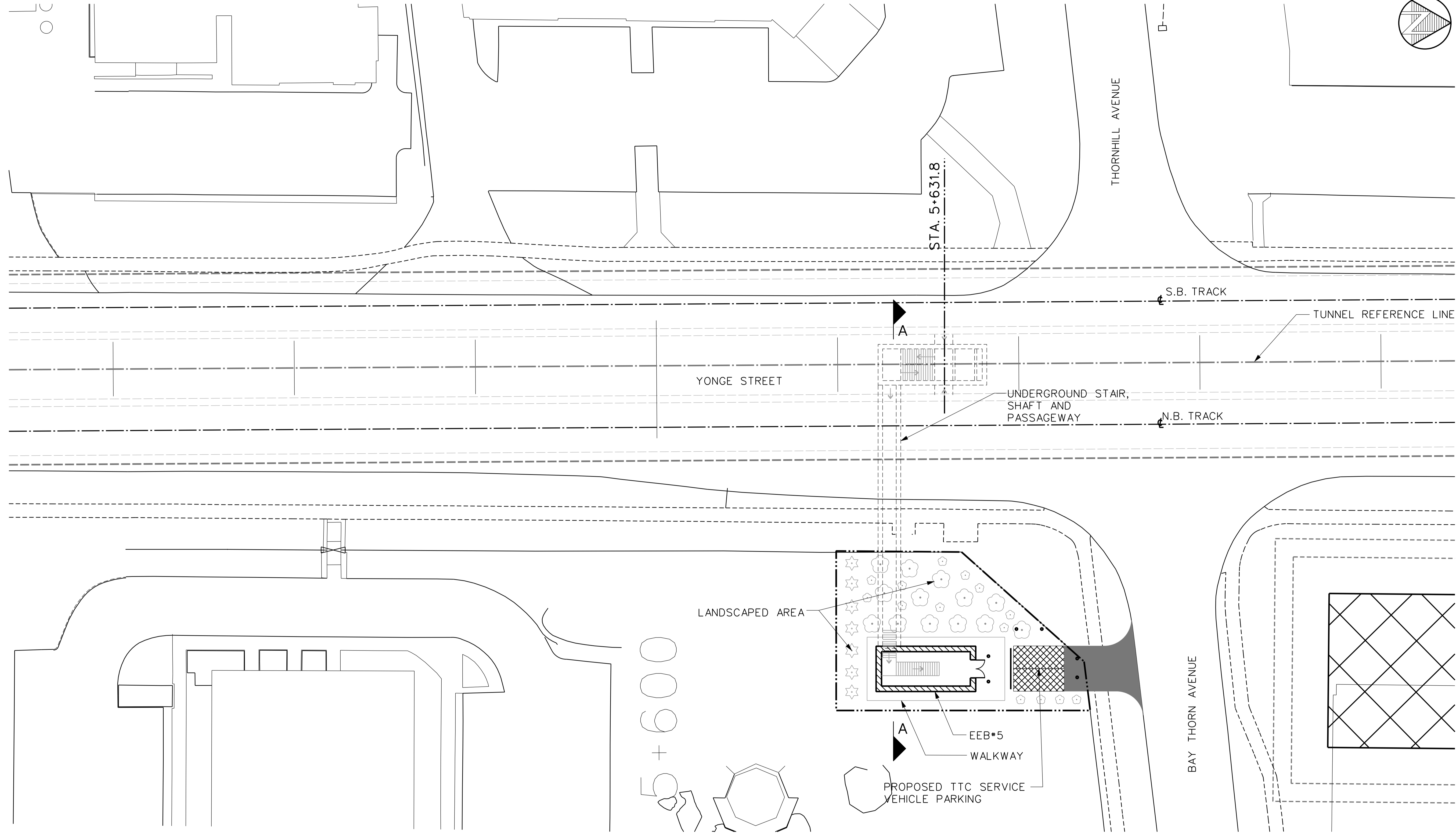
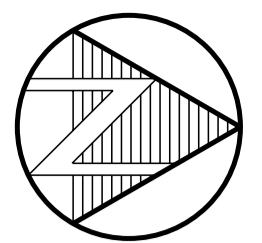

BLDG. REF. No.
FILE
SHEET No.

DRAWING No.

REVISIONS	REVISIONS
△	△
△	△
△	△

CONCEPTUAL DESIGN
NOT FOR CONSTRUCTION

Hatch Mott MacDonald
MCCORMICK RANKIN CORPORATION
A member of **MMM GROUP**

DRAWN
CHECKED
CORRECT

SCALE
0 1 2 3 4 5 8m

YONGE SUBWAY EXTENSION
CLARK STN. TO LANGSTAFF STN.
EMERGENCY EXIT BUILDING NO. 5
SITE PLAN

Plot Date: 11-08-23

TORONTO TRANSIT COMMISSION
ENGINEERING DEPARTMENT

Dwg. No. **SK-067** Sheet No. _____

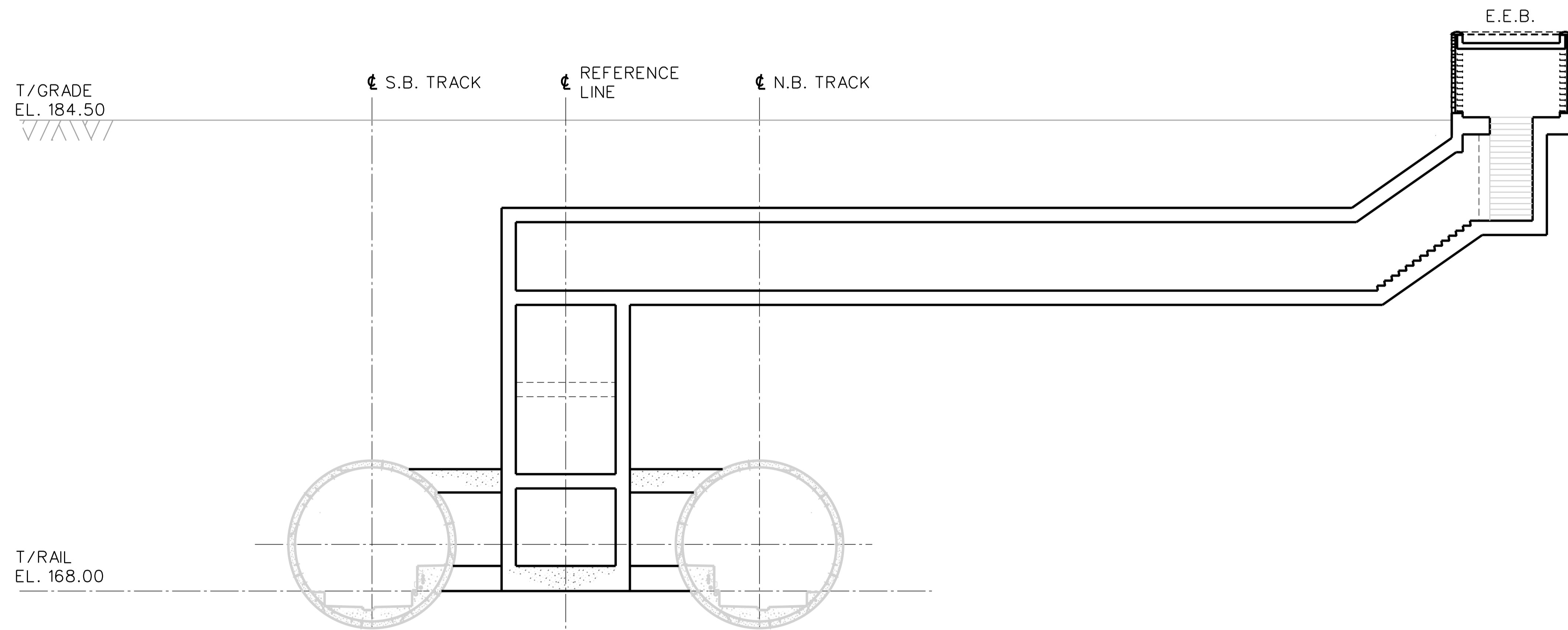

SECTION A-A THROUGH EEB #5
SCALE 1:200

BLDG. REF. No.
FILE
SHEET No.

REVISIONS	REVISIONS
△	△
△	△
△	△

CONCEPTUAL DESIGN
 NOT FOR CONSTRUCTION

Hatch Mott MacDonald

McCORMICK RANKIN CORPORATION
A member of **MMM GROUP**

DRAWN
 CHECKED
 CORRECT
 SCALE

YONGE SUBWAY EXTENSION
CLARK STN. TO LANGSTAFF STN.
 EMERGENCY EXIT BUILDING NO. 5
 SECTION

Plot Date: 11-08-23

TORONTO TRANSIT COMMISSION
 ENGINEERING DEPARTMENT
 Dwg. No. **SK-068** Sheet No.

DRAWING No.

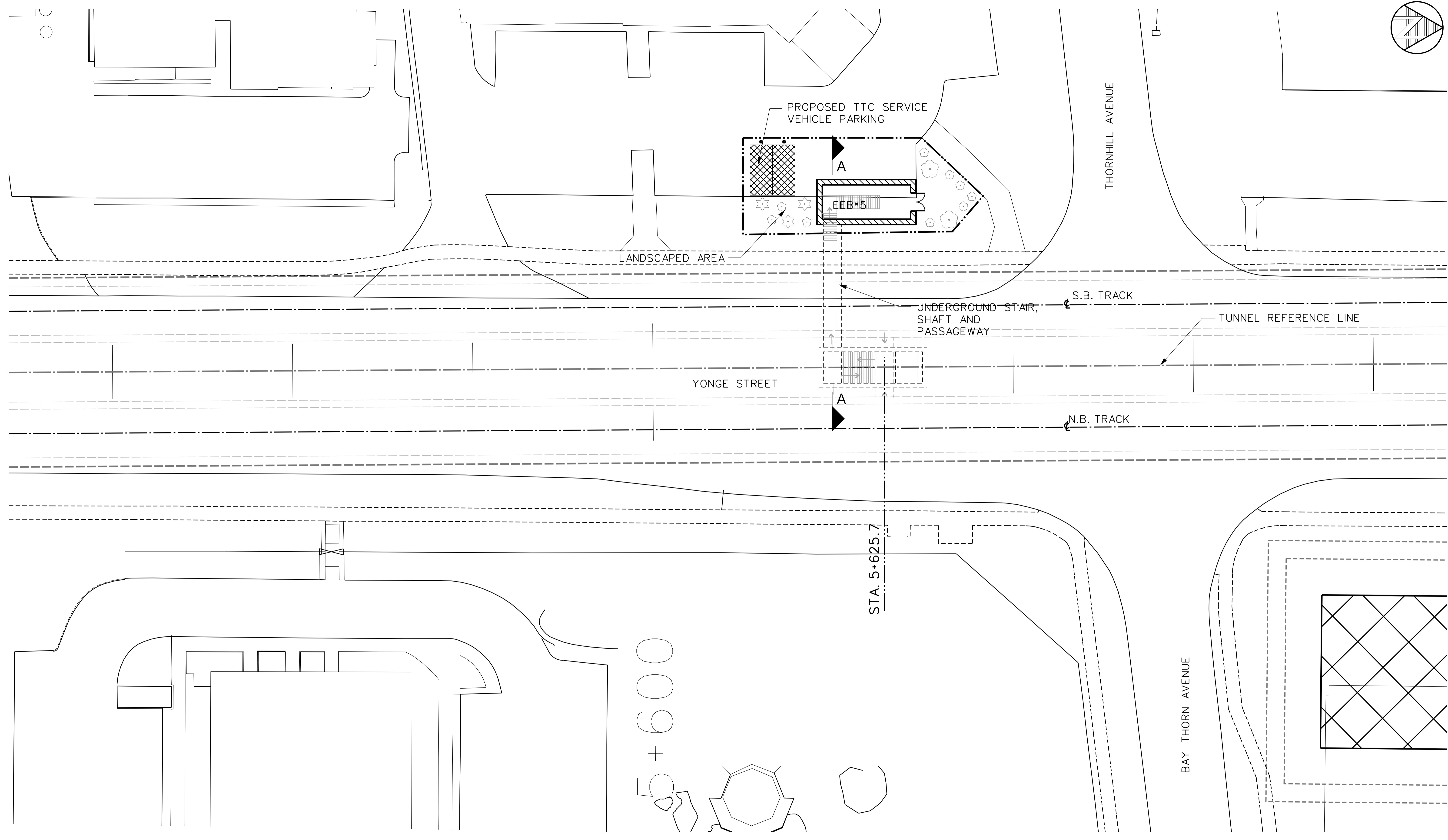
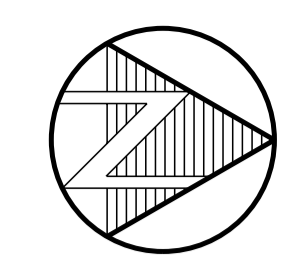

DRAWING No. SHEET No. FILE BLDG. REF. No.

REVISIONS	REVISIONS

CONCEPTUAL DESIGN
NOT FOR CONSTRUCTION

DRAWN
 CHECKED
 CORRECT

SCALE
 0 1 2 3 4 5 8m

YONGE SUBWAY EXTENSION
CLARK STN. TO LANGSTAFF STN.
 EMERGENCY EXIT BUILDING NO. 5
 SITE PLAN (OPTION 1)

Plot Date: 11-08-23

TORONTO TRANSIT COMMISSION
 ENGINEERING DEPARTMENT

Dwg. No. SK-069 Sheet No.

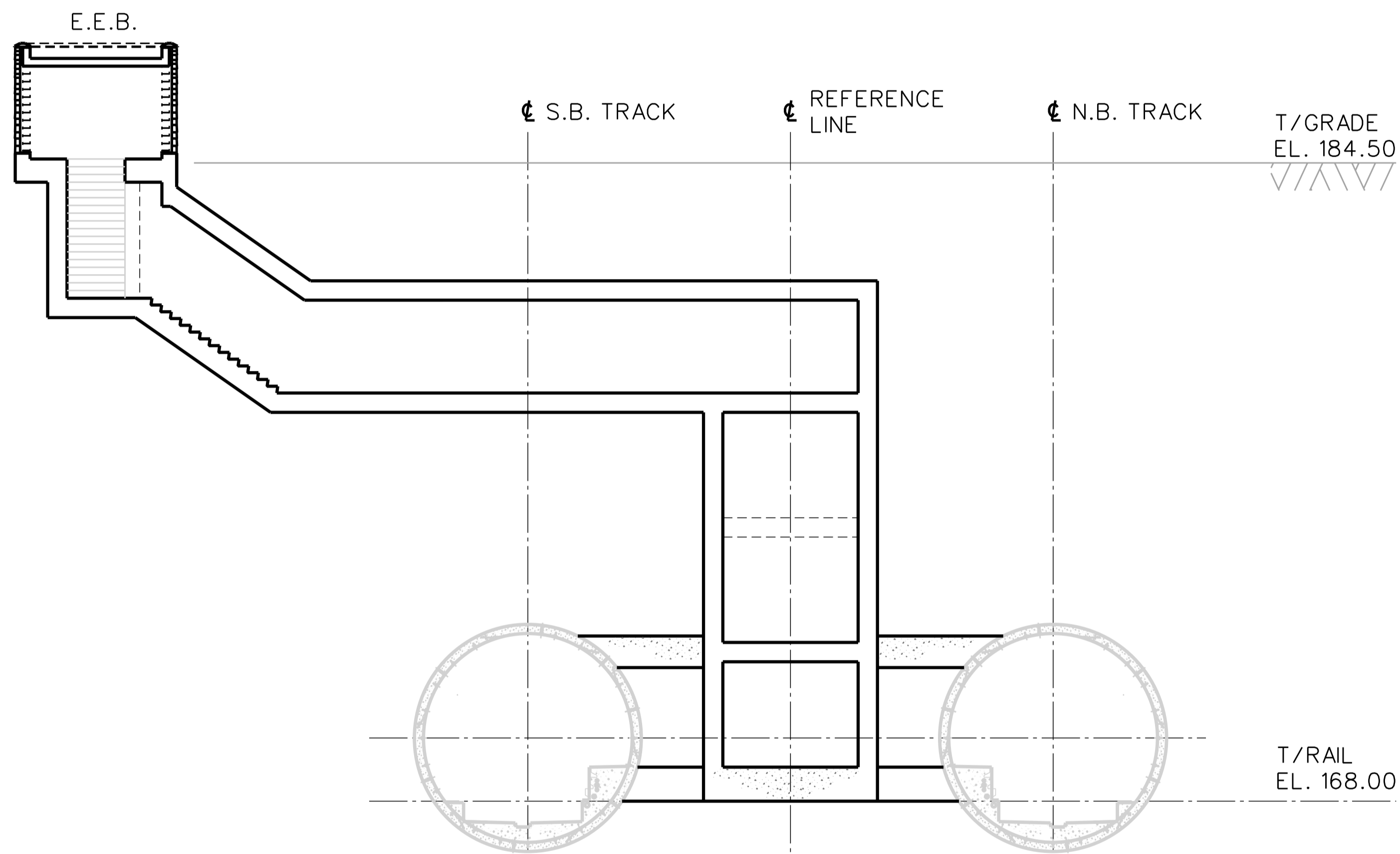

SECTION A-A THROUGH EEB #5
SCALE 1:200

BLDG. REF. No.
FILE
SHEET No.

DRAWING No.

REVISIONS	REVISIONS
△	△
△	△
△	△

**CONCEPTUAL
DESIGN**
 NOT FOR CONSTRUCTION

DRAWN
 CHECKED
 CORRECT
 SCALE

YONGE SUBWAY EXTENSION
CLARK STN. TO LANGSTAFF STN.
 EMERGENCY EXIT BUILDING NO. 5
 SECTION (OPTION 1)

Plot Date: 11-08-23

 TORONTO TRANSIT COMMISSION
 ENGINEERING DEPARTMENT
 Dwg. No. SK-070 Sheet No.

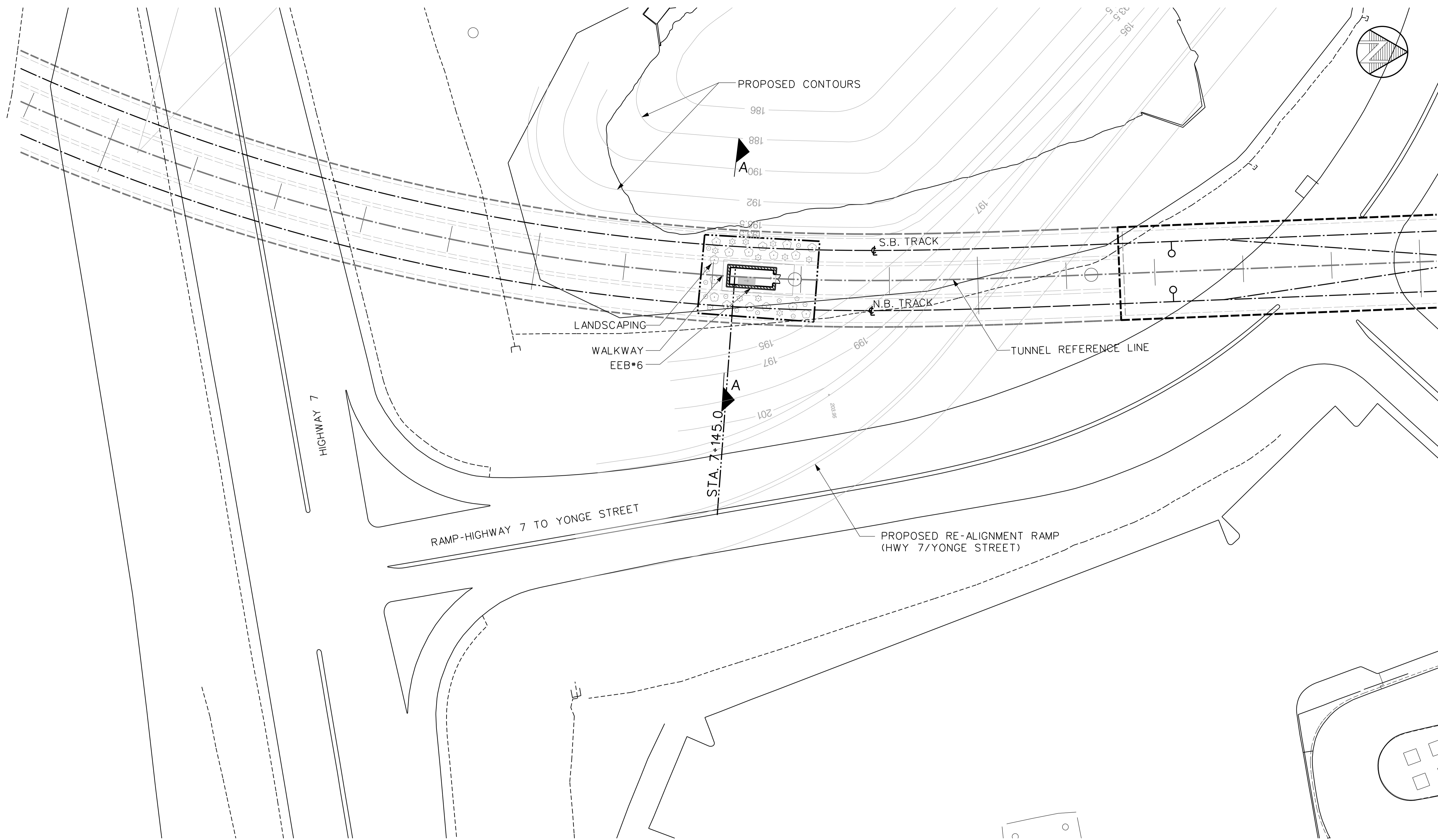

BLDG. REF. No.
 FILE
 SHEET No.
 DRAWING No.

REVISIONS	REVISIONS
△	△
△	△
△	△

CONCEPTUAL DESIGN
 NOT FOR CONSTRUCTION

DRAWN
 CHECKED
 CORRECT
 SCALE: 0 2 4 6 8 10 15m

YONGE SUBWAY EXTENSION
LANGSTAFF STATION TO RICHMOND HILL CENTER STN.
 EMERGENCY EXIT BUILDING NO. 6
 SITE PLAN

Plot Date: 11-08-23

 TORONTO TRANSIT COMMISSION
 ENGINEERING DEPARTMENT
 Dwg. No. SK-071 Sheet No.

BLDG. REF. No.
FILE
SHEET No.

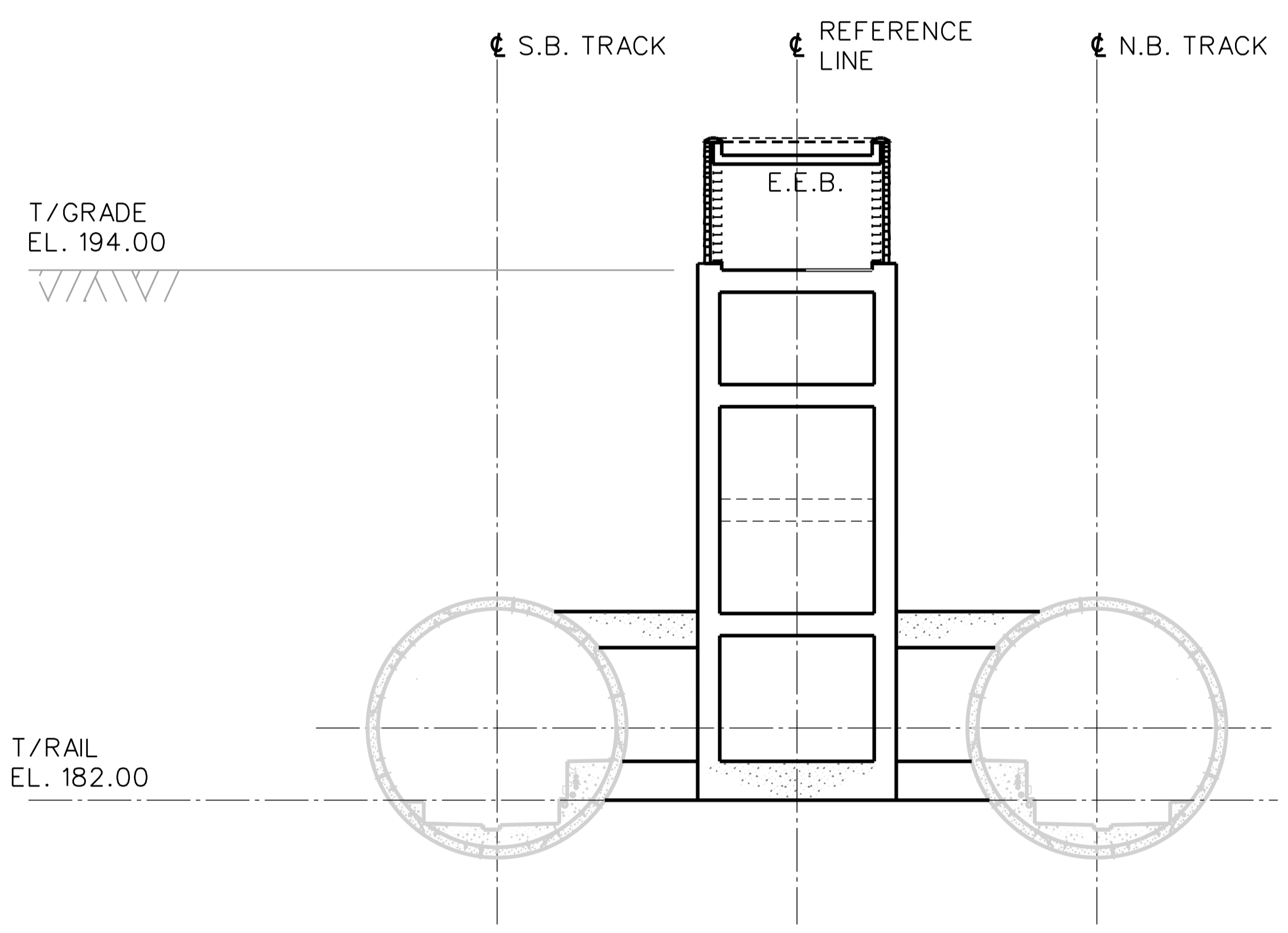

SECTION A-A THROUGH EEB #6
SCALE 1:200

DRAWING No.

REVISIONS	REVISIONS
△	△
△	△
△	△

CONCEPTUAL DESIGN
NOT FOR CONSTRUCTION

DRAWN

CHECKED

CORRECT

SCALE

YONGE SUBWAY EXTENSION

LANGSTAFF STATION TO RICHMOND HILL CENTER STN.

EMERGENCY EXIT BUILDING NO. 6

SECTION

Plot Date: 11-08-23

TORONTO TRANSIT COMMISSION
ENGINEERING DEPARTMENT

Dwg. No. SK-072

Sheet No.

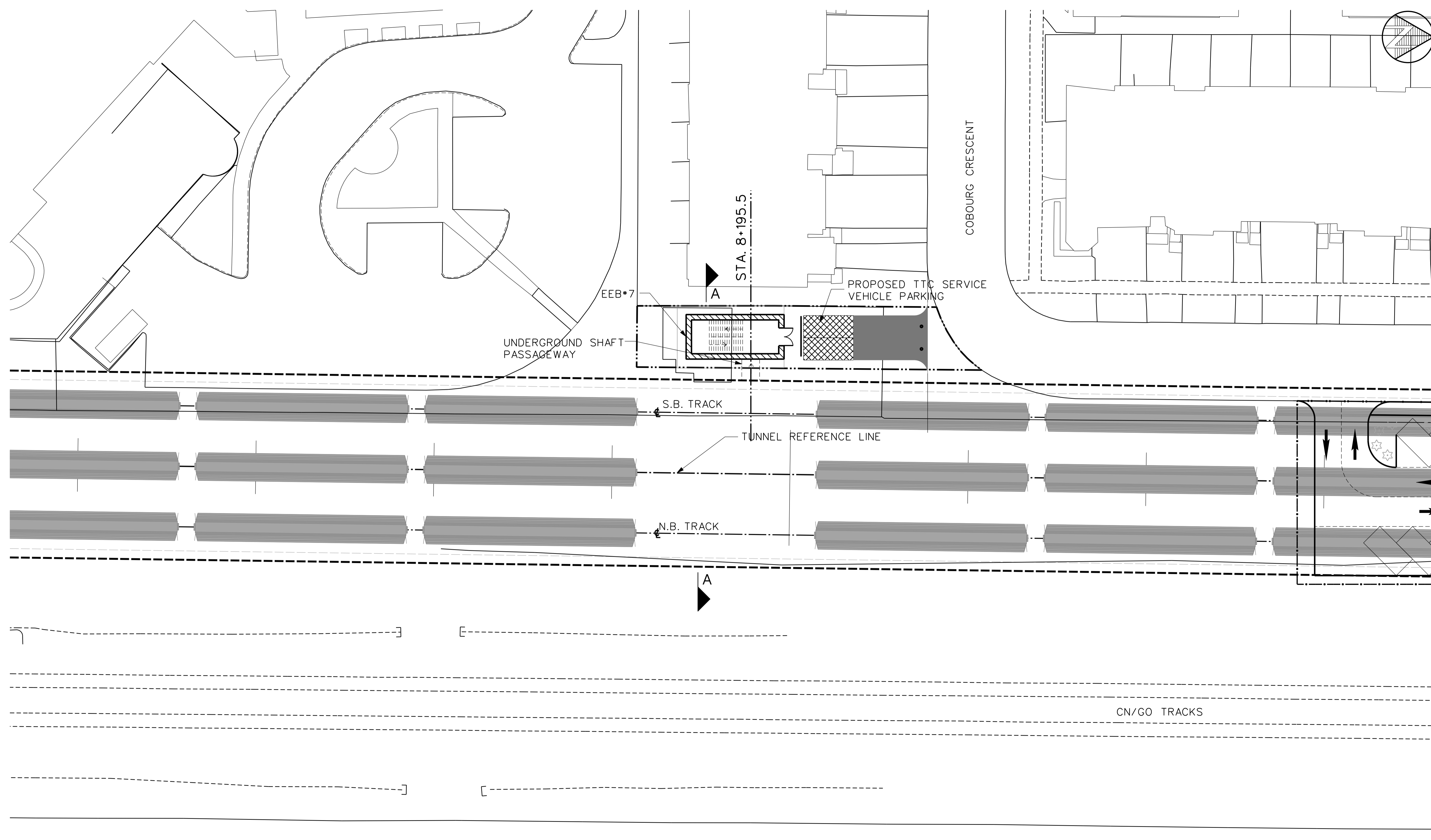

BLDG. REF. No.
FILE
SHEET No.

REVISIONS	REVISIONS

CONCEPTUAL DESIGN
NOT FOR CONSTRUCTION

Hatch Mott MacDonald
McCORMICK RANKIN CORPORATION
A member of **MMM GROUP**

DRAWN
CHECKED
CORRECT

SCALE
0 1 2 3 4 5 8m

YONGE SUBWAY EXTENSION
RICHMOND HILL CENTER STATION TO 16TH AVENUE STATION
EMERGENCY EXIT BUILDING NO. 7
SITE PLAN

Plot Date: 11-08-23

TORONTO TRANSIT COMMISSION
ENGINEERING DEPARTMENT

Dwg. No. **SK-073** Sheet No. _____

BLDG. REF. No.
FILE
SHEET No.

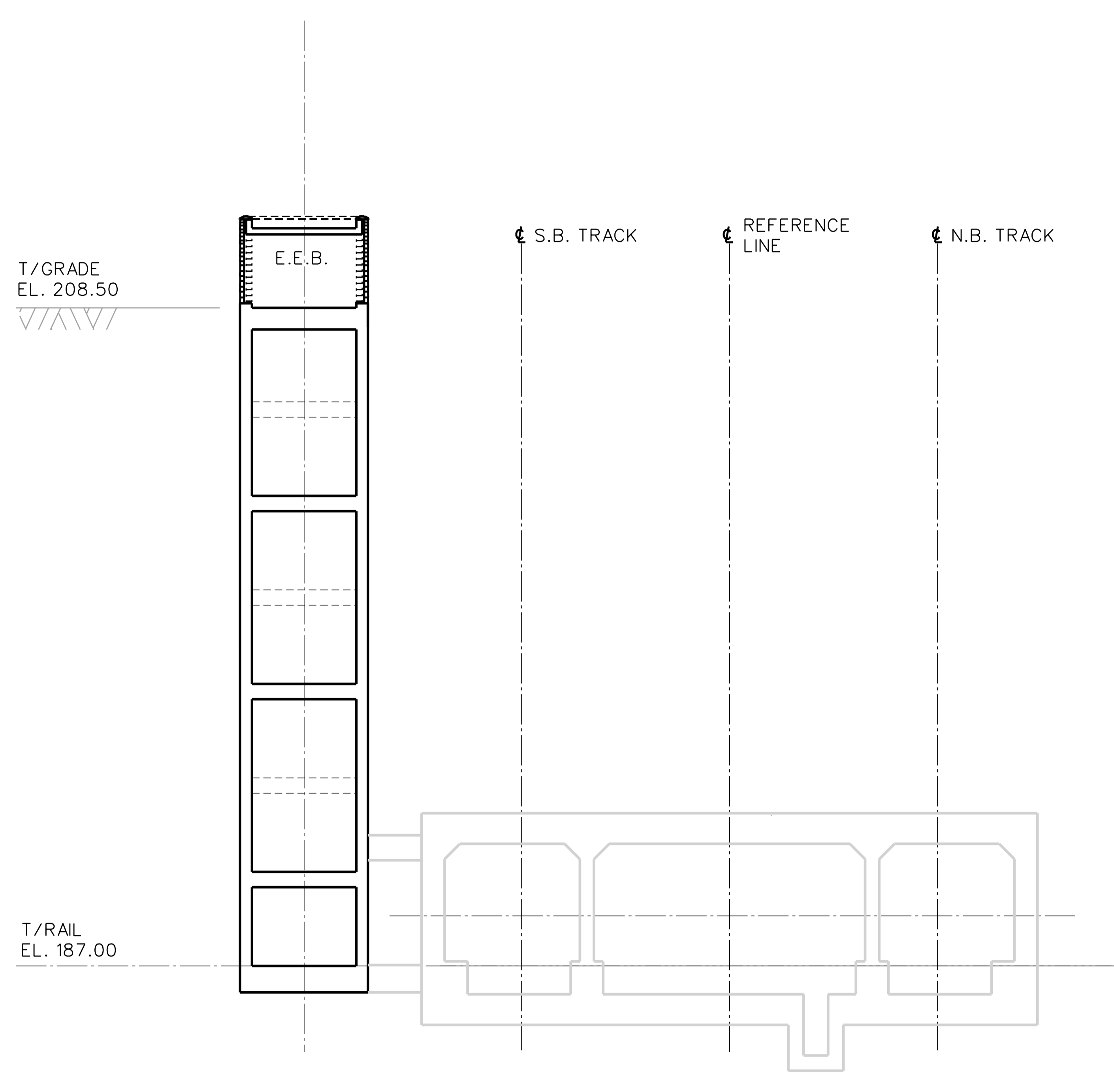

SECTION A-A THROUGH EEB #7
SCALE 1:200

REVISIONS	REVISIONS
△	△
△	△
△	△

CONCEPTUAL DESIGN
NOT FOR CONSTRUCTION

DRAWN
 CHECKED
 CORRECT

SCALE
 0 1 2 3 4m

YONGE SUBWAY EXTENSION
 RICHMOND HILL CENTER STATION
 TO 16TH AVENUE STATION
 EMERGENCY EXIT BUILDING NO. 7
 SECTION

Plot Date: 11-08-23

TORONTO TRANSIT COMMISSION
 ENGINEERING DEPARTMENT

Dwg. No. SK-074 Sheet No.

DRAWING No.

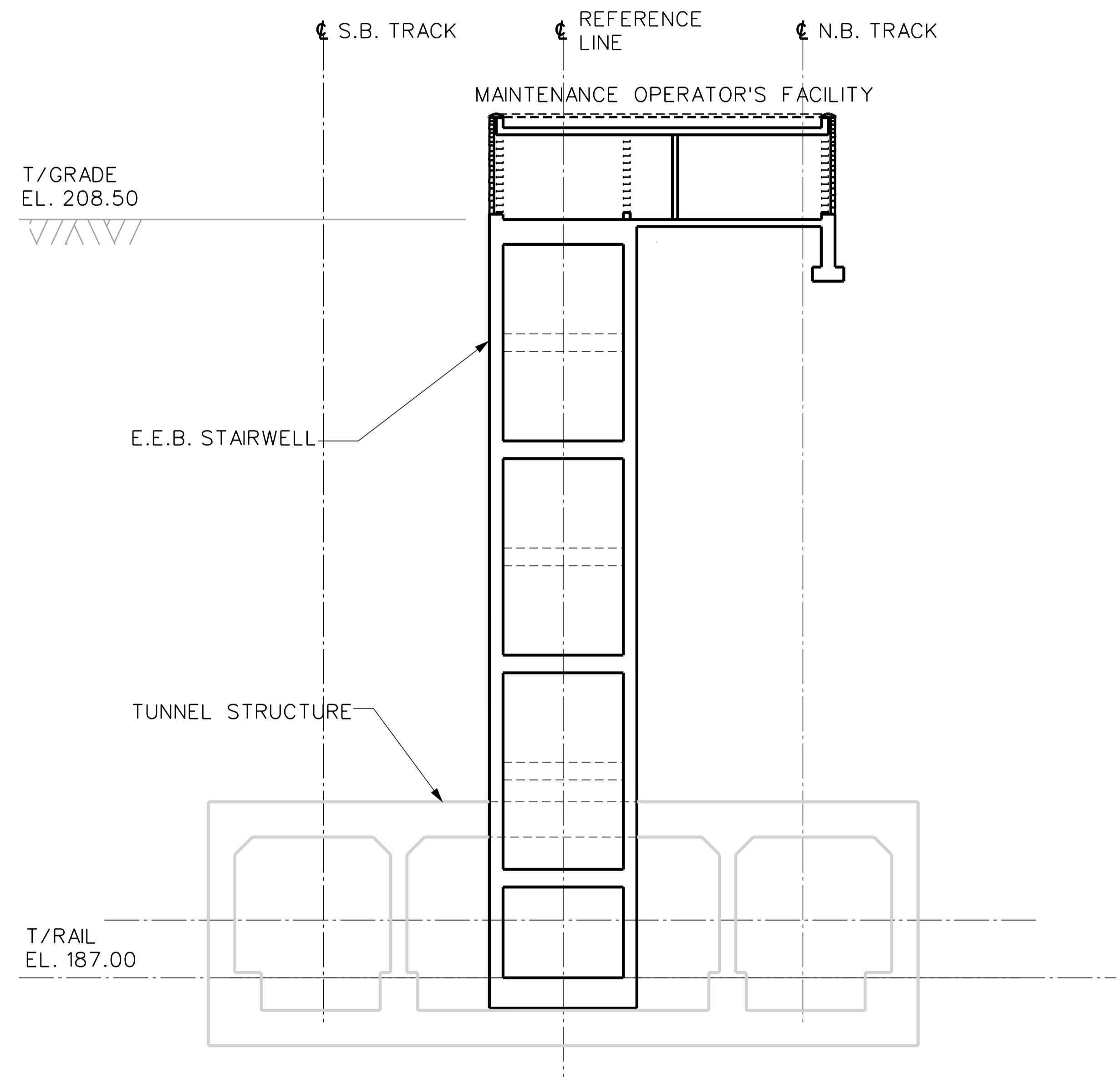

SECTION THROUGH EEB #8
SCALE 1:200

BLDG. REF. No.
FILE
SHEET No.

REVISIONS	REVISIONS
△	△
△	△
△	△

CONCEPTUAL DESIGN
 NOT FOR CONSTRUCTION

DRAWN
 CHECKED
 CORRECT
 SCALE

YONGE SUBWAY EXTENSION
**RICHMOND HILL CENTER STATION
 TO 16TH AVENUE STATION**
 EMERGENCY EXIT BUILDING No.8
 SECTION

Plot Date: 11-08-23

 TORONTO TRANSIT COMMISSION
 ENGINEERING DEPARTMENT
 Dwg. No. SK-075 Sheet No.

DRAWING No.